

DIGITAL 
PROJECTION

A Delta Associate Company

E-Vision Laser 11000 4K-UHD Series

High Brightness Digital Video Projector

INSTALLATION & QUICK START GUIDE

CONNECTION GUIDE

OPERATING GUIDE

REFERENCE GUIDE



About this document

Follow the instructions in this manual carefully to ensure safe and long-lasting use of the projector.

Symbols used in this document

Many pages in this document have a dedicated area for notes. The information in that area is accompanied by the following symbols:



WARNING: this symbol indicates that there is a danger of physical injury to yourself and/or damage to the equipment unless the instructions are closely followed.



ELECTRICAL WARNING: this symbol indicates that there is a danger of electrical shock unless the instructions are closely followed.



LASER WARNING: this symbol indicates that there is a potential hazard of eye exposure to laser radiation unless the instructions are closely followed.



NOTE: this symbol indicates that there is some important information that you should read.

Product revision

Because we at Digital Projection continually strive to improve our products, we may change specifications and designs, and add new features without prior notice.

Updates may be available online. Please visit the Digital Projection website for all latest documents.

Legal notice

Trademarks and trade names mentioned in this document remain the property of their respective owners. Digital Projection disclaims any proprietary interest in trademarks and trade names other than its own.

Copyright © 2019 Digital Projection Ltd. All rights reserved.

Notes

Laser information

Complies with FDA performance standards for laser products except for deviations pursuant to Laser Notice No. 50, dated June 24, 2007



LASER RADIATION
AVOID DIRECT EYE EXPOSURE
CLASS 3R LASER PRODUCT
 Emitted wavelength : 450-460 nm
 Max. Pulse energy: 0.34 mJ, Pulse duration: 0.65 ms

激光辐射 避免眼睛受到直接照射 3R类激光产品
 波长: 450-460 nm
 最大脉冲能量: 0.34 mJ, 脉冲时间: 0.65 ms

雷射輻射 避免眼睛受到直接照射 3R類激光產品
 波長: 450-460 nm
 最大脈衝能量: 0.34 mJ, 脈衝時間: 0.65 ms

RAYONNEMENT LASER
EXPOSITION DIRECTE DANGEREUSE POUR LES YEUX
APPAREIL À LASER DE CLASSE 3R
 longueur d'onde : 450-460nm
 maximum énergie de impulsion : 0.34 mJ,
 durée de impulsion : 0.65 ms

GB 7247.1-2012 / IEC/EN 60825-1:2007

CLASS 1 LASER PRODUCT PRODUIT LASER DE CLASSE 1
 IEC/EN 60825-1:2014 IEC/EN 60825-1:2014



Caution - use of controls or adjustments or performance of procedures other than those specified herein may result in hazardous radiation exposure.

Optical radiation



Caution - possibly hazardous optical radiation emitted from this product. Do not stare at operating light source. May be harmful to eyes. This projector is tested according to IEC/EN62471-5:2015 (Photobiological safety of lamps and lamp systems – Part 5: Image projectors standard) and is Risk Group 2 (low risk).

Notes

Introduction

Congratulations on your purchase of this Digital Projection product. Your projector has the following key features:

- 4K-UHD projector.
- Displays 4K-UHD with smooth picture processing.
- Support for Frame Sequential and Dual Pipe 3D formats.
- HDBaseT® for transmission of uncompressed High Definition Video up to 100 m from the source.
- 3G-SDI with loop-through.
- Edge Blend with black level correction.
- Blanking control for custom input window sizing.
- Cornerstone, Vertical & Horizontal Keystone, Pincushion & Barrel, and Image Rotation.
- Control via LAN and RS232.
- Motorised lens mount.
- Separate control of screen and source aspect ratio.

A serial number is located on the side of the projector. Record it here:

Notes

Contents	
About this document	2
Symbols used in this document	2
Product revision	2
Legal notice	2
Laser information	3
Optical radiation	3
Introduction	4
Contents	5
What's in the box?	10
Connecting the power supply	11
Voltage selection	11
Projector overview	12
Control panel	13
Projector indicators	14
Remote control	15
Infrared reception	18
Positioning the screen and projector	19
Roll and pitch	20
Changing the lens	21
Inserting a new lens	21
Removing the lens	21
Operating the projector	22
Switching the projector on	22
Switching the projector off	22
Selecting an input signal	22
Selecting a test pattern	22
Adjusting the lens	23
Lens menu	23
Remote control	23
Adjusting the image	23
Orientation	23
Geometry	23
Picture	23
Signal inputs	26
Digital inputs and outputs	26
EDID on the DisplayPort, HDMI, and HDBaseT inputs	27
Using DisplayPort/ HDMI/ HDBaseT switchers with the projector	27
3D connections	28
Frame sequential 1080p 3D up to 120Hz and WUXGA 3D at 100Hz	28
Dual Pipe 1080p, WUXGA and WQXGA+ 3D sources at up to 100 and 120Hz	28
3D Sync	29
Control connections	30
LAN connection examples	31
RS232 connection example	32
Using the menus	34
Opening the Menu	34
Opening a submenu	34
Exiting menus and closing the OSD	35
Inside a menu	35
Accessing sub menus	36
Executing commands	36

Notes

Editing projector settings	37	Top right corner example	58
Using a slider to set a value	37	Rotation	59
Editing numeric values	38	Rotation example	60
Using the projector	39	Pincushion / barrel	61
Main menu	39	Pincushion/ Barrel example	61
Lens menu	40	Arc	62
Lens control	40	Custom warp	63
Lens memory	41	Edge blend menu	64
Image menu	42	Blend width	65
Color menu	44	Black level uplift	66
Color space	44	3D menu	67
Color mode	45	3D types	68
ColorMax	45	Some 3D settings explained	69
Manual color matching	46	Dark time	69
Color matching parameters explained	47	Eye swap	69
Color temperature	48	Sync offset	70
Gains and lifts	48	Laser menu	71
Geometry menu	49	Setup menu	72
Aspect ratio	49	ColorMax	74
Theaterscope setting	50	Measured data/ target data	74
Digital zoom	51	Power on / off	75
Overscan	52	Clock adjust	76
Blanking	53	OSD settings	76
Keystone	54	Memory	77
Keystone example	55	Network menu	78
Keystone settings	56	PIP menu	79
4 corners	57	Information menu	80

Notes

Signal format	80	Appendix A: supported signal input modes	109
System status	81	2D formats	109
Thermal status	81	3D formats	112
Factory reset	82	SDI formats	113
Served web pages	83	Appendix B: wiring details	114
Choosing a lens	96	Signal inputs and outputs	114
Basic calculation	97	HDMI 1 and 2	114
Basic calculation example	98	DisplayPort	115
Full lens calculation	99	3G-SDI in, 3G-SDI out	116
Introducing TRC	99	HDBaseT input	116
Calculating TRC	100	Control connections	117
TRC table	100	LAN	117
Calculating the throw ratio with TRC	100	RS232	117
Full lens calculation example	101	IR input	117
Screen requirements	102	Appendix C: glossary of terms	118
Fitting the image to the display	102		
4K-UHD images displayed full width	102		
4K-UHD images displayed with a height of 2160 pixels	102		
4K-UHD images displayed full height	103		
Diagonal screen sizes	103		
Positioning the image	104		
Aspect ratios explained	106		
Aspect ratios examples	106		
Source: 4:3	106		
Source: 16:9	107		
Source: 16:10 (native)	107		
Aspect ratio example: TheatreScope	108		

Notes

This page is intentionally left blank

DIGITAL 
PROJECTION

A Delta Associate Company

E-Vision Laser 11000 4K-UHD Series

High Brightness Digital Video Projector

INSTALLATION & QUICK START GUIDE



What's in the box?

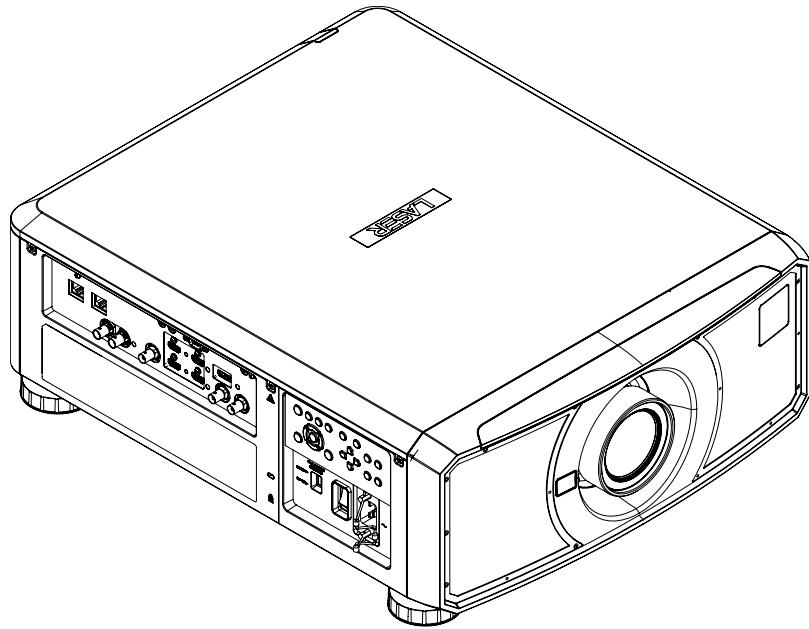

Projector

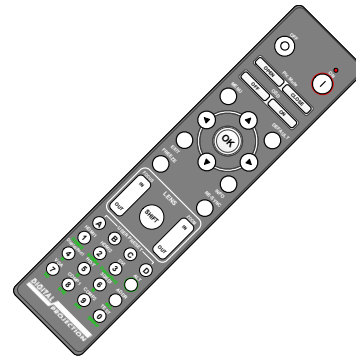

Remote Control

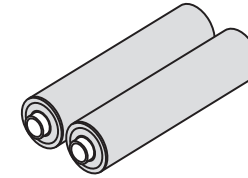

Batteries

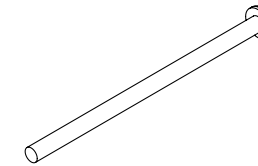

Security Screw

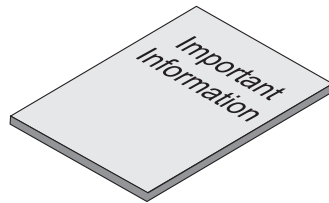

Important Information Book

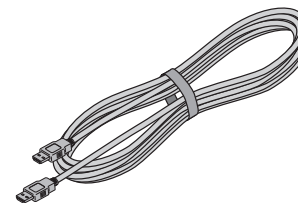

HDMI Cable

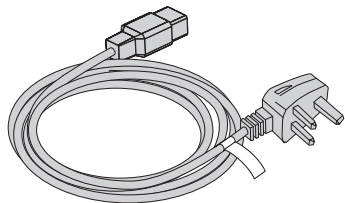

Power Cable, UK

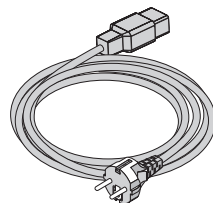

Power Cable, Europe

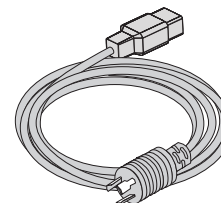



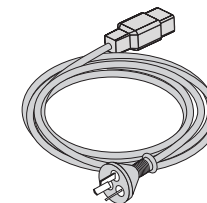

Power Cable, North America



Power Cable, China

Notes



-  *Make sure your box contains everything listed. If any pieces are missing, contact your dealer.*
-  *Only one remote is supplied with the projector.*
-  *Save and store the original box and packing materials, in case you ever need to ship your projector.*
-  *The projector is shipped without a lens.*
-  *Only the appropriate cable for destination territory is supplied with the projector*

Connecting the power supply

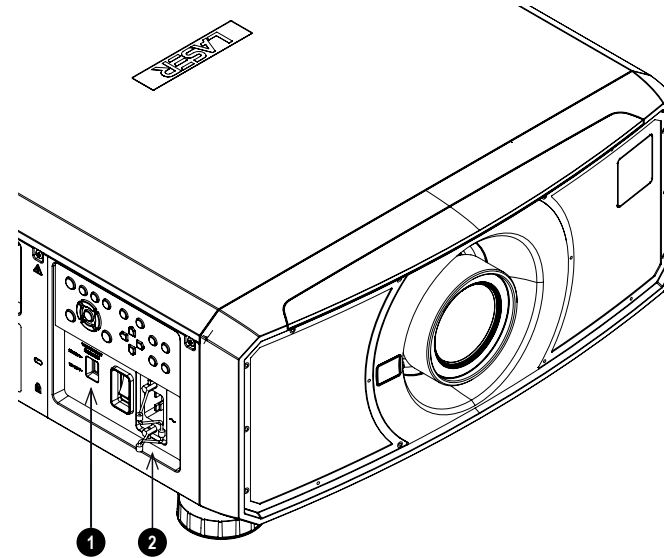
1. Adjust the VOLTAGE SELECT switch to the required voltage **1**
2. Firmly push the mains connector into the socket **2**





Notes

-  Use only the power cable provided.
-  Ensure that the power outlet includes a ground connection as this equipment **MUST** be earthed.
-  Handle the power cable carefully and avoid sharp bends. Do not use a damaged power cable.

Voltage selection

The VOLTAGE SELECT switch must be set to match the power supply you are using:

Voltage of power supply used	Position of VOLTAGE SELECT switch
AC100-130V outlet	200 240V~  100 130V~
AC200-240V (single phase) outlet	200 240V~  100 130V~

Projector overview

1. Air inlet
2. Front infrared window
3. Lens mount
4. Air inlet
5. Rear infrared window
6. Air outlet
7. Connections panel
8. Control panel
9. Adjustable feet
10. Voltage selector
11. Mains socket and switch
12. Air inlets

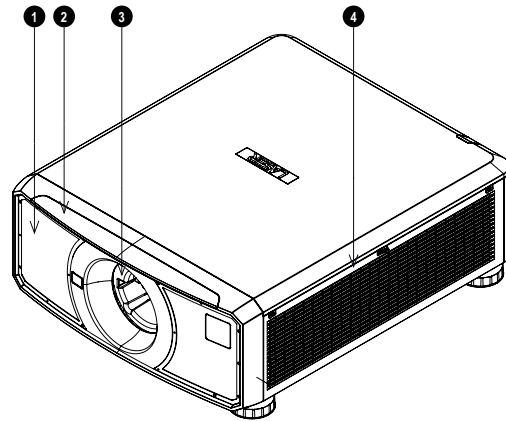

Front View

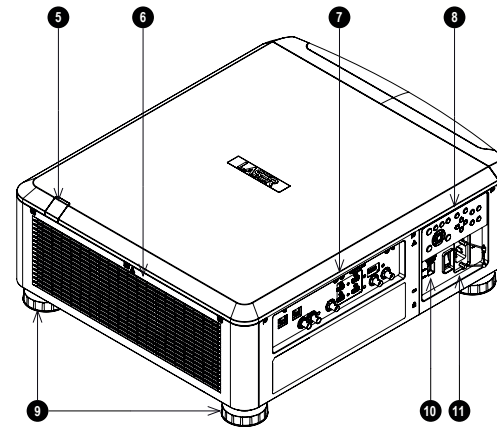

Rear View

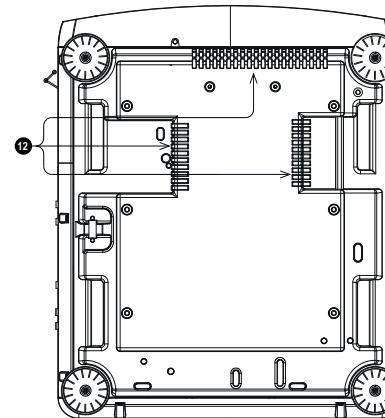

Bottom View

Notes

Control panel

1. **POWER**
Switches the projector on and off (STANDBY).
2. **INPUT**
Switches to the next input source.
3. **AUTO SYNC**
Re-synchronises with the current input signal.
4. **ASPECT**
Changes the aspect ratio.
5. **CENTER LENS**
Centers the lens.
6. **PIC MUTE** Shows and hides the projected image. When muted, the light source is completely switched off and the screen is black.
7. **MENU**
Displays and exits the OSD.
8. **Arrow buttons & ENTER**
Navigation buttons used to highlight menu entries in the OSD. Press **ENTER** to open or execute the highlighted menu entry.
9. **EXIT**
Exits the current OSD page and enters the level above.
10. **LENS SHIFT**
Arrow buttons move the lens in the specified direction.
11. **FOCUS**
Plus and minus buttons move the focus in and out.
12. **ZOOM**
Plus and minus buttons zoom in and out.

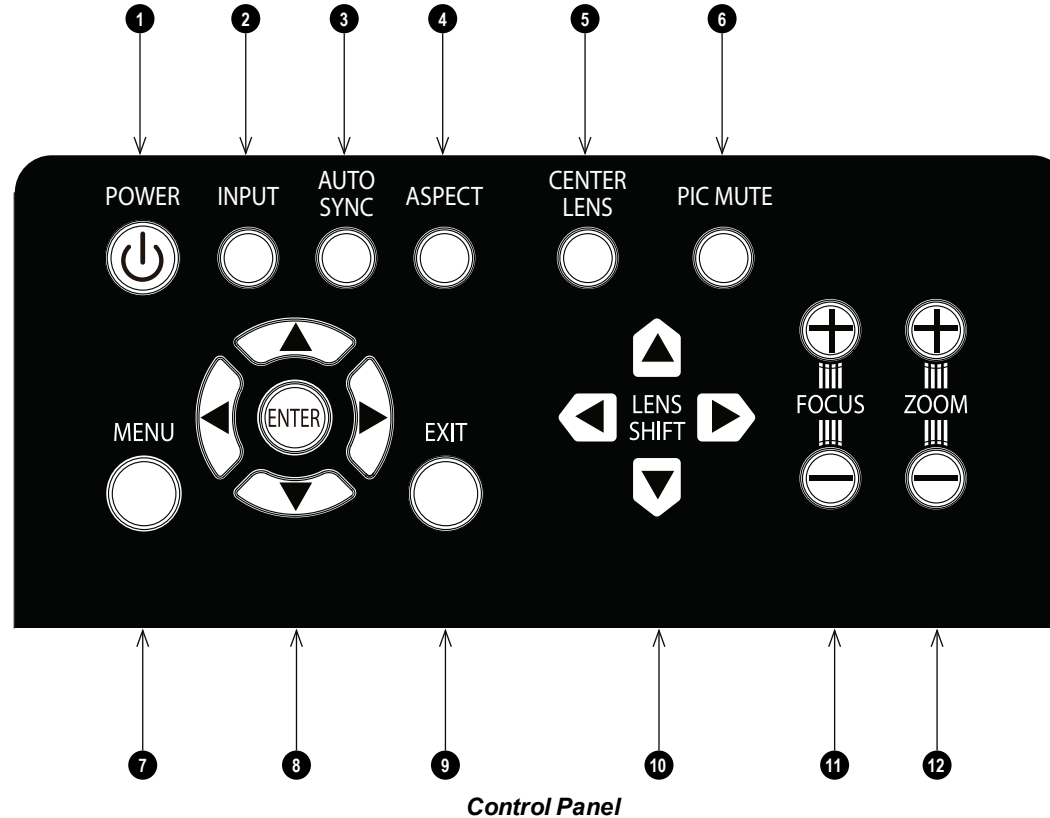

Notes

 *AUTO SYNC and ASPECT do not work when the projector uses HDMI 3 or 4.*

Projector indicators

- TEMP.** Off = no problem
Flashing red = temperature error
- LIGHT** Off = light is switched off
Flashing green = light is preparing to switch on
Flashing red (cycles of six flashes) = light module failure
On, red = light module has reached end of life
On, green = light is switched on
- STATUS** Off = no problem
Flashing red (continuously) = cover error
Flashing red (cycles of four flashes) = fan error
On, red = system error
- POWER** Off = the projector is switched off
Flashing green = the projector is warming up
Flashing amber = the projector is cooling down
On, red = STANDBY mode
On, green = the projector is switched on

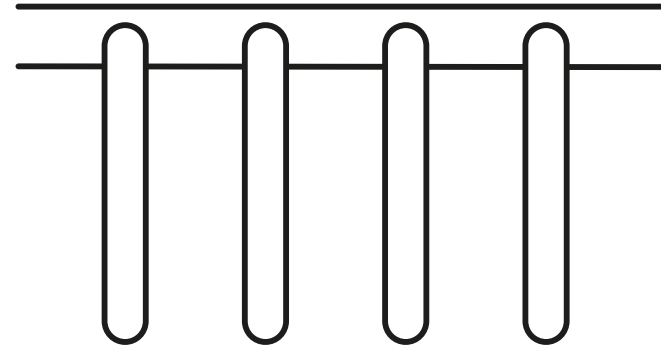

TEMP. LIGHT STATUS POWER

Indicators

Notes

Remote control

1. **Power ON / OFF**
Turns power on and off.
2. **Pic Mute OPEN / CLOSE**
Shows and hides the projected image.
When OFF, the light source is completely switched off and the screen is black.
3. **OSD ON / OFF**
Enable and disable screen timeout messages and control whether to show the OSD during projection.
4. **MENU**
Access the OSD. If the OSD is open, press this button to go back to the previous menu.
5. **Navigation (arrows and OK)**
Navigate through the menus with the arrows, confirm your choice with **OK**.
In lens adjustment modes, the arrows are used to move, zoom or focus the lens.
See 11 below. In lens adjustment modes, or when the OSD is not showing, the OK button switches between modes: **Shift Adjustment** and **Zoom / Focus Adjustment**.
6. **EXIT**
Go up one level in the OSD. When the top level is reached, press to close the OSD.
7. **FREEZE**
Freeze the current frame.
8. **DEFAULT**
When editing a parameter, press this button to restore the default value.
9. **INFO**
Access information about the projector.
10. **RE-SYNC**
Re-synchronise with the current input signal

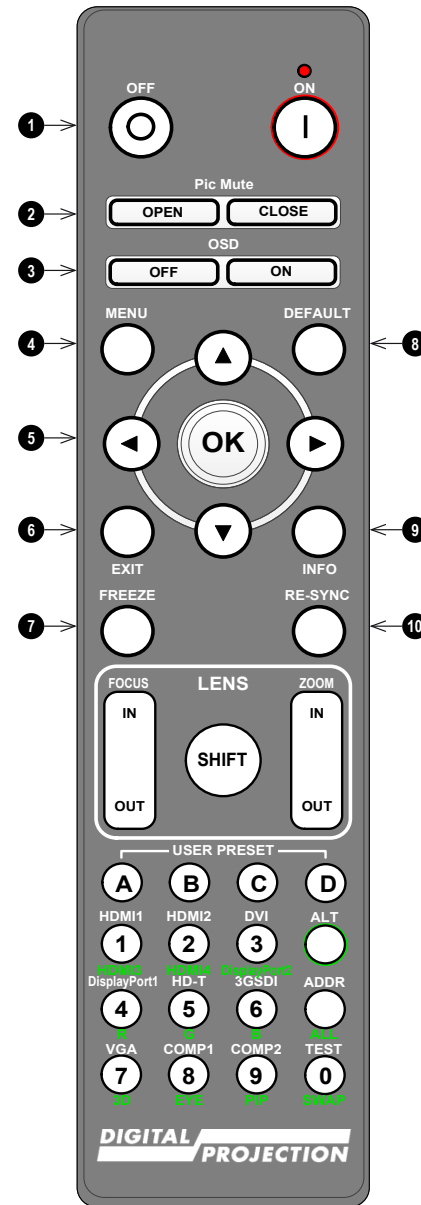

Remote Control

Notes

FREEZE and RE-SYNC are not available when the projector uses input HDMI 3 or 4.

11. **LENS adjustment**

- **FOCUS IN / OUT:** adjust focus.
- **SHIFT:** press and hold this button, then use the Navigation arrow buttons to move the lens.
- **ZOOM IN / OUT:** adjust zoom.

12. **USER PRESET A, B, C, D**

Load user presets.

13. **ALT**

Press and hold this button to access alternative functions for all buttons with a green label.

14. **DVI / DisplayPort2 / numeric input 3**

There is no DVI input on this projector.
Use with **ALT** to select the DisplayPort 2 input.

15. **HDMI 2 / HDMI 4 / numeric input 2**

Select the HDMI 2 input.
Use with **ALT** to select the HDMI 4 input. There is no HDMI 4 input on this projector

16. **HDMI 1 / HDMI 3 / numeric input 1**

Select the HDMI 1 input.
Use with **ALT** to select the HDMI 3 input. There is no HDMI input on this projector

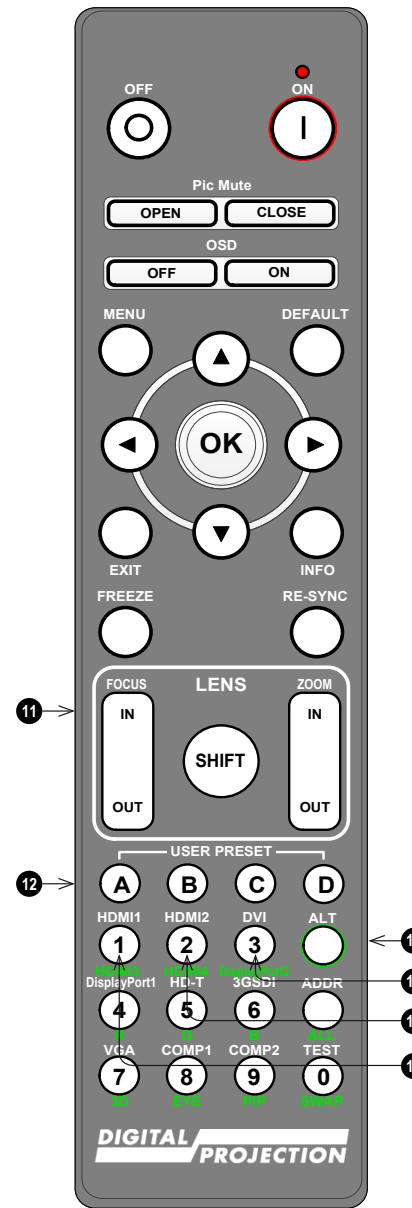

Remote Control

Notes

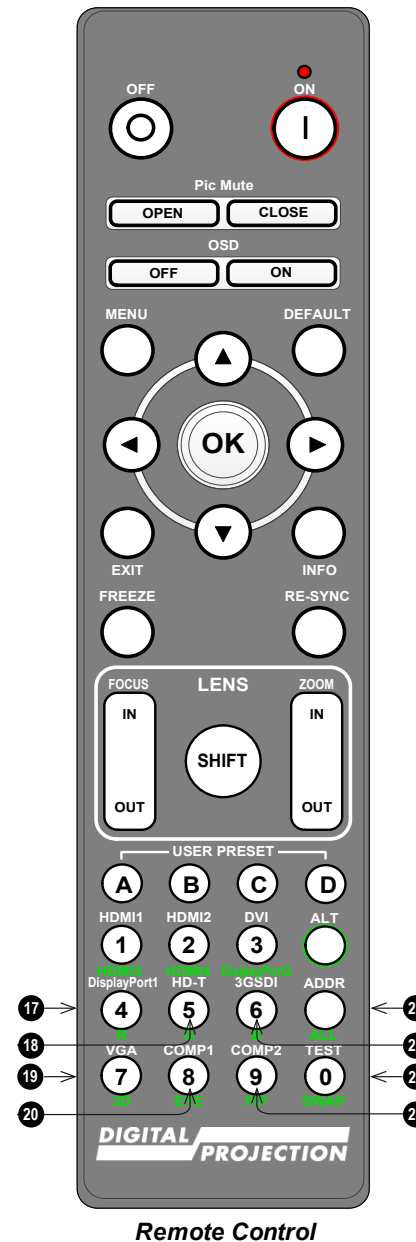

- This projector does not use the following options on the remote: DVI, VGA, COMP 1 and COMP 2.
- 3D is only available on the HDMI 3 and 4 inputs.

17. **DISPLAYPORT 1 / R / numeric input 4**
Select DisplayPort 1 input.
18. **HD-T / G / numeric input 5**
Select the HDBaseT input.
19. **VGA / 3D / numeric input 7**
There is no VGA input on this projector.
Use with **ALT** to toggle the 3D Format setting between Off and Auto.
20. **COMP1 / EYE / numeric input 8**
There is no Component 1 input on this projector.
Use with **ALT** to switch between left and right eye 3D dominance.
21. **ADDR / ALL (with red indicator at the top)**
Assign and unassign an IR remote address.
 - **To assign an IR remote address:**
 1. Press and hold this button until the red indicator starts flashing.
 2. Release this button and while the red indicator is still flashing, enter a two-digit address using the numeric input buttons. The indicator will flash three times quickly to confirm the change.
 - **To unassign an address and return to the default address 00:**
 1. Press and hold ALT and this button simultaneously until the red indicator flashes to confirm the change.
22. **3GSDI / B / numeric input 6**
Select the 3G-SDI input.
23. **TEST / SWAP / numeric input 0**
Show a test pattern. Press again to show the next test pattern: *White, Black, Red, Green, Blue, Checkerboard, Crosshatch, V Burst, H Burst, Color Bar, Screen Layout, Off.*
When **PIP** mode is on, use this button with **ALT** to swap the main and sub images.
24. **COMP2 / PIP / numeric input 9**
There is no Component 2 input on this projector.
Use with **ALT** to switch on **Picture In Picture (PIP)** mode.



Remote Control

Notes

-  This projector does not use the following options on the remote: DVI, VGA, COMP 1 and COMP 2.
-  3D is only available on the HDMI 3 and 4 inputs.
-  PIP is not available when the projector uses input HDMI 3 or 4.

Infrared reception

The projector has infrared sensors at the front and back.

The angle of acceptance is 40° . Make sure that the remote control is within the angle of acceptance when trying to control the projector.

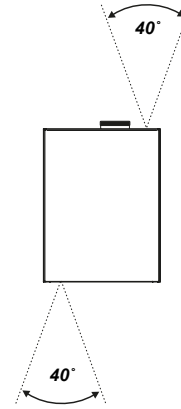

Notes

Positioning the screen and projector

1. Install the screen, ensuring that it is in the best position for viewing by your audience.
2. Mount the projector, ensuring that it is at a suitable distance from the screen for the image to fill the screen. Set the adjustable feet so that the projector is level, and perpendicular to the screen.

The drawing shows the positions of the feet for table mounting, and the fixing holes for ceiling mounting.

1. Four adjustable feet
2. **Six M4 holes for ceiling mount** The screws should not penetrate more than 15 mm into the body of the projector.

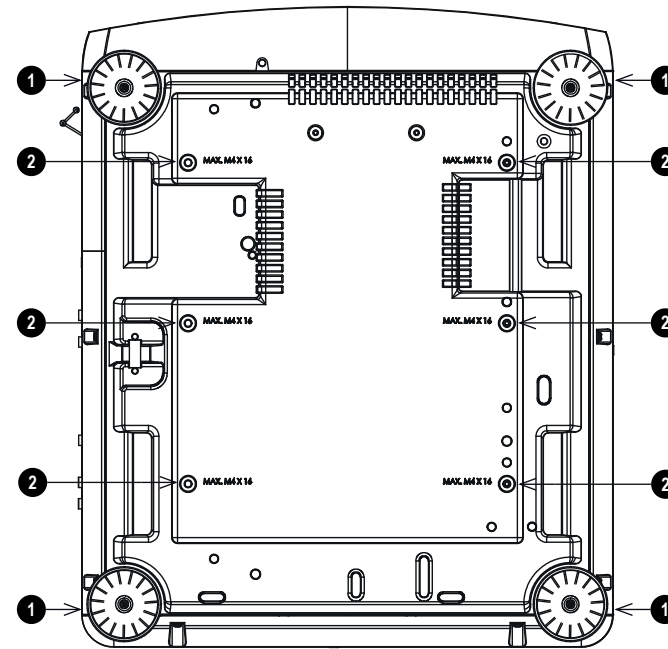

Notes

Always allow the projector to cool for 5 minutes before disconnecting the power or moving the projector.

Ensure that there is at least 50 cm (19.7 in) of space between the ventilation outlets and any wall, and 30 cm (11.8 in) on all other sides.

Do not use the threaded holes for the adjustable feet to hang or mount the projector.

Roll and pitch

The projector can be operated in numerous positions.

In portrait mode, it is recommended to position the projector with inputs facing upward, as shown in the diagram.

1. Recommended positions: inputs side up
2. Also possible.

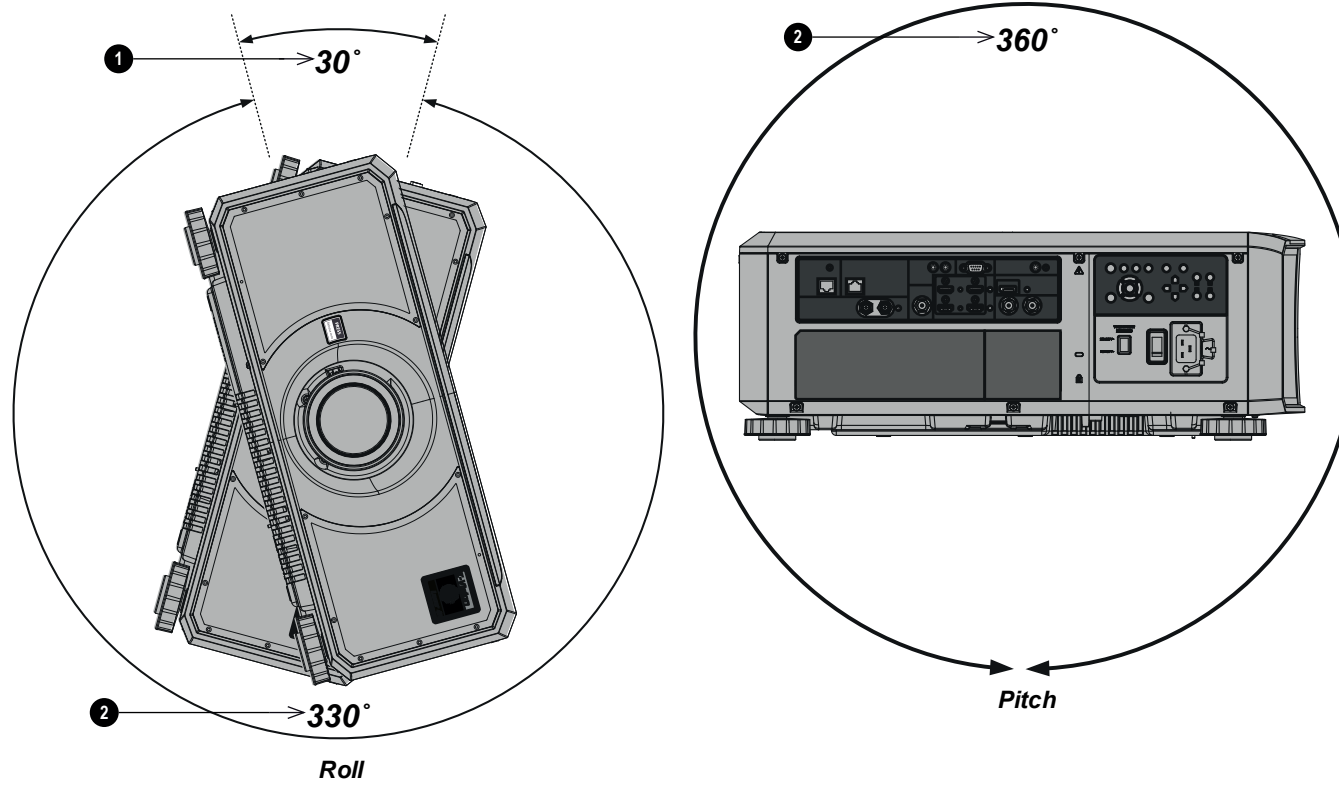

Notes

Changing the lens

Inserting a new lens

1. Remove the lens aperture cap from the projector.
2. Remove the front and rear lens caps from the lens.
3. Position the lens so that the labels are at the top, and gently insert it all the way into the lens mount.
4. Push the lens in firmly and turn it clockwise until it clicks into place.

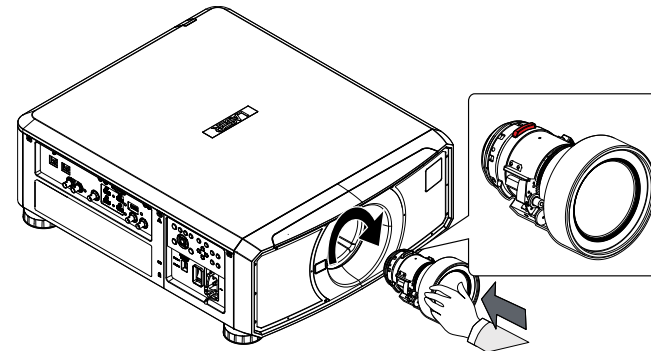
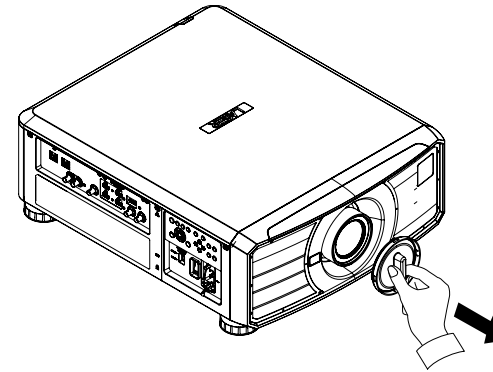

Removing the lens

1. Push the lens release button all the way in
2. Turn the lens anti-clockwise until it disengages
3. Slowly remove the lens.

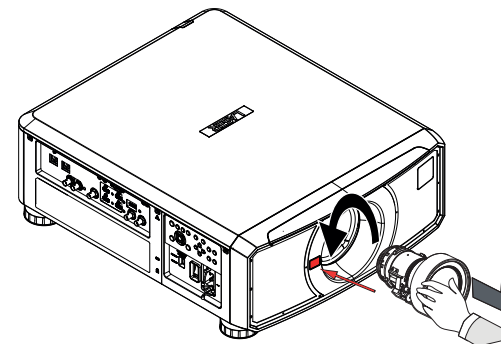

Notes



Before changing the lens, always make sure the projector is switched off and fully disconnected from its power supply.



When changing the lens, avoid using excessive force as this may damage the equipment.



Avoid touching the surface of the lens as this may result in image impairment.



The lens is shipped separately.



Take care to preserve the original lens packaging and protective caps for future use.



The projector will not power on without the lens fitted.

Operating the projector

Switching the projector on

1. Ensure a lens is fitted. Connect the power cable between the mains supply and the projector. (See Connecting the power supply above.) Switch on at the switch next to the power connector.
2. The **POWER** indicator lights red to signal that the projector is in STANDBY mode. Press one of the following buttons:
 - On the remote control, the **ON** button
 - On the projector control panel, the **POWER** button.

The fans begin working, then the **POWER** indicator begins flashing green. When the flashing stops, the **POWER** and **LIGHT** indicators both light steady green. The projector is switched on.

Switching the projector off

1. Press **OFF** on the remote control or **POWER** on the control panel, then press again to confirm your choice. The **POWER** indicator on the control panel will start flashing amber, the system will go out and the cooling fans will run for a short time until the **POWER** indicator goes steady red to indicate that the projector has entered STANDBY mode.
2. If you need to switch the projector off completely, switch off at the mains power switch next to the power connector and then disconnect the power cable from the projector.

Selecting an input signal

1. Connect one or more image sources to the projector.
2. Select the input you want to display:
 - Press one of the input buttons on the remote control.
 - Alternatively, open the On-screen display (OSD) by pressing **MENU**. Highlight **Input** from the main menu, press **ENTER/OK** and then select an input signal using the **UP** and **DOWN** arrow buttons. Press **ENTER/OK** to confirm your choice.

Selecting a test pattern

To display a test pattern:

- Press **TEST** on the remote control. Change the test pattern using the **LEFT** and **RIGHT** arrow buttons. The following test patterns are available: *White, Black, Red, Green, Blue, Checkerboard, Crosshatch, V Burst, H Burst, Color Bar, Screen Layout, Off.*
- Alternatively, open the OSD by pressing **MENU**. Highlight **Test Patterns** from the main menu, then select a test pattern using the **LEFT** and **RIGHT** arrow buttons.

After the final test pattern, the projector exits test pattern mode and returns to the main image. To view test patterns again, you need to press **TEST** again. If you wish to exit the test patterns before you reach the final one, press **TEST** or **EXIT** at any time.

Notes



See *Connecting the power supply* on page 11.



The self-test is running when all the LEDs on the control panel are lit.



Use only the power cable provided.



Ensure that the power outlet includes a ground connection as this equipment **MUST** be earthed.



Handle the power cable carefully and avoid sharp bends. Do not use a damaged power cable.



See *Using the menus* on page 34 for full details of how to use the controls and the menu system.

Adjusting the lens

The lens can be adjusted using the Lens menu, or using the lens buttons on the remote control.

Lens menu

The **Lens** menu provides access to the **Lens Control** setting and the **Lens Center** command.

Lens Control allows **Zoom**, **Focus** and **Shift** adjustments using the arrow buttons. The setting operates in **Zoom/Focus Adjustment** and **Shift Adjustment** mode.

Press **ENTER/SELECT** to switch between the two modes.

Remote control

Use the remote control to adjust zoom, focus and shift directly, without opening a menu:

- **OK** enters lens control, then switches between Zoom/Focus Adjustment and Shift Adjustment.
- **EXIT** exits lens control and opens the Lens menu.
- **MENU** exits lens control and returns to the main image.
- The arrow buttons adjust zoom, focus and shift as indicated on the screen.

Adjusting the image

Orientation

This can be set from the **Setup** menu.

Highlight **Orientation** and choose from **Front Tabletop**, **Front Ceiling**, **Rear Tabletop**, **Rear Ceiling** and **Auto-front**.

Geometry

Settings such as **Keystone**, **Rotation**, **Pincushion / Barrel** and **Arc** can be set from the **Geometry** menu.

Picture

Settings such as **Gamma**, **Brightness**, **Contrast**, **Saturation**, **Hue** and **Sharpness** can be set from the **Image** menu.

Notes



See Remote control on page 15 for full details of how to adjust the lens using the remote control.



Neither of the settings under Picture are available with the HDMI 3 and 4 inputs.

This page is intentionally left blank

DIGITAL 
PROJECTION

A Delta Associate Company

E-Vision Laser 11000 4K-UHD Series

High Brightness Digital Video Projector

CONNECTION GUIDE



Signal inputs

Digital inputs and outputs

1. **HDBaseT**

Receives digital signal from HDBaseT-compliant devices. Connect an HDBaseT cable.

2. **3G-SDI in**

3. **3G-SDI out**

Connect a 3G-SDI cable to distribute the 3G-SDI signal to another projector.

4. **HDMI 1 / HDMI 2**

HDMI 2.0 inputs supporting HDCP 2.2. Connect an **HDMI** cable to the connector.

5. **HDMI 3 / HDMI 4**

HDMI 1.4b inputs supporting **Frame Sequential** and **Dual Pipe** 3D with HDCP 1.4. Also supports the domestic Blu-Ray formats. See supported signal input modes on page 109. Connect an **HDMI** cable to the connector.

6. **DisplayPort**

DisplayPort 1.2 input. Connect a DisplayPort cable to the connector. Supports sources up to 4K-UHD resolution at 60 Hz and WQXGA at 120Hz.

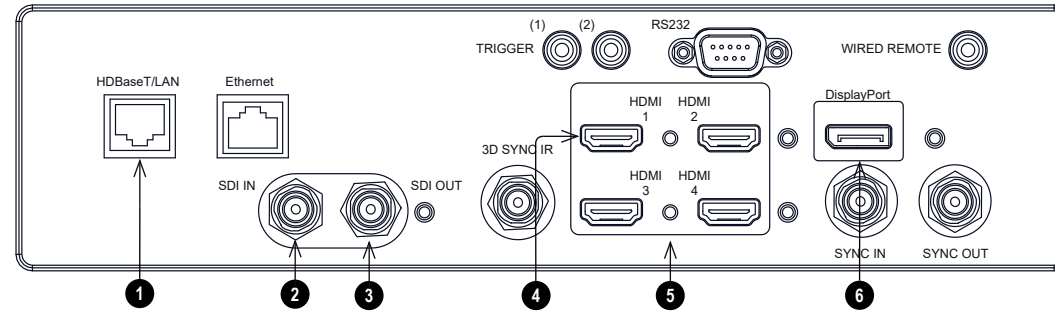

Notes



For simultaneous HDBaseT and LAN connectivity, a third-party distribution product can be utilised to combine HDBaseT video stream with LAN connection for delivery to the projector.

EDID on the DisplayPort, HDMI, and HDBaseT inputs

If you are using a computer graphics card or another source that obeys the EDID protocol, the source will automatically configure itself to suit the capability of the projector.

Otherwise refer to the documentation supplied with the source to manually set the resolution to the DMD™ resolution of the projector or the nearest suitable setting. Switch off the source, connect to the projector, then switch the source back on again.

Using DisplayPort/ HDMI/ HDBaseT switchers with the projector

When using a DisplayPort/HDMI/HDBaseT source switcher with the projector, it is important to set the switcher so that it passes the projector EDID through to the source devices.

If this is not done, the projector may not be able to lock to the source or display the source correctly as its video output timings may not be compatible with those of the projector. Sometimes this is called transparent, pass-through or clone mode. See your switcher's manual for information on how to set this mode.

1. Sources
2. Switcher
3. Projector

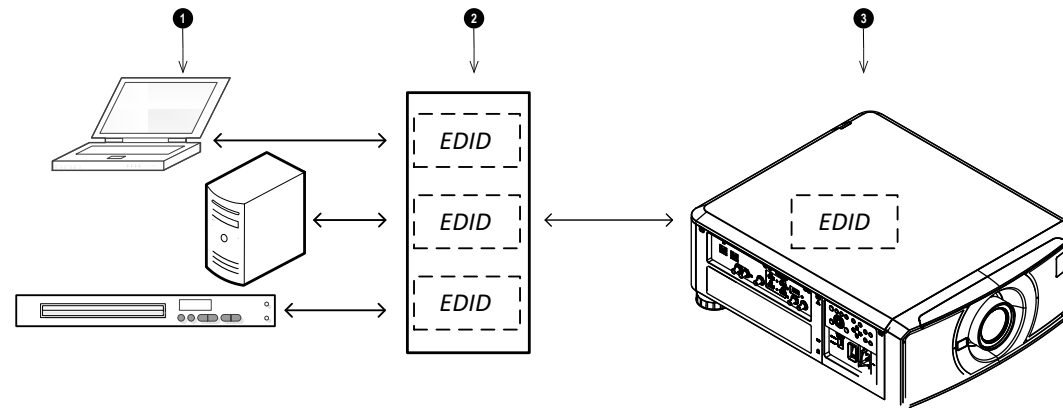

The EDIDs in the switcher should be the same as the one in the projector.

Notes

3D connections

1. 3D Sync IR

Sync output signal. This is affected by settings in the 3D menu such as Dark Time and 3D Sync Offset. Connect this to an IR emitter or ZScreen.

2. HDMI 3 / HDMI 4

HDMI 1.4b inputs supporting **Frame Sequential** and **Dual Pipe** 3D with HDCP 1.4. Also supports the domestic Blu-Ray formats. See supported signal input modes on page 109. Connect an **HDMI** cable to the connector.

3. Sync In / Sync Out

Sync In is the 3D sync input signal. Connect the 3D sync from your graphics card or server.

Sync Out is the 3D sync output signal. Enables 3D from multiple projectors.

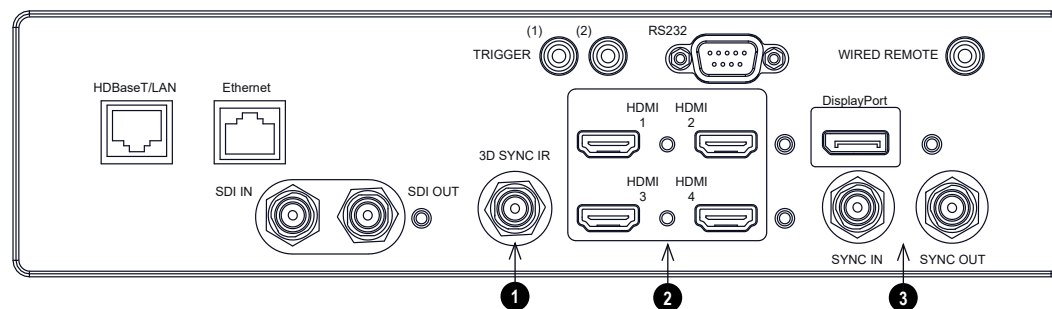

Frame sequential 1080p 3D up to 120Hz and WUXGA 3D at 100Hz

1. Connect to HDMI 3 or 4.
2. Set **3D Format** in the **3D** menu to **Frame Sequential**.

Dual Pipe 1080p, WUXGA and WQXGA+ 3D sources at up to 100 and 120Hz

1. Connect the left eye output to the **HDMI 3** socket and the right eye output to the **HDMI 4** socket.
2. Set **3D Format** in the **3D** menu to **Dual-Pipe**.

Notes

 See 3D formats on page 112 for a complete list of supported formats and frame rates.

3D Sync

- 1. 3D Input
- 2. 3D Sync In
- 3. 3D Sync IR
- 4. IR emitter or Zscreen

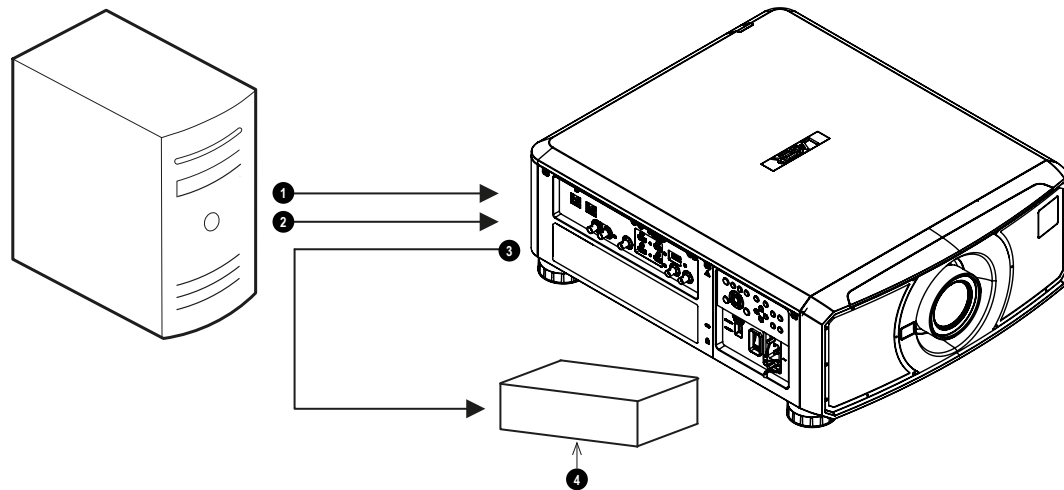

Notes

Control connections

1. HDBaseT/LAN

The projector's features can be controlled via a LAN connection, using Digital Projection's **Projector Controller** application or a terminal-emulation program.

2. Ethernet

This dedicated LAN connection can be used if **HDBaseT/LAN** is already being used for HDBaseT signal input.

3. Trigger 1 & Trigger 2

The Trigger outputs are defined in the **Setup** menu. Each output can be triggered by one of the following conditions:

- **Screen trigger.** A trigger output can be used to control an electrically operated screen. The screen will be automatically deployed when the projector starts up and retracted when the projector shuts down.
- **Aspect ratio trigger.** A trigger output can be used to control screen shuttering for different aspect ratios.
- **RS232 trigger.** A trigger output can be used to control the screen or screen shuttering on receipt of an RS232 command.

4. RS232

All of the projector's features can be controlled via a serial connection, using commands described in the **Protocol Guide**. Use a straight-through cable to connect directly to a computer.

5. Wired Remote

The remote control can be connected using a standard 3.5 mm mini jack cable (tip-ring-sleeve, or TRS).

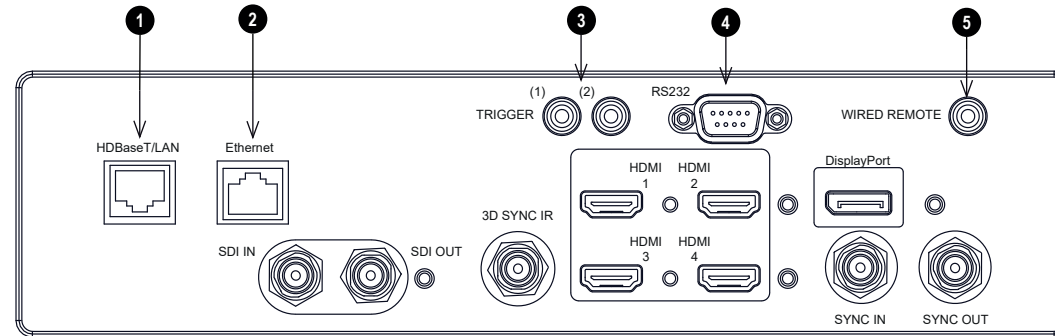

Notes

*For a list of all commands used to control the projector via LAN, see the **Protocol Guide** (available separately).*

Only one remote connection (RS232 or LAN) should be used at any one time.

With a LAN connection the projector can serve a web page offering status and projector controls.

Trigger 1 and Trigger 2 are not available with HDMI 3 and 4 inputs.

Projector Controller is available for download, free of charge, from the Digital Projection website.

LAN connection examples

The projector's features can be controlled via a LAN connection, using Digital Projection's **Projector Controller** application or a terminal emulation program.

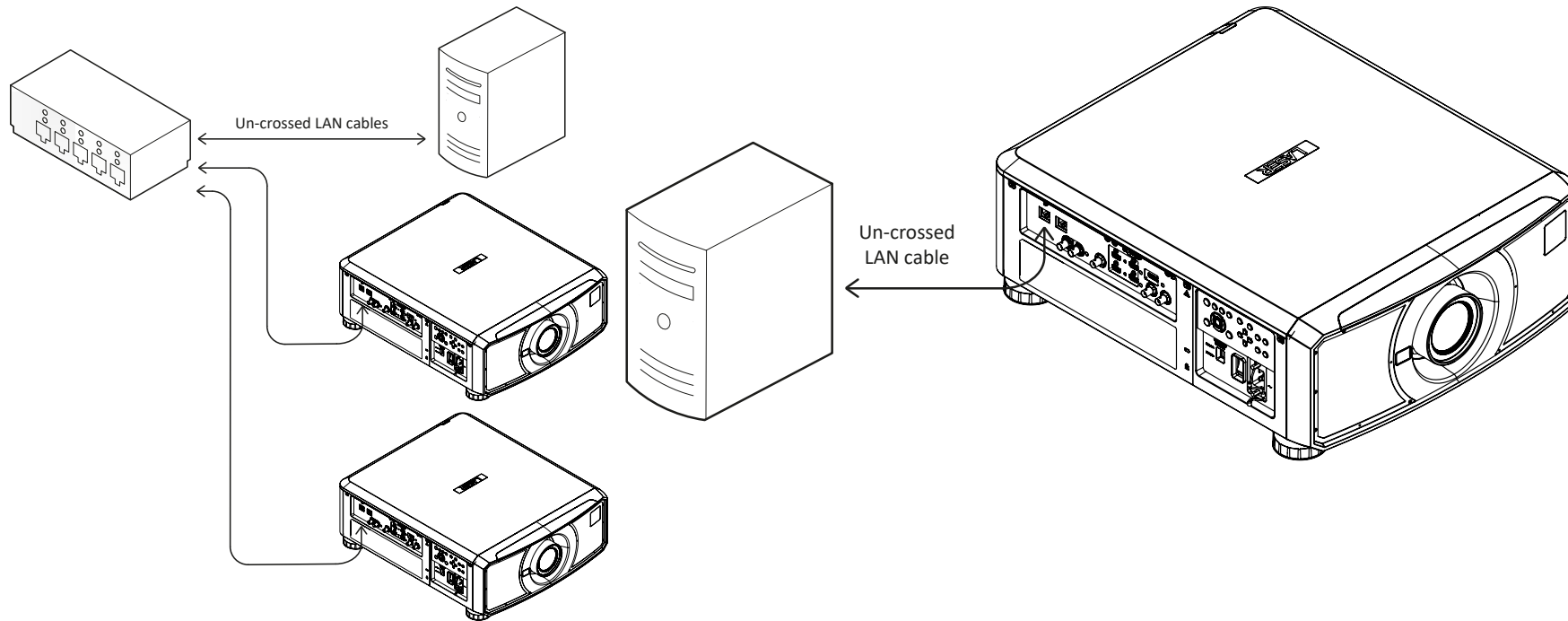

Notes

With a LAN connection the projector can serve a web page offering basic projector controls.

***Projector Controller** is available for download, free of charge, from the Digital Projection website.*

For simultaneous HDBaseT and LAN connectivity, a third-party distribution product can be utilised to combine HDBaseT video stream with LAN connection for delivery to the projector.

RS232 connection example

All of the projector's features can be controlled via a serial connection, using commands described in the **Protocol Guide**.

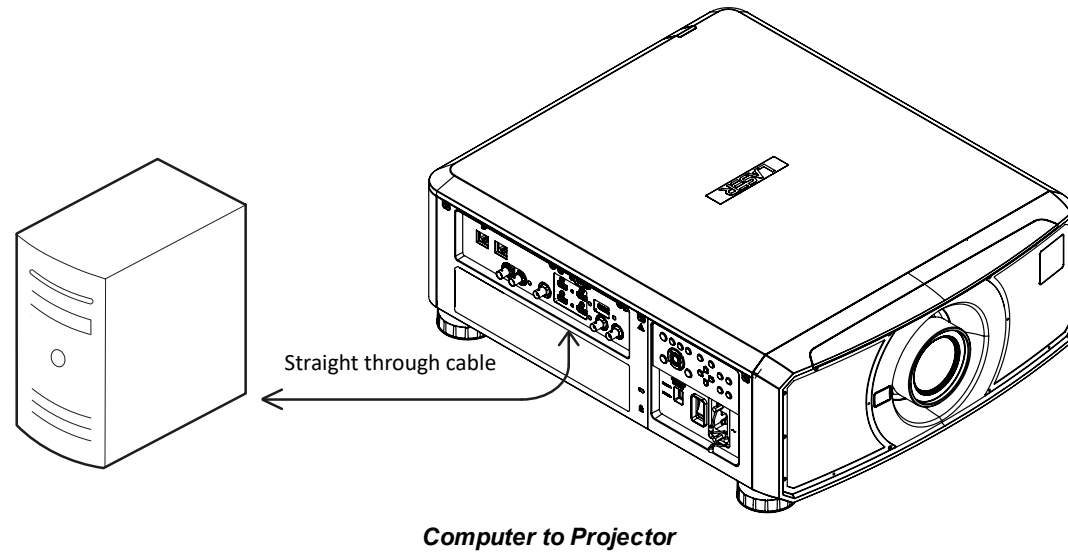

Notes

 The **Protocol Guide** is available separately

DIGITAL 
PROJECTION

A Delta Associate Company

E-Vision Laser 11000 4K-UHD Series

High Brightness Digital Video Projector

OPERATING GUIDE



Using the menus

Opening the Menu

Access the various menus using either the projector control panel or the remote control. On either device:

1. Press the **MENU** button.
The on-screen display (OSD) opens showing the list of available menus

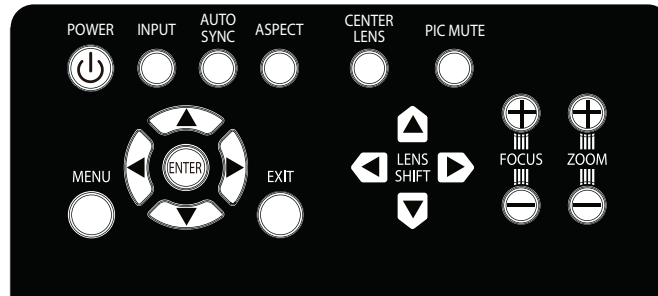

Projector control panel

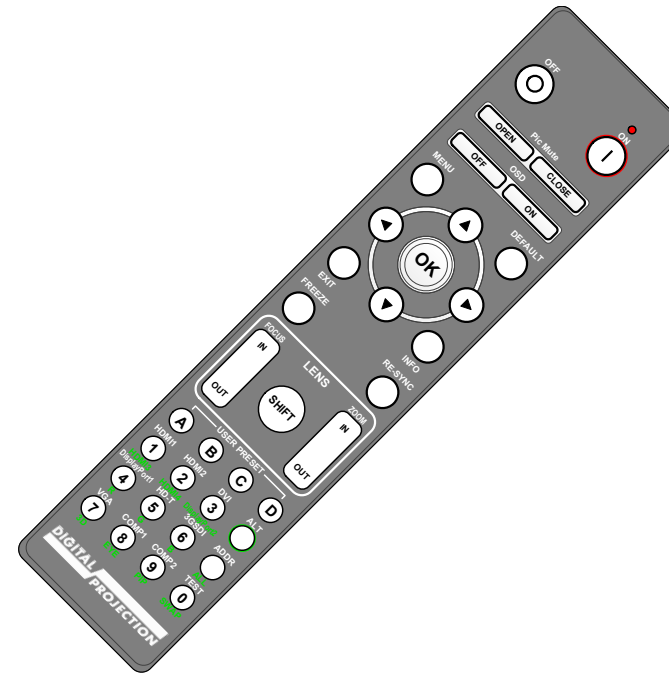

Remote control

Opening a submenu

Move up and down the list using the **UP** and **DOWN** arrow buttons.

To open a submenu:

1. Press **ENTER** on the control panel or **OK** on the remote control.

This guide refers to the above two buttons as **ENTER/OK**.

Notes

Exiting menus and closing the OSD

To go back to the previous page:

1. Press **EXIT**.

To close the OSD:

1. Press **MENU**.

Or:

1. Go back to the top level menu
2. Press **EXIT**.

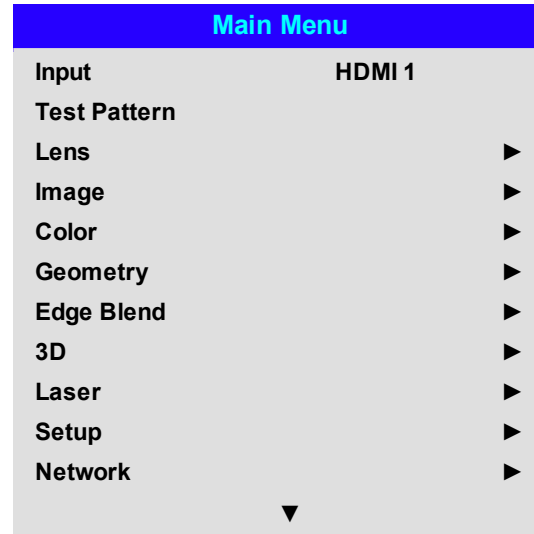

On Screen Display (OSD): Top Level Menu

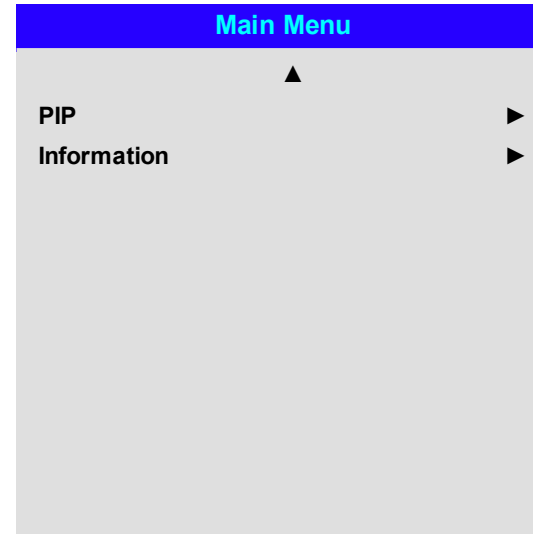

OSD: Top Level Menu Continued

Inside a menu

When you open a menu, the page consists of the following elements:

- Title bar at the top shows which menu you have accessed.
- Highlighted item
- Available and unavailable items Unavailable items appear a pale gray color. Whether an item is available may depend on other settings.
- The text or symbol to the right of an item shows whether the item:
 - has a value that can be changed (the current value is shown)
 - opens a sub-menu (an arrow button is displayed)
 - executes a command (the space to the right of the item is blank).

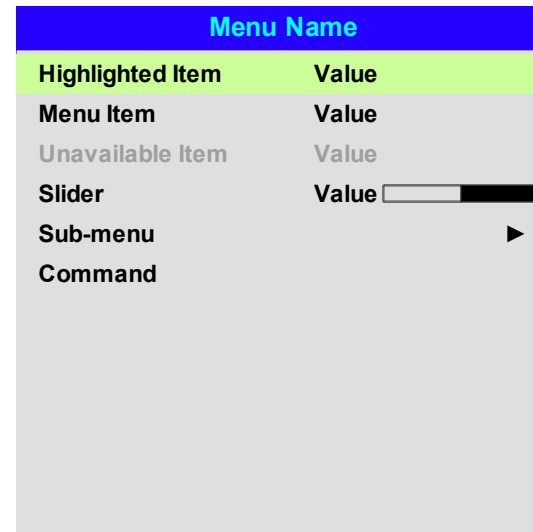

Inside a menu

 *The highlighted item has green background.*

Notes

Accessing sub menus

Use the **UP** and **DOWN** arrow buttons to highlight the sub-menu, then press **ENTER/OK**.

Executing commands

If the item contains a command, highlighting it reveals an **OK** button.

Press **ENTER/OK** to execute the highlighted command.

You may be asked for confirmation. Use the **ENTER/OK** to confirm, or **EXIT** to cancel.

Menu Name	
Menu Item	Value
Highlighted Command	OK

Highlighted Command

Command Name
Warning All [Menu] values will be lost.
Press OK to confirm Press Exit to cancel

Confirmation Dialog

Notes

Editing projector settings

If the highlighted menu item contains a list of values to choose from, you can change the value by doing the following:

1. Highlight the menu item and press **ENTER/OK**.
2. In the list of values that opens, use the **UP** and **DOWN** arrow buttons to highlight a value, then press **ENTER/OK** again to select the highlighted value.

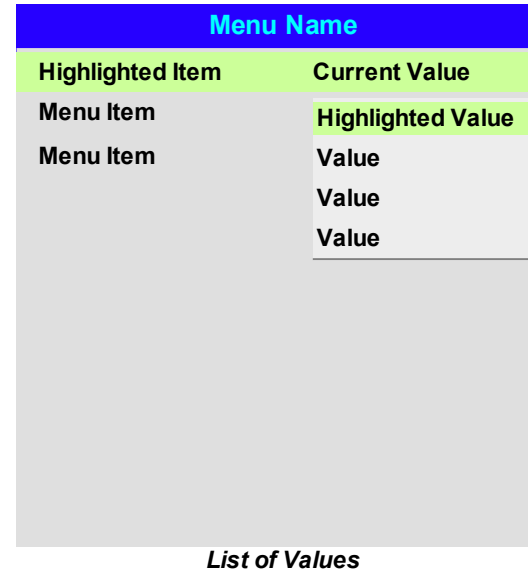

Notes

 Some menu items may be unavailable due to settings in other menus. Unavailable menu items appear gray

Using a slider to set a value

Some parameters open a slider. To set such a parameter:

1. Press the **LEFT** or **RIGHT** arrow button, or **ENTER/OK**. The arrow buttons will open the slider and adjust the value at the same time. **ENTER/OK** will open the slider without altering the initial value.
2. Use the **LEFT** and **RIGHT** arrow buttons to move the slider.
3. When ready, press **EXIT** to exit the slider and return to the menu, or press **MENU** to exit the slider without showing the menu again.

Editing numeric values

Some parameters take numeric values without using sliders - for example, color matching values or IP addresses.

1. Use the **UP** and **DOWN** arrow buttons to highlight the row containing the numeric field you wish to edit.
2. Press **ENTER/OK** to enter edit mode. A numeric field in edit mode is white text on blue background.
3. In edit mode:
 - Use the **UP** arrow button to increase the numeric value.
 - Use the **DOWN** arrow button to decrease the numeric value.
4. Use the **LEFT** and **RIGHT** arrow buttons to edit the next or previous numeric fields within the same row.
5. Once ready, press **ENTER/OK** to exit edit mode.

Data	
Row	x: 0.658 y: 0.339
Highlighted Row	x: 0.315 y: 0.662
Row	x: 0.146 y: 0.043
Row	x: 0.276 y: 0.283

Notes

Using the projector

Main menu

- **Input**
Press **ENTER/OK** to open the list of available inputs. Use the **UP** and **DOWN** arrow buttons to select an input from the list, then press **ENTER/OK** to confirm your choice. Press **EXIT** to return to the main menu.
- **Test Pattern**
Choose from: *White, Black, Red, Green, Blue, Checkerboard, Crosshatch, V Burst, H Burst, Color Bar, Screen Layout, Off*. Use the **LEFT** and **RIGHT** arrow buttons to switch between values.
- **Lens, Image, Color, Geometry, Edge Blend, 3D, Laser, Setup and Network.**
Press **ENTER/OK** to open these menus and access various settings.

Press the **DOWN** arrow at the bottom of the page to access additional menus:

- **PIP and Information**
Press **ENTER/OK** to open these menus and access various settings.

Press the **UP** arrow to return to the previous page.

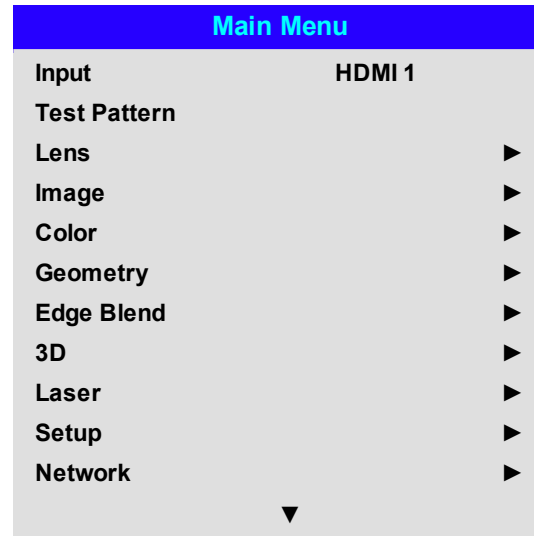

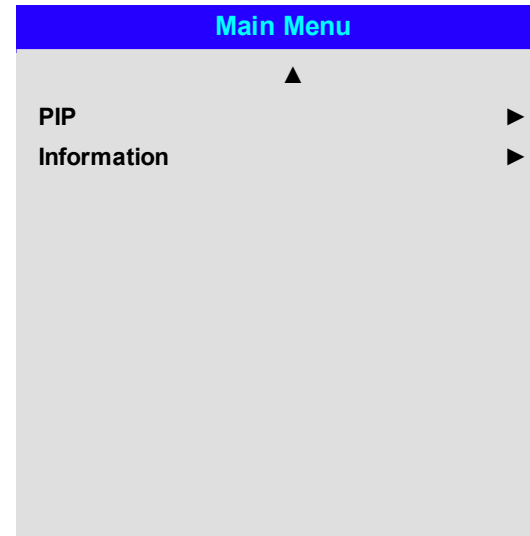

Main Menu, page 1



Main menu, page 2

Notes

 See Signal inputs on page 26 for information about the available inputs and connections.

 Selecting a test pattern hides the OSD. Press **EXIT** to hide the test pattern, and then press **MENU** to show the OSD

Lens menu

- **Lens Lock**
When this feature is **On**, all other Lens menu items are disabled.
- **Lens Control**
Opens a sub-menu, see below.
- **Center Lens**
Centers the lens.
- **Lens Type**
Choose a UST or a non-UST lens.
- **Lens Memory**
Opens a sub-menu, see next page.

Lens control

Lens Control settings operate in **Zoom/Focus Adjustment** and **Shift Adjustment** mode. Press **ENTER/OK** to switch between modes.

When in **Zoom/Focus Adjustment** mode:

- Use the **UP** and **DOWN** arrow buttons to adjust **Zoom**.
- Use the **LEFT** and **RIGHT** arrow buttons to adjust **Focus**.

When in **Shift Adjustment** mode, use the arrow buttons to adjust **Shift**.

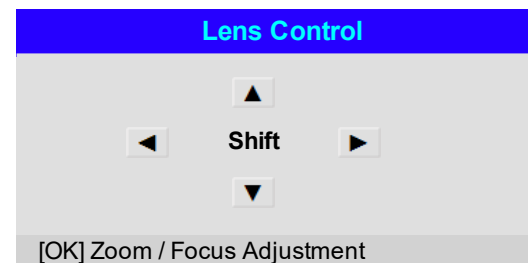
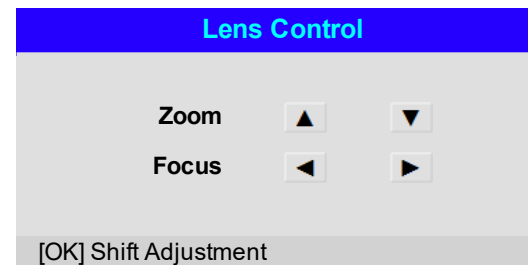
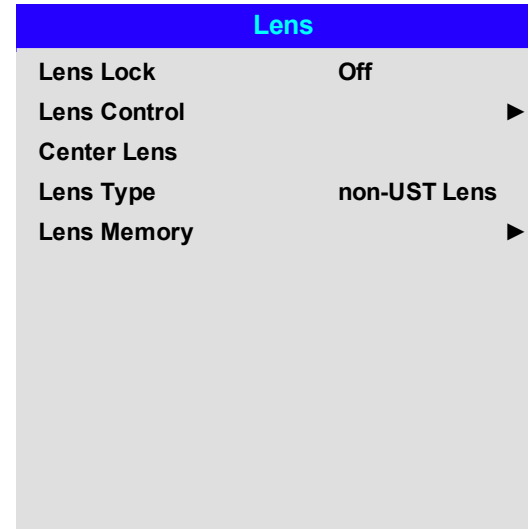

Notes

Lens memory

This menu allows you to load, save and delete up to ten lens presets, containing position, zoom, focus and shift adjustment information.

For example, if using different screen sizes and aspect ratios, you can save zoom, focus and positioning for each screen size and aspect ratio in a dedicated preset.

Use **Clear Memory** to delete a memory preset if you need to save a new combination of lens settings in its place. Overwriting a saved memory preset is not possible.

Lens Memory	
Load Memory	▶
Save Memory	▶
Clear Memory	▶

Notes

Lens Load Memory	
Memory 1	OK
Memory 2	
Memory 3	
Memory 4	
Memory 5	
Memory 6	
Memory 7	
Memory 8	
Memory 9	
Memory 10	

Lens Save Memory	
Memory 1	OK
Memory 2	
Memory 3	
Memory 4	
Memory 5	
Memory 6	
Memory 7	
Memory 8	
Memory 9	
Memory 10	

Lens Clear Memory	
Memory 1	OK
Memory 2	
Memory 3	
Memory 4	
Memory 5	
Memory 6	
Memory 7	
Memory 8	
Memory 9	
Memory 10	

Image menu

- **Picture Mode**

Choose from **High Bright**, **Presentation** and **Video**.

Use a different setting depending the type of input source.

Press **ENTER/SELECT** to open the list.

Use the **UP** and **DOWN** arrow buttons to select a picture mode from the list, then press **ENTER/OK** to confirm your choice.

Press **EXIT** to return to the main menu.

- **Dynamic Black**

Set to On to allow for increased contrast in darker scenes by modulating the light source.

- **Light Off Timer**

When **Dynamic Black** is **On**, the **Light Off Timer** will define if laser light source will turn off after a period of time has passed. The options are: **Disable**, **0.5**, **1.0**, **1.5**, **2.0**, **3.0**, **4.0** seconds.

- **Smooth Picture**

When this feature is **On**, the projector will resize the incoming signal to display in 4K-UHD resolution.

When **Off** sources will be displayed within WQXGA+ resolution.

Auto will display 4K-UHD sources in 4K-UHD resolution with Smooth Picture **On**.

Lower resolution sources will be displayed within WQXGA+ resolution with Smooth Picture **Off**.

Aspect ratio selection applies for both Smooth Picture **On** or **Off**.

- **Gamma**

Choose a de-gamma curve from **1.0**, **1.8**, **2.0**, **2.2**, **2.35**, **2.5**, **S-Curve**, and **DICOM**.

Used correctly, the **Gamma** setting can improve contrast while maintaining good details for blacks and whites.

If excess ambient light washes out the image and it is difficult to see details in dark areas, lower the

Gamma setting to compensate. This improves contrast while maintaining good details for blacks.

Conversely, if the image is washed out and unnatural, with excessive detail in black areas, increase the setting.

S-Curve is an enhanced mid-tone gamma.

DICOM is a simulated DICOM display, which can be used for training applications.

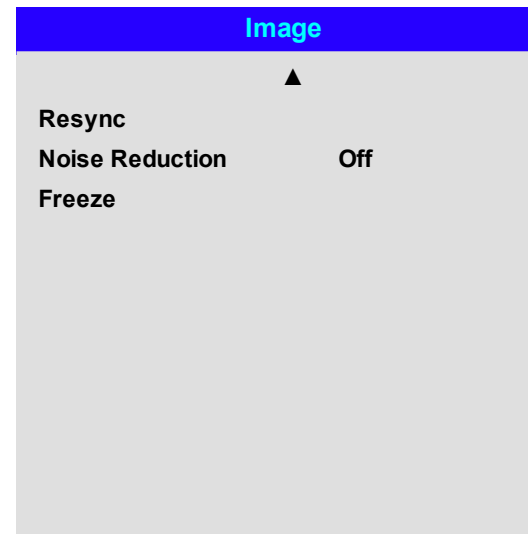
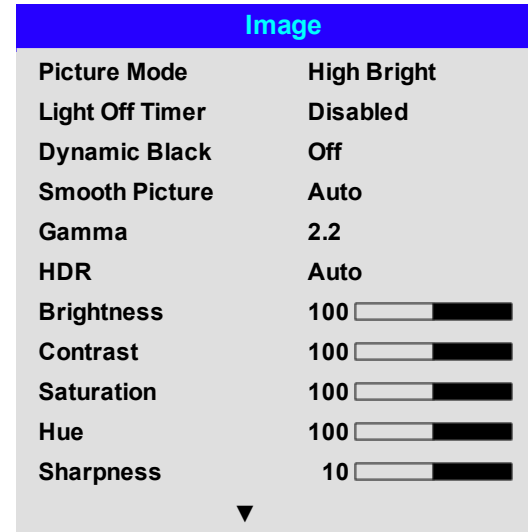

Notes

The following settings are not available with input HDMI 3 or HDMI 4:

Image > Dynamic Black, Smooth Picture, Brightness, Contrast, Saturation, Hue, Sharpness, Noise Reduction, Freeze, Resync.

Color > Color Space.

Geometry > Aspect Ratio, Digital Zoom, Overscan.

Setup > Screen Setting, Auto Source, Trigger-1, Trigger-2.

PIP > all settings.



- **HDR**

Choose from *AUTO*, *HDRPQ-400*, *HDRPQ500*, *HDRPQ1000* and *HDRHLG*.

HDR (High Dynamic Range) is a new form of gamma developed to create more realistic experience when viewing images delivered using this format, such as scenes with bright sunlight. Unlike traditional gamma HDR is not device or installation independent. HDR content will come with a recommended brightness regardless of screen size. For best results as a guideline the following screens sizes are suggested.

HDR Screen sizes		Screen width (cm)		
Model	Lumens	400 NIT	500 NIT	1000 NIT
EVL 11000 4K	9,500	366.60cm	327.90cm	231.90cm

HDR options should only be used with media players and sources equipped with HDR and HDR content.

Perceptual Quantizer (PQ) is the digitizing concept for capture and display and provides metadata to enable the display to understand the coding of the content.

The NIT numbers relate to the brightness of the viewing conditions in NIT. NIT is the unit of brightness measurement for monitors and LED walls that emit light rather than reflect it such as a projection screen. However it is a reference to the brightness you would choose for a given environment.

HDRHLG is High Dynamic Range – hybrid-log-gamma. This is a broadcast version of HDR for live TV and events.

- **Brightness, Contrast, Saturation, Hue, Sharpness**

Highlight the setting you wish to edit, and then press **ENTER/OK**, or the **LEFT** or **RIGHT** arrow button to open the slider.

Use the **LEFT** and **RIGHT** arrow buttons to adjust the slider.

Press **EXIT** to close the slider and return to the menu, or **MENU** to close the slider and return to the projected image.

- **Resync**

Press **ENTER/OK** to force the projector to resynchronise with the current input

- **Noise Reduction**

Choose a level of noise reduction from **Off**, **Low**, **Middle** and **High**.

- **Freeze**

Freezes the current frame.

Notes

Selecting a HDR setting will disable the Gamma setting.



If the HDR setting is Auto, the Gamma setting is only disabled when the image source is HDR



The HDR AUTO setting is only available when the incoming signal is HDR capable



Brightness, Contrast, Saturation, Hue, Sharpness and Noise Reduction are not available with the HDMI 3 and HDMI 4 inputs

Color menu

Color	
Color Space	Auto
Color Mode	ColorMax
ColorMax	Peak
Manual Color Matching	▶
Color Temperature	Native
Gains and Lifts	▶

Color space

In most cases, the Auto setting determines the correct colorspace to use. If it does not, you can choose a specific colorspace:

Choose from **Auto**, **YPbPr**, **YCbCr**, **RGB PC** and **RGB Video**.

Color	
Color Space	Auto
Color Mode	Auto
ColorMax	YPbPr
Manual Color Matching	YCbCr
Color Temperature	RGB PC
Gains and Lifts	RGB Video

Notes

 **Color Space** is not available with HDMI 3 or HDMI 4.

Color mode

The projector can work in the following color modes: **ColorMax**, **Manual Color Matching**, **Color Temperature** and **Gains and Lifts**.

Color	
Color Space	Auto
Color Mode	ColorMax
ColorMax	ColorMax
Manual Color Matching	Manual Color Matching
Color Temperature	Color Temperature
Gains and Lifts	Gains and Lifts

Notes

 Only one color mode can be selected at a time. Settings used by the other color modes are disabled.

ColorMax

1. Set **Color Mode** to **ColorMax**.
2. Navigate to the **ColorMax** setting.
3. Choose from **HDTV**, **Peak**, **User 1** and **User 2**. **User 1** and **User 2** are user-defined color gamuts set via the **Setup > ColorMax** menu.

Color	
Color Space	Auto
Color Mode	ColorMax
ColorMax	Peak
Manual Color Matching	HDTV
Color Temperature	Peak
Gains and Lifts	User 1
	User 2

 See Setup menu on page 72 for further information about setting up the **User 1** and **User 2** color gamuts.

Manual color matching

1. Set **Color Mode** to **Manual Color Matching**.
2. Open the **Manual Color Matching** submenu.

Here you can do the following:

- Switch **Auto Test Pattern On** and **Off**.
- Adjust **Hue, Saturation and Gain** settings for each individual color to improve the color balance of the projected image.
- Adjust white balance RGB values.
- Reset all values.

Manual Color Matching

Auto Test Pattern	Off	▶
Red		▶
Green		▶
Blue		▶
Yellow		▶
Cyan		▶
Magenta		▶
White Balance		▶
Reset		

Manual Color Matching - Red

Hue	100	<input type="range" value="100"/>
Saturation	100	<input type="range" value="100"/>
Gain	100	<input type="range" value="100"/>

Manual Color Matching - White Balance

Red	100	<input type="range" value="100"/>
Green	100	<input type="range" value="100"/>
Blue	100	<input type="range" value="100"/>

Notes

See Color matching parameters explained on the facing page for more details about the Hue, Saturation and Gain settings.



Color matching parameters explained

The levels of hue, saturation and gain in the Manual Color Matching menu change the color values in the following ways:

1. **Hue** Specifies the position of each color (red, yellow, green, cyan, blue and magenta) relative to its neighboring colors.
2. **Saturation** Specifies the level of white in each color (i.e. how “pale” each color is).
3. **Gain** Controls the amount of light that goes into each color, i.e. the lowest gain would produce black.

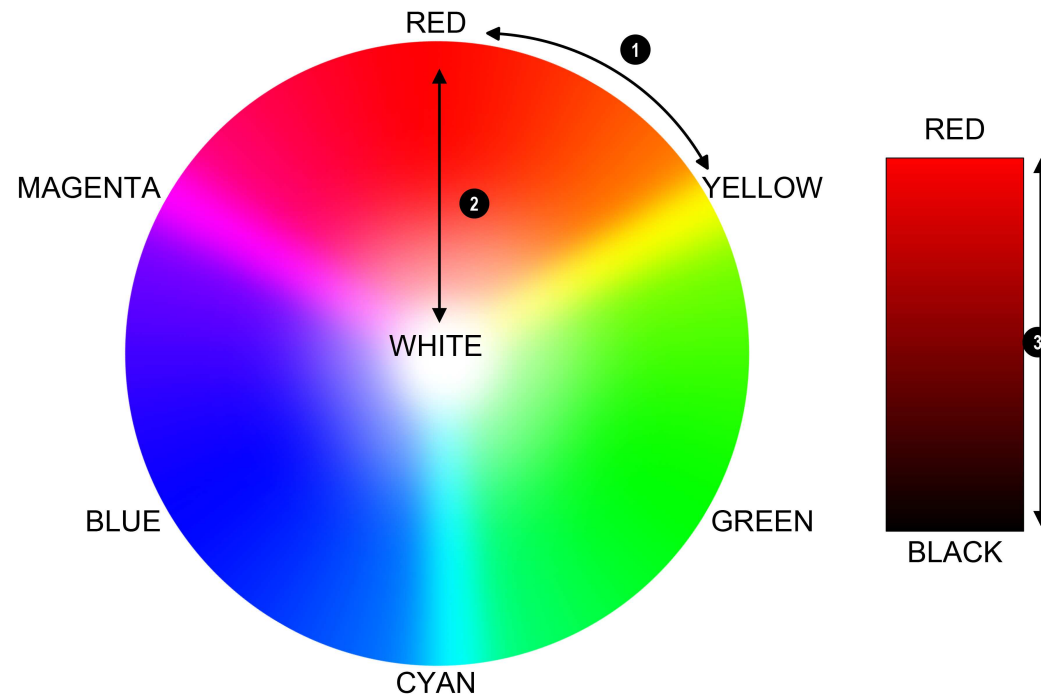

Notes

Color temperature

1. Set **Color Mode** to **Color Temperature**.
2. Navigate to the **Color Temperature** setting. Choose a value from **3200K** (warmer) to **9300K** (cooler) or **Native** (no correction).

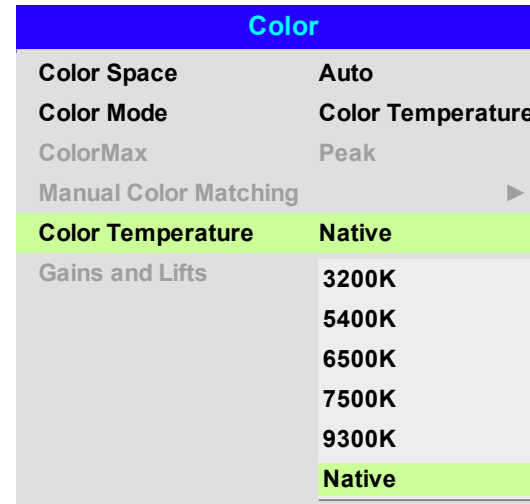

Gains and lifts

1. Set **Color Mode** to **Gains and Lifts**.
2. Open the **Gains and Lifts** submenu.

Lifts allow you to adjust black levels of individual colors, while gains adjust the bright part of the scale.

Set the sliders as required



Notes

Geometry menu

This menu allows you to compensate for image distortions caused by an unusual projection angle or irregular screen surface.

Geometry	
Aspect Ratio	Source
Digital Zoom	▶
Overscan	Off
Blanking	▶
Keystone	▶
4 Corners	▶
Rotation	▶
Pincushion / Barrel	▶
Arc	▶
Custom Warp	▶

Notes

 **Aspect Ratio, Digital Zoom and Overscan** are not available with input HDMI 3 or HDMI 4.

Only one of the following should be used at any one time: **Keystone, 4**

 **Corners, Rotation, Pincushion/Barrel and Arc.** For more complex adjustments use **Custom Warp** later in this section

Aspect ratio

This feature defines the aspect ratio of the source. Use the **Setup > Screen Setting** to define the screen aspect ratio.

If you choose a preset aspect ratio from here, it will give you the best fit for your selection.

Choose from:

- 5:4
- 4:3
- 16:10
- 16:9
- 1.88
- 2.35
- TheaterScope
- Source
- Unscaled

 Image scaling and aspect ratio are also influenced by **Setup > Screen Setting**.

 See **Theaterscope** setting on the next page for further information about the **TheaterScope** aspect ratio.

Theaterscope setting

The **TheaterScope** setting is used in combination with an anamorphic lens to restore 2.35:1 images packed into a 16:9 frame. Such images are projected with black lines at the top and bottom of the 16:9 screen to make up for the difference in aspect ratios.

Without an anamorphic lens and without the TheaterScope setting applied, a 16:9 source containing a 2.35:1 image looks like this:

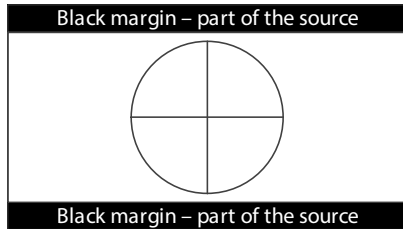

If we change the setting to TheaterScope, the black lines will disappear but the image will stretch vertically to reach the top and bottom of the DMD™:

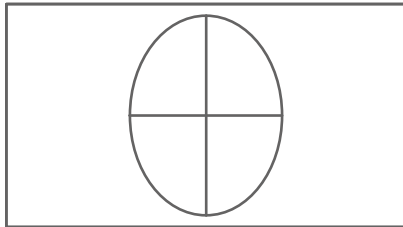

An anamorphic lens will stretch the image horizontally, restoring the original 2.35 ratio:

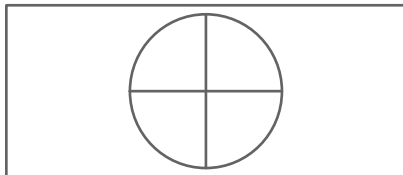

Notes

 TheaterScope is used with an anamorphic lens.

 If you use TheaterScope, set your screen aspect ratio to 16:9.

Digital zoom

Digital zooming enlarges a section of the image, while the area outside the enlarged section is cropped out to preserve the overall image size.

- **Digital Zoom** defines the level of zoom that needs to be applied. If **Digital Zoom** is set to 0, then the other settings in the menu will be disabled.
- **Digital Pan** and **Digital Scan** specify the area that is being enlarged:
 - **Digital Pan** adjusts the horizontal coordinates.
 - **Digital Scan** adjusts the vertical coordinates.

The **Reset** command restores the default **Digital Zoom**, **Digital Pan** and **Digital Scan** values.

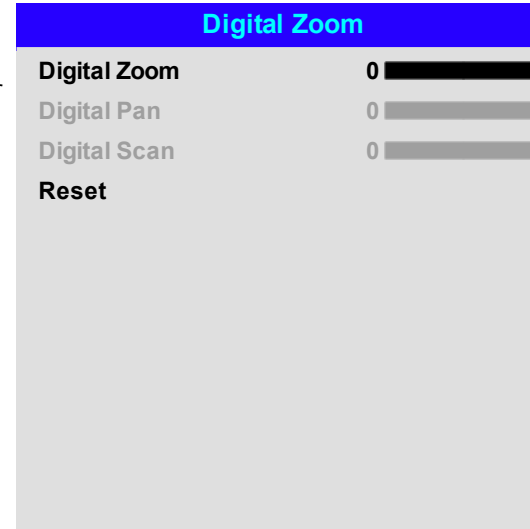

Notes

 **Digital Zoom** is not available with input HDMI 3 or HDMI 4.

 **Digital Zoom** is a temporary setting and not retained after an input change or power cycle.

Overscan

Use this setting to compensate for noisy or badly defined image edges.

Crop removes unwanted artifacts from the edges of your image by cropping the edges.

Zoom increases the size of the image to force the edges off-screen

Geometry	
Aspect Ratio	Source
Digital Zoom	▶
Overscan	Off
Blanking	Off
Keystone	Crop
4 Corners	Zoom
Rotation	
Pincushion / Barrel	▶
Arc	▶

Notes
 **Overscan** is not available with input HDMI 3 or HDMI 4.

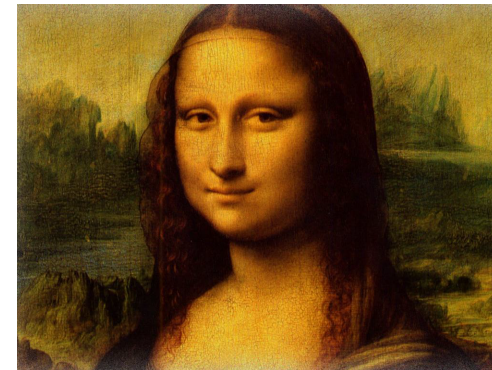
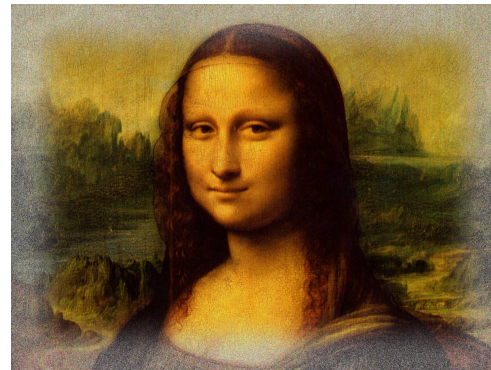

Blanking

Use this feature to:

- fit an odd-sized screen;
- cut off timecode dots in the top line of a picture;
- cut off subtitles, etc.

Select the edge you wish to blank and use the **LEFT** and **RIGHT** arrow buttons to determine the amount of correction.

Use the **Reset** command to restore blanked edges.

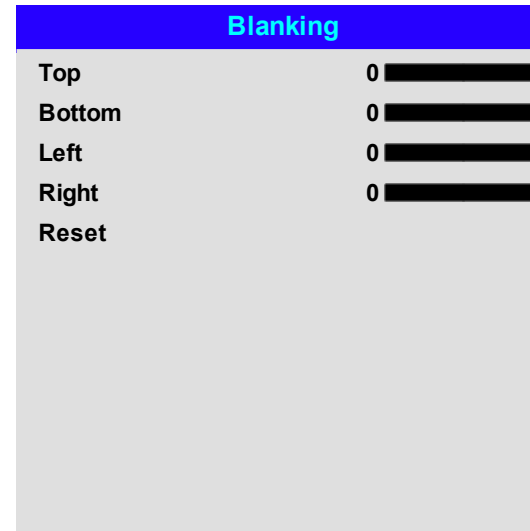

Notes

Keystone

Use this setting to compensate for any distortion caused by the projector being in a different horizontal or vertical plane to the screen.

Keystone

H Keystone	0	<input type="range"/>
V Keystone	0	<input type="range"/>
Rotation	0	<input type="range"/>
Reset		

Notes



Max rotation in Keystone is reduced from normal rotation

Keystone example

The projector is positioned at an angle

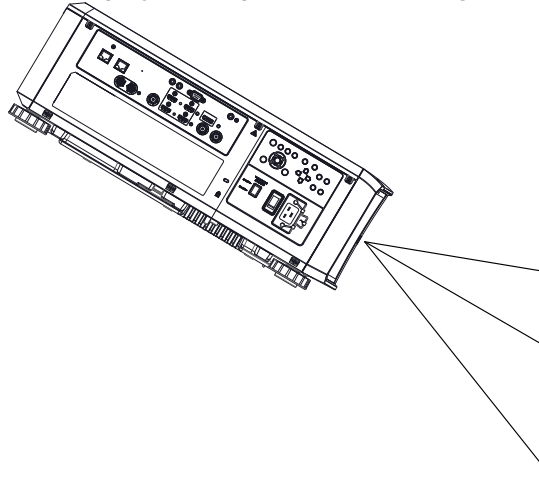

The resulting image is distorted

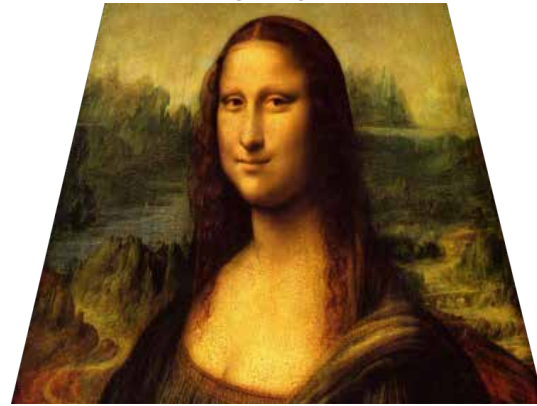

The image is corrected when Keystone is applied



Notes

Keystone settings

1. **Projector to the left** The projector is positioned to the left of the screen. To correct, apply a positive **Horizontal Keystone** value using the **RIGHT** arrow button.
2. **Projector to the right** The projector is positioned to the right of the screen. To correct, apply a negative **Horizontal Keystone** value using the **LEFT** arrow button.
3. **Projector high** The projector is positioned above the screen at a downward angle. To correct, apply a negative **Vertical Keystone** value using the **DOWN** arrow button.
4. **Projector low** The projector is positioned below the screen at an upward angle. To correct, apply a positive **Vertical Keystone** value using the **UP** arrow button.
5. **Projector straight** The projector is directly opposite the screen at a right angle both horizontally and vertically. No correction is needed.

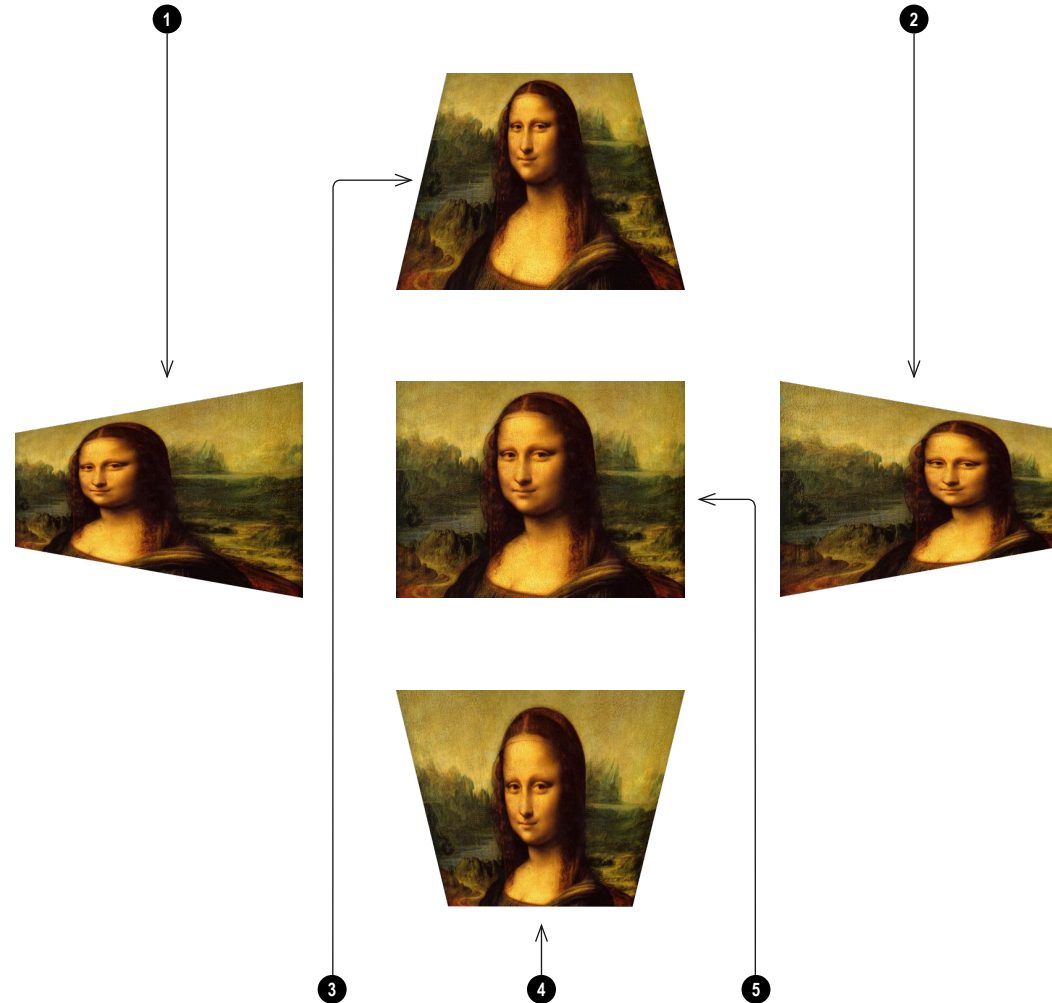
**Horizontal and vertical keystone corrections****Notes**

4 corners

For each corner, apply horizontal and / or vertical correction as necessary to restore the rectangular shape of the image.

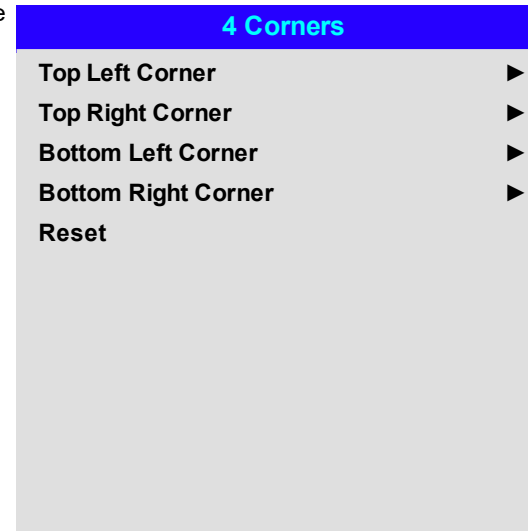

Notes

*Corner corrections provide a simple setup for awkward installations and irregular shaped screens that may distort the image. To apply a similar (but less flexible) correction, while preserving the original aspect ratio of the image, use the **Keystone** menu.*

Top right corner example

In this illustration, the top right corner requires both horizontal and vertical correction.

Top Right Corner Adjustment

Top Right Corner x ◀ 0 ▶

Top Right Corner y ▲ 0 ▼

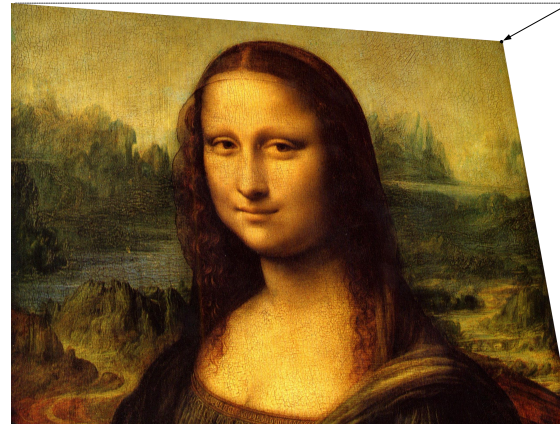

Notes

Rotation

Use this feature for example to correct a mounting error causing the image not to be level with the screen.

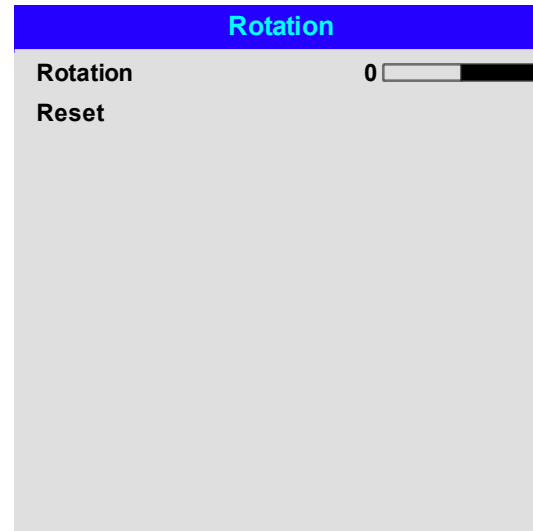

Notes

Rotation example

- 1. DMD™ area**
The DMD™ is not rotated. It still covers the area that would be occupied by the image without correction.
- 2. Rotated image**
The image is smaller than the surrounding DMD™ area. It is scaled in order to remain within the DMD™ area.
- 3. Angle of rotation**
Each step on the slider is 0.25° of rotation. In this example the angle is 5° , therefore Rotation value is 20.

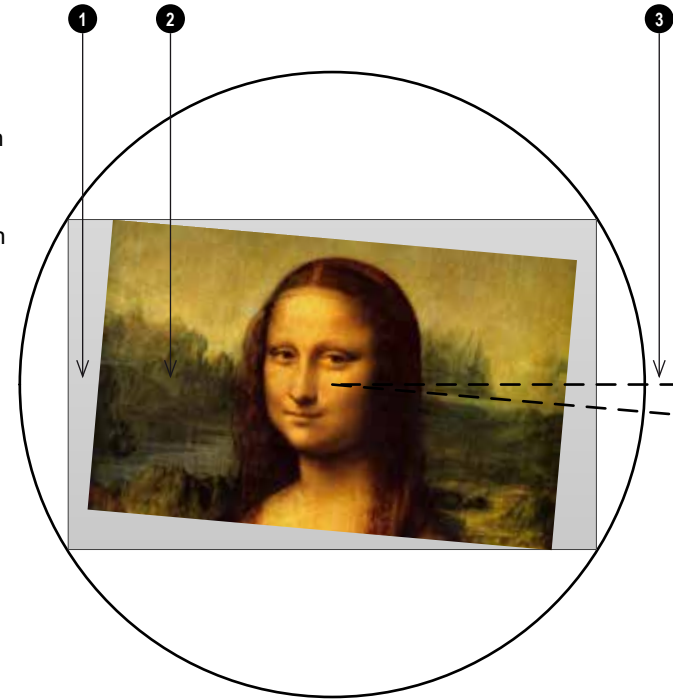
**Notes**

Pincushion / barrel

Pincushion or barrel distortions are the result of poor or incorrect tensioning of the screen or using a surface that is not flat.

Use the **Pincushion / Barrel** control to compensate electronically for such distortions.

You can also use this menu to make simple panoramic screen corrections without using external processors.

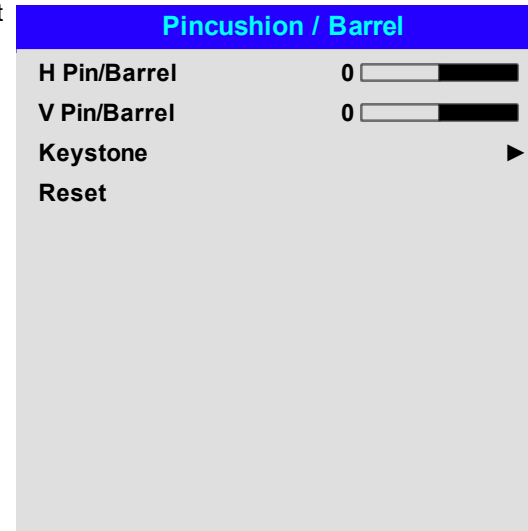

Notes

Pincushion/ Barrel example

The illustration shows pincushion and barrel correction applied both horizontally and vertically, in equal measures.

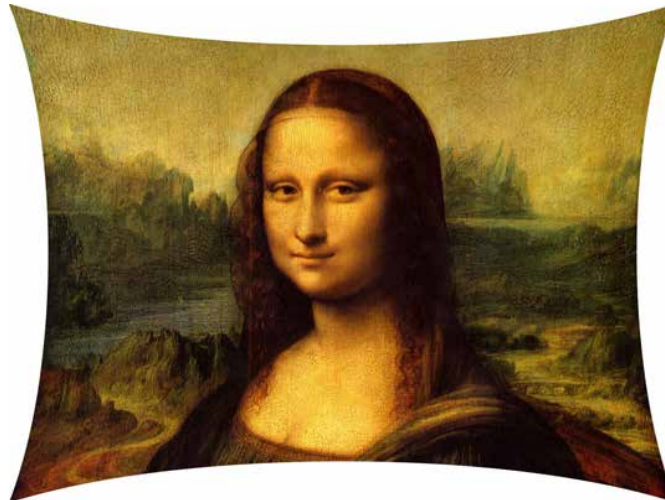

Pincushion



Barrel

Arc

This feature is similar to **Pincushion / Barrel** but allows you to apply curvature to each edge of the image independently so you can have any combination of corrections.

Arc	
Top	0 <input type="range"/>
Bottom	0 <input type="range"/>
Left	0 <input type="range"/>
Right	0 <input type="range"/>
Reset	



Notes

Please note that a positive **Arc** value on any edge will reduce the image size as the projector needs to maintain the aspect ratio. A negative **Arc** value will not affect the overall image size.



Custom warp

This feature permits selection of predefined User warp maps. Use the Projector Controller PC application to create the custom warp maps.

Custom warp maps provide non-linear curvature correction for curved or spherical screens and other irregular shaped surfaces such as building mapping.

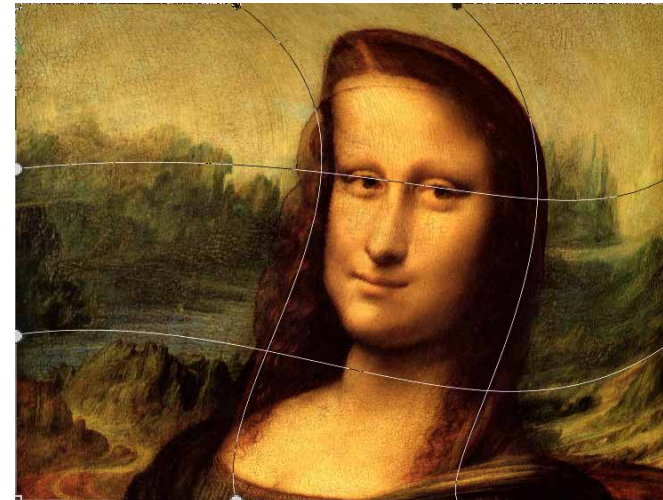
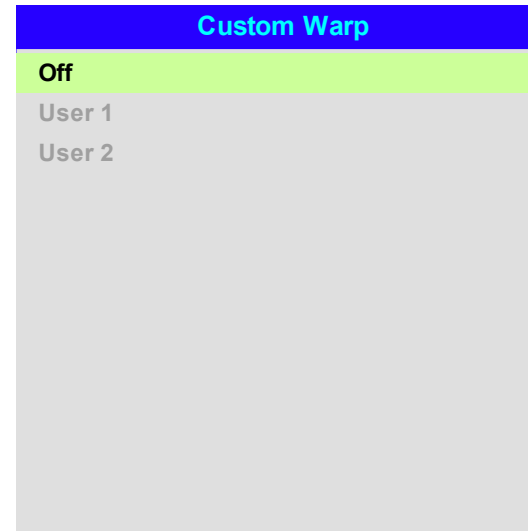

Notes

Edge blend menu

Use this menu to blend together images from an array of two or more projectors. The feature feathers the light output of the projector within the edges that overlap with other projectors in the array: as a result, the overlapping edges are evenly lit and easily blend in with the rest of the image.

- **Edge Blend**
Enable and disable **Edge Blend**
- **Align Pattern**
Add markers to the image showing the edges of the blend area and making the overlaps more visible to help adjust the physical position of the projectors in the array.
- **Blend Width**
Determine the width of the blended regions.
- **Black Level Uplift**
Adjust black levels to compensate if the blended regions appear brighter than the rest of the image.
- **Reset**
Reset all **Edge Blend** settings to their factory default values.

Edge Blend	
Edge Blend	On
Align Pattern	Off
Blend Width	▶
Black Level Uplift	▶
Reset	

Notes

 When **Edge Blend** is set to **Off**, all other edge blend settings are disabled.

 The picture in the blend region needs to be delivered to all overlapping projectors, which may require a special setup of the source.

Blend width

Use the **LEFT** and **RIGHT** arrow buttons to set the width of the blended regions:

1. Top
2. Bottom
3. Left
4. Right

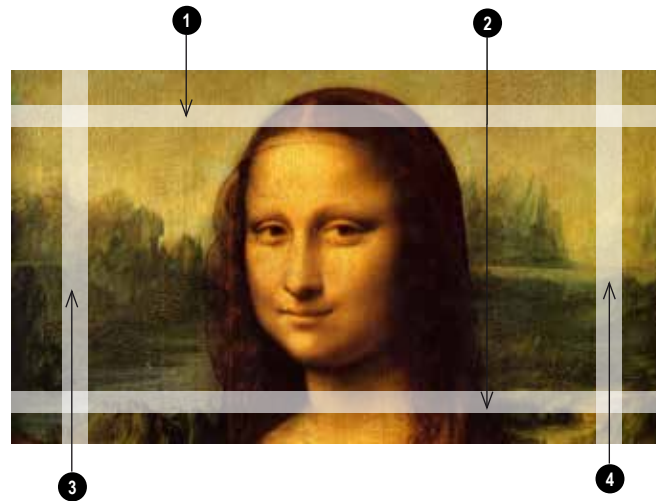

Notes

Black level uplift

Black in the blended regions appears less dark than in the rest of the image. To compensate for this, use this menu to raise the black levels of the rest of the image:

- Set **All** to the required amount of black level correction. This will apply equal correction to the black levels of all colors
- If necessary, use the individual color sliders (**Red**, **Green** and **Blue**) for fine adjustment.

You may experience artifacts at the edges where the blended region of one projector overlaps the *pond of mirrors* of its neighbor. In the example below, the blended image comes from *two projectors*, ① and ②. Both images have black level uplift applied; as a result, *artifacts* ③ and ④ have emerged at the edges where the black level uplift region of one projector overlaps the pond of mirrors of the other.

To remove the artifacts, you need to slightly reduce the size of the black level uplift region of each projector so it does not overlap the pond of mirrors of the other projector.

- Depending on your array, use **Top**, **Bottom**, **Left** and/or **Right** to reduce the black level uplift size. In the example below, use the **Right** slider of the **projector on the left** ① to remove the *artifact on the right* ④, and the **Left** slider of the **projector on the right** ② to remove the *artifact on the left* ③.

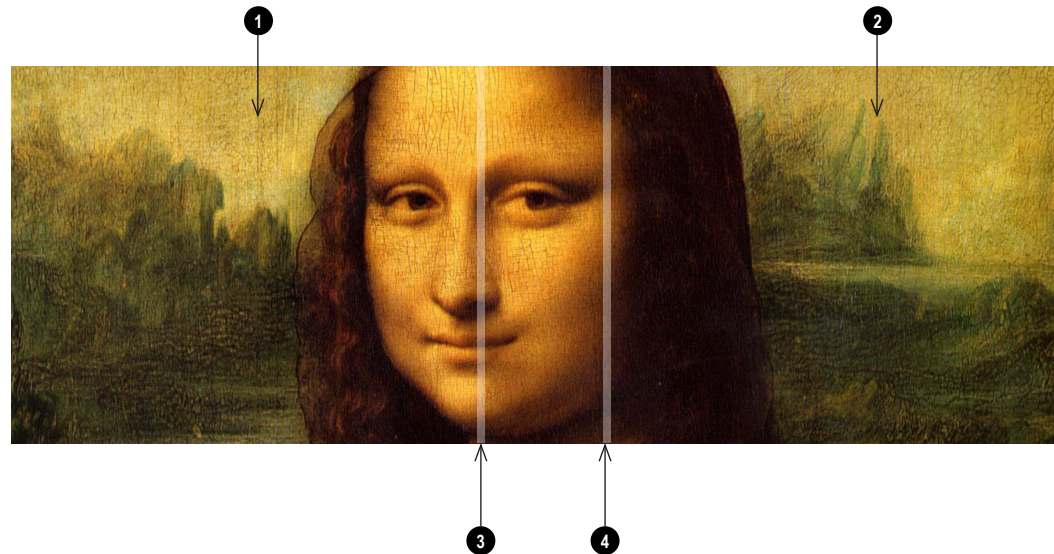

Black Level Uplift

Select Area

Top	0	<input type="range"/>
Bottom	0	<input type="range"/>
Left	0	<input type="range"/>
Right	0	<input type="range"/>

Color Adjustment

All	<input type="range"/>
Red	0 <input type="range"/>
Green	0 <input type="range"/>
Blue	0 <input type="range"/>

Notes



Enable **Align Pattern** from the **Edge Blend** menu to see the black level uplift area.

3D menu

Use this menu to enable, disable and set up 3D input, as follows:

- **3D Format — Off, Dual Pipe and Frame Sequential.**
Frame Sequential is for sources where Left and Right eye images are delivered as alternate frames from a single input. **Dual Pipe** is for sources where Left and Right eye are delivered on separate inputs.
- **DLP Link — Off / On.**
DLP Link On emits a sync pulse for the 3D glasses via the projected image. **DLP Link Off** will send the sync pulse to the sync out connector to use with an external third party emitter.
- **Eye Swap — Normal and Reverse.**
 (set to **Reverse** if the left- and right-eye images are displayed in the wrong order)
- **Dark Time — 0.65 ms, 1.3 ms and 1.95 ms.**
 Set to reduce the effect of banding and image overlapping when viewed through 3D glasses.
- **Sync Offset.**
 Use the **LEFT** and **RIGHT** arrow buttons to compensate for image overlapping (ghosting) when viewed through 3D glasses.
- **Sync Reference— External and Internal.**
 Select the source of the 3D sync. Internal is referenced to the incoming video. External is for Frame Sequential 3D sources and is supplied by the graphics card or player.

3D	
3D Format	Auto
DLP Link	Off
Eye Swap	Normal
Dark Time	1.95 ms
Sync Offset	100 
Sync Reference	Internal

Notes

 3D video is only possible on the HDMI 3 and HDMI 4 inputs.

 If **3D Format** is set to **Off**, all other 3D settings will be unavailable.

 See 3D connections on page 28 for more information about supported 3D formats.

The following settings are not available when 3D is on:

 **Image** > Smooth Picture, Brightness, Contrast, Saturation, Hue, Sharpness, Noise Reduction, Freeze, Resync.

Color > Color Space.

Geometry > Aspect Ratio, Digital Zoom, Overscan.

Setup > Screen Setting, Auto Source, Trigger-1, Trigger-2.

PIP > all settings.

 Also: See 3D types on the next page and See Some 3D settings explained on page 69

 See 3D formats on page 112 for 3D resolutions and frame rates.

3D types

To display a 3D image if is first necessary to select the 3D format. This can either be Frame Sequential or Dual Pipe. These formats are described below:

- **Dual Pipe (LEFT and RIGHT)** The left and right eye images are delivered on two separate HDMI links, which the projector will interleave for 3D display.
- **Frame Sequential** For sequential 3D, an external sync is required to identify left and right frames. If no sync is available from the sequential source, the projector will generate an output sync, but it may then be necessary to manually set the Eye Swap each time the player is started.

Dark Time and **Sync Offset** need to be set only once, to optimize the image for the glasses in use.

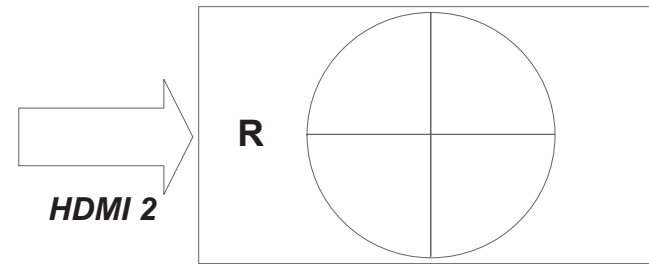
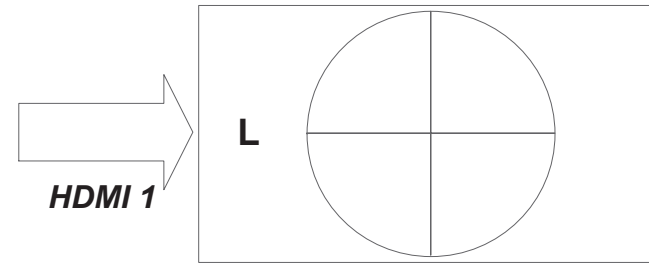

Dual Pipe

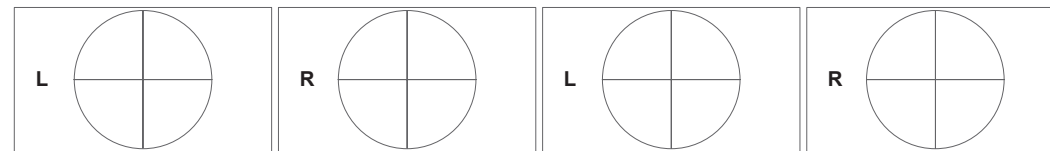

Sequential

Notes

Some 3D settings explained

Dark time

Banding can be caused if the image is displayed before each eye of the 3D switching glasses or ZScreen is not fully open. **Dark Time** allows you to minimize this effect.

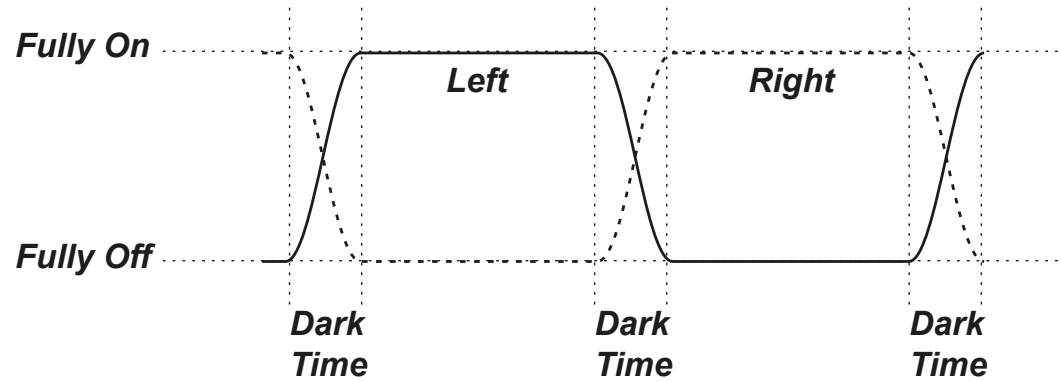

Notes

In order to achieve maximum light output and a smooth grayscale, whilst eliminating ghosting, the following procedure is recommended:

- 1.** Set **Dark Time** to a value appropriate to the glasses or ZScreen, say 1.3 ms or 1.95 ms.
- 2.** Adjust **Sync Offset** time to eliminate ghosting and achieve a smooth grayscale.
- 3.** Repeat steps 1 and 2 until the best result is obtained.



Eye swap

The outgoing 3D frames are in pairs - the dominant frame being presented first. You can determine which frame should be the dominant one.

By convention the default setting is **Left**.

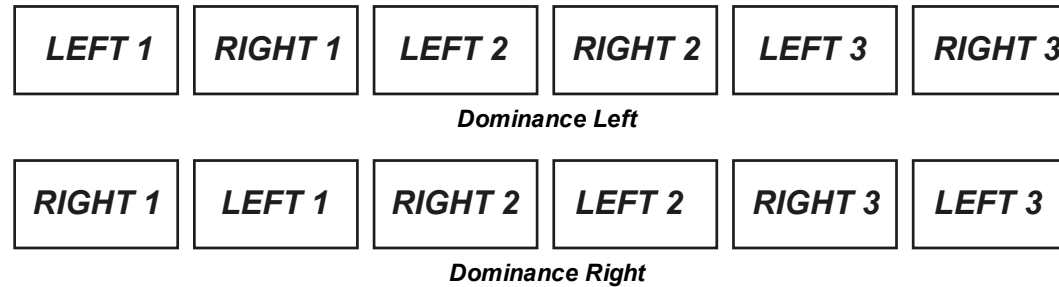

Sync offset

The sync signal from the 3D server will be in phase with the frames generated by its graphics card. However, to compensate for switching delays in the glasses or ZScreen, **Sync Offset** is used to adjust the sync output signal sent to the ZScreen or 3D glasses to minimise overlapping (ghosting in the image when viewed through the 3D glasses).

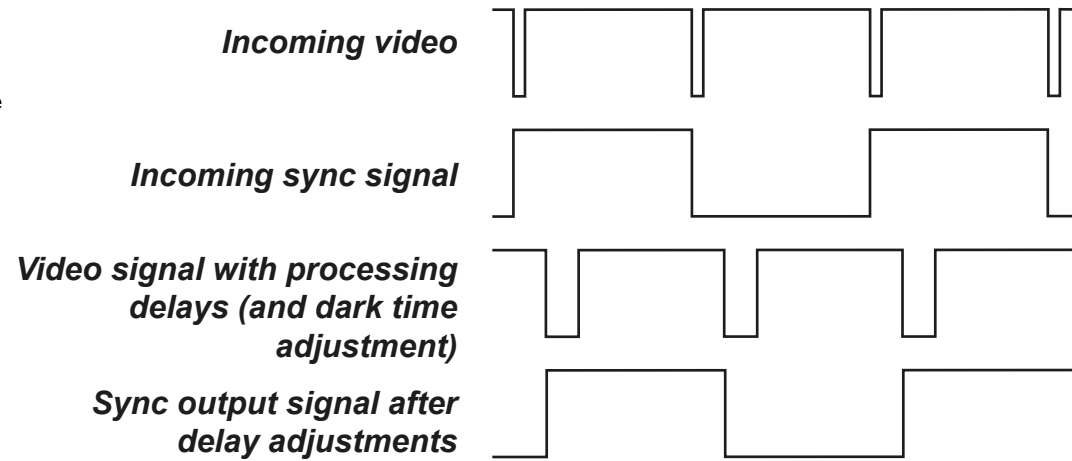

Notes

Laser menu

- **Power Mode**
 - **Eco** will automatically set the laser power to 80%.
 - **Normal** will set the power to 100%.
 - Set to **Custom** if you wish to adjust the power manually.
- **Power Level**
This setting is only available if **Power Mode** is set to **Custom**.
Choose a value between 20 and 100, ranging from 20% to 100% laser power.
- **Constant Brightness**
Once a **Custom Power Mode** has been set, then Constant Brightness can be turned **ON**.
This setting will maintain the brightness until the maximum laser power has been reached. The lower the power level the longer it will be maintained.

Laser	
Power Mode	Normal
Power Level	-----
Constant Brightness	Off



Notes

Setup menu

- **Orientation**
Choose from **Front Tabletop**, **Front Ceiling**, **Rear Tabletop**, **Rear Ceiling** and **Auto-front**.
- **Cooling Condition**
Choose from **Table**, **Ceiling**, **Freetilt** and **Auto**.
- **High Altitude**
Choose from **On**, **Auto** and **Quiet**.
- **Standby Power**
Choose from **SuperECO**, **ECO** and **Normal**.
SuperECO uses minimal power and disables power ON via LAN.
ECO uses a low power setting but enables power ON via Ethernet port only.
Normal enables power ON via both HDBase-T/LAN and Ethernet ports.
- **Screen Setting**
Choose from **16:10**, **16:9** and **4:3**.
- **ColorMax**
Set up user-defined color gamut values.
- **Power On/Off Management**
Access the submenu to set up automatic projector power on and power off.
- **Clock Adjust**
Access the submenu to set current date and local time.
- **Startup Logo**
Set this to **On** if you want the DP logo to show when the projector is first switched on.
- **Blank Screen**
Choose from **Logo**, **Black**, **Blue** and **White**.
- **Auto Source**
If this setting is **On**, the projector will automatically search for an active input source.

Setup	
Orientation	Auto-front
Cooling Condition	Auto
High Altitude	Auto
Standby Power	SuperECO
Screen Setting	16:9
ColorMax	▶
Power on/off Management	▶
Clock Adjust	▶
Startup Logo	On
Blank Screen	Logo
Auto Source	Off
	▼

Notes

-  **Auto-front** automatically detects the projector's position and sets Table or Ceiling orientation accordingly.
-  **Screen Setting** and **Auto Source** are not available with input HDMI 3 or HDMI 4
-  **Screen Setting** is automatically set to 16:9 when smooth picture is active

Highlight the **DOWN** arrow at the bottom of the page and press **ENTER/OK** to navigate to the second Setup menu page.

- **Trigger1 and Trigger 2**

Choose from **Screen, 5:4, 4:3, 16:10, 16:9, 1.88, 2.35, TheaterScope, Source, Unscaled** or **RS232** to determine what will cause each trigger output to activate.

- **Infrared Remote**

Set to **Off** if you wish to disable the remote control.

- **IR Code**

The projector and the remote control need a matching IR code: a two-digit number between **00** and **99**. The default IR code is **00**. This is also a master code, which, if assigned to a remote, will work regardless of the value assigned to the projector.

- **To assign an IR code for the projector:** Select IR code. Use the UP and DOWN arrow buttons to change the values.
- **To assign an IR code for the remote,** press and hold the **ADDR** button on the remote until the On indicator starts flashing. Release the **ADDR** button and while the indicator is still flashing, enter a two digit address using the numeric input buttons. The indicator will flash three times quickly to confirm the change.

- **IR Code Reset**

Use this command to unassign an IR code from the projector. This will revert the **IR Code** value to 00.

To unassign an IR code from the remote control, press and hold **ALT** and **ADDR** simultaneously until the On indicator flashes to confirm the change.

- **OSD Settings**

Access this submenu to adjust the appearance and position of the on-screen display.

- **Memory**

Access this submenu to save up to four presets containing custom combinations of image settings, or to recall a saved preset.

- **Instant Startup**

When **ON** only the Laser will be turned off when the Power off command is given. A subsequent Power On will turn on the laser giving an apparent very fast power on.

- **Standby Period**

Used with Instant Startup. If Instant Startup in **ON** and the projector is powered down then the projector will go to Standby after the selected "Standby Period" 30 minutes, 60 minutes, 90 minutes.

- **HDMI Equaliser**

Select **ON** to activate the HDMI Equalizer. When transmitting signals via a HDMI cable, signal noise can disrupt the information received by the projector. High bandwidth signals, poor quality HDMI cables and longer HDMI cables can increase the signal noise. Use the HDMI Equaliser to improve HDMI signal acquisition.

- **Image Latency**

Select **Fast** for improved latency.

Select **Normal** when image corruption occurs. Image corruption (frame tearing) may occur when a high level of warping is applied to the image and fast latency is selected. See Geometry menu on page 49 for information about image warping.

Setup	
	▲
Trigger-1	Off
Trigger-2	Off
Infrared Remote	On
IR Code	0
IR Code Reset	
OSD Settings	▶
Memory	▶
Instant Startup	Off
Standby Period	30 Min.
HDMI Equalizer	Off
Image Latency	Normal

Notes

 **Trigger-1 and Trigger-2** are not available with input HDMI 3 or HDMI 4. If you turn the remote control off, you can only turn it back on again from the control panel or via the **Projector Controller** application.

 The **Projector Controller** software is available for download from the Digital Projection website, free of charge.

 A wired remote control will also be disabled if **Infrared Remote** is set to **Off**.

Highlight the **UP** arrow at the top of the page and press **ENTER/OK** to go back to the first **Setup** menu page.

ColorMax

ColorMax permits seven point color matching of red, green, blue, yellow, cyan, magenta and white.

You can enter your own gamut values here, or edit values you have imported using the **Projector Controller** software.

Defining your own colorspace with individual x and y coordinates for each color enables you to match not only the whites but each individual color as well.

Highlight the submenu you wish to open and press **ENTER/OK** to confirm your choice.

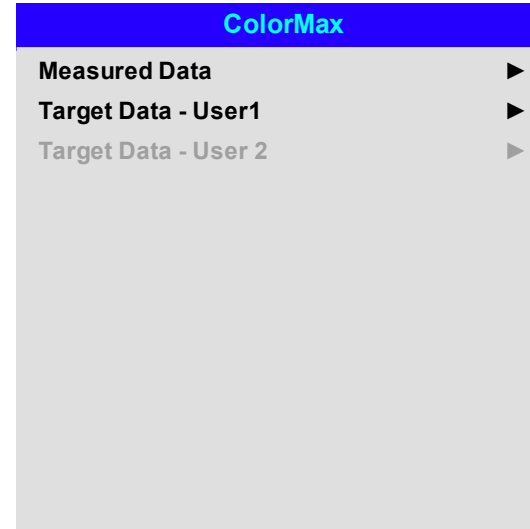

Notes

*The **Projector Controller** software is available for download from the Digital Projection website, free of charge.*

This tool is best used in conjunction with a specialized light meter (a photo spectrometer) to measure color parameters within a particular installation. However, the preloaded generic factory default data set is designed to give more than satisfactory results.

Measured data/ target data

1. Use the **UP** and **DOWN** arrow buttons to highlight a color, then use the **LEFT** and **RIGHT** arrow buttons to navigate to the x or y coordinate.
2. Use the **UP** and **DOWN** arrow buttons to increase and decrease the value, respectively.
3. Exit edit mode:
 - press **ENTER/OK**, if you want to save the edited values.
 - press **EXIT**, if you do not wish to save the edited values
4. If necessary, highlight another color and repeat the procedure.

Measured Data	
Red	x: 0.658 y: 0.339
Green	x: 0.315 y: 0.662
Blue	x: 0.146 y: 0.043
White	x: 0.276 y: 0.283
Reset	

Target Data - User1	
Red	x: 0.640 y: 0.390
Green	x: 0.300 y: 0.600
Blue	x: 0.150 y: 0.060
Yellow	x: 0.419 y: 0.505
Cyan	x: 0.225 y: 0.329
Magenta	x: 0.321 y: 0.154
White	x: 0.285 y: 0.302

Power on / off

- **Auto Power Off**

Set this to **On** if you want the projector to go into STANDBY mode when no input source is detected for 20 minutes.

- **Auto Power On**

Set this to **On** if you want the projector to start up immediately when the mains is connected. Set this to **Off** if you want the projector to go into STANDBY mode when the mains is connected. In this case, the projector will not start up until the **POWER** button is pressed on the control panel or the **ON** button is pressed on the remote control.

- **Scheduled on/off**

Access this submenu to create a weekly schedule for automatic on and off times:

1. Set a schedule:

- Use the **UP** and **DOWN** arrow buttons to highlight a row, then press **ENTER/OK** to enable edit mode.
- Within a row, navigate with the **LEFT** and **RIGHT** arrow buttons. Set values with the **UP** and **DOWN** arrow buttons.
- To exit edit mode, press **ENTER/OK**. Alternatively, press **EXIT** if you don't want the changes to take effect. Move to another row using the **UP** and **DOWN** arrow buttons.

2. To enable the schedule, set Schedule to **On**.

Power on/off Management

Auto Power Off	Off
Auto Power On	Off
Scheduled on-off	▶

Scheduled on-off

	Schedule							Off
	S	M	T	W	T	F	S	Time
On	<input checked="" type="checkbox"/>	<input type="checkbox"/>	<input type="checkbox"/>	<input type="checkbox"/>	<input type="checkbox"/>	<input type="checkbox"/>	<input type="checkbox"/>	12:34
Off	<input checked="" type="checkbox"/>	<input type="checkbox"/>	<input type="checkbox"/>	<input type="checkbox"/>	<input type="checkbox"/>	<input type="checkbox"/>	<input type="checkbox"/>	12:34
On	<input checked="" type="checkbox"/>	<input type="checkbox"/>	<input type="checkbox"/>	<input type="checkbox"/>	<input type="checkbox"/>	<input type="checkbox"/>	<input type="checkbox"/>	12:34
Off	<input checked="" type="checkbox"/>	<input type="checkbox"/>	<input type="checkbox"/>	<input type="checkbox"/>	<input type="checkbox"/>	<input type="checkbox"/>	<input type="checkbox"/>	12:34

Notes

Clock adjust

Use this menu to set date (in **dd:MM:yyyy** format), time (in **HH:mm** format) and time zone.

The date and time set here will affect any schedule created within the **Power On/Off** menu.

Clock Adjust	
Date (dd:MM:yyyy)	30:11:2017
Time (HH:mm)	16:00
Time Zone	UTC 00

OSD settings

- **Language** sets the OSD language.
- **Menu Position** determines where the OSD should appear on the screen when activated.
- **Menu Transparency** sets OSD transparency between 0% (no transparency), 25%, 50% and 75%.
- **Time Out** determines how long the OSD should remain on screen if no buttons are pressed. Choose Always On to disable this feature.
- **Message Box** determines whether projector status messages should appear on the screen.

OSD Settings	
Language	English
Menu Position	Center
Menu Transparency	0
Time Out	30 Seconds
Message Box	On

Notes

Memory

The current image settings can be saved as a preset, which you can recall later. The default settings can be recalled at any time as well.

Up to four custom presets can be stored for each input.

The following settings are saved in a preset:

- From the **Image** menu — **Dynamic Black, Smooth Picture, Gamma, Brightness, Contrast, Saturation, Hue, Sharpness** and **Noise Reduction**
- From the **Color** menu — **Color Space, Color Mode, ColorMax, Color Temperature, Dynamic Black, RGB Lift** and **RGB Gain**
- From the **Geometry** menu — **Aspect Ratio** and **Overscan**.

To recall a saved preset:

- Select **Recall Memory** and press **ENTER/OK**, then select a preset from **Preset A** to **Preset D**. Select **Default** to load factory default values.

To save a preset:

- Select **Save Settings** and press **ENTER/OK**, then choose from **Preset A, Preset B, Preset C** and **Preset D**.

Memory	
Recall Memory	Default
Save Settings	Preset A

Notes

 Presets from one input cannot be applied to another input.

 Presets for inputs HDMI 3 and 4 do not contain all the settings normally stored for other inputs.

 See on page 1 for information about the parameters that can be saved in a memory preset.

Network menu

- **DHCP, IP, Subnet Mask, Gateway, DNS**

Set **DHCP** to **On** if the IP address is to be assigned by a DHCP server, or **Off** if it is to be set here.

If **DHCP** is **On**, it will not be possible to edit IP Address, Subnet Mask, Gateway or DNS.

If **DHCP** is set to **Off**, edit IP Address, Subnet Mask, Gateway and DNS as required.

- **MAC** This field is read-only.
- **AMX** Switch on or off

Network	
DHCP	Off
IP	192.168.000.10
Subnet Mask	255.255.255.000
Gateway	000.000.000.000
DNS	000.000.000.000
MAC	00:18:28:2d:f2:06
AMX	Off

Notes

PIP menu

- **PIP** Turn PIP on and off.
- **Source** Select an input source for the PIP image. Any combinations are possible between main and PIP input source, as long as one of the inputs is either **DisplayPort** or **3G-SDI**.
- **Position** Set the location of the PIP image on the screen. Choose from **Top-Left**, **Top-Right**, **Bottom-Left**, **Bottom-Right** and **PBP**.

PIP	
PIP	Off
Source	HDMI1
Position	Top-Left

Notes

 *PIP functionality is not available with inputs HDMI 3 and HDMI 4*

Information menu

This menu gives information about software and hardware configuration, input source and laser operating times. It also allows you to restore the factory default settings.

Information	
Model Name	E-Vision Laser 11000 4K
Serial Number	X000XXXXX0000
Software Version 1	MD03-SE10-FE09
Software Version 2	STEP_D08-24-17-3120
Software Version 3	2.0.16.0-P503
Active / PIP Source	HDMI 1
Signal Format	▶
Laser Hours	2
System Status	▶
Thermal Status	▶
Factory Reset	

Signal format

Signal Format	
Active Source	
Timing	1080p/60Hz
H Refresh	67.500 KHz
V Refresh	60.00 Hz
Pixel Clock	148.500 MHz
PIP Source	
Timing	576p/50Hz
H Refresh	31.250 KHz
V Refresh	50.00 Hz
Pixel Clock	27.0 MHz

Notes

 **PIP Source** items are not available with input HDMI 3 or HDMI 4.

System status**System Status**

Atmospheric Pressure	98988 Pa (116m)
AC Voltage	160V - 264V
Ceiling Mode	0
Tilt Angle	4 deg
Portrait Angle	0 deg
Altitude Mode	Auto
Laser Power	100%
License Key	License Pass, Timeout, Not Expired
Constant Brightness	Off

Notes**Thermal status****Thermal Status**

Inlet 1-2 Temp.	24 / 34 (C)
DMD Temp.	38 (C)
LD 1-2 Temp.	49 / 42 (C)
Fan 1-3 Speed	1399 / 1402 / 4391
Fan 4-6 Speed	1310 / 1200 / 1205
Fan 7-9 Speed	1211 / 1407 / 1410
Fan 10-12 Speed	0 / 3005 / 3007
Fan 13 - 15 Speed	2986 / 2984 / 2984
Fan 16-18 Speed	3020 / NA / NA
Water Pump Speed	3506

Factory reset

To restore the factory default settings:

1. Navigate to **Factory Reset** and press **ENTER/OK**.
2. When prompted, press **ENTER/OK** to confirm your choice, or press **EXIT** to cancel.

Information	
Model Name	E-Vision Laser 11000 4K
Serial Number	X000XXXXX0000
Software Version 1	MD03-SE10-FE09

Factory Reset	
Warning All user settings will be lost	
Press OK to confirm Press Exit to cancel	
Thermal Status	▶
Factory Reset	OK

Notes

 Factory reset does not reset the Network settings, or High Altitude mode

Served web pages

The served web pages allow you to control the projector remotely via LAN.

The default IP address is **192.168.0.100**.

Notes

The screenshot displays the Digital Projection web interface. At the top is the logo with a rainbow bar. A left-hand navigation menu contains the following items: Projector Status, Projector Control, Crestron RoomView, Network Setup, Alert Mail Setup, Date/Time Setup, Error Log, and DP OSD Function. Below the menu are three buttons: PicMute, OSD, and Freeze. The main content area is divided into two sections: Projector Information and LAN Information.

Projector Information

Model	E-Vision Laser 4K	
Serial Number	W714ZETCY0003	
Software Version 1	MD28-VD27-FD09-0.0.356	
Software Version 2	STEP_D08-24-17-3120	
Software Version 3	2.0.16.0-P503	
Power Status	Power On	
Input	HDMI 1	
Laser Status	Power : On	Runtime : 19 H
Projection Mode	Auto Front	
High Altitude	Auto	
Inlet Temperature	23 / 34	°C
DMD Temperature	34	°C
LD Temperature	46 / 42	°C
Diagnostic Status	No Error	

LAN Information

MAC address	00:18:23:50:92:DA
-------------	-------------------



- Projector Status
- Projector Control**
- Crestron RoomView
- Network Setup
- Alert Mail Setup
- Date/Time Setup
- Error Log
- DP OSD Function

Hot Key

- PicMute
- OSD
- Freeze

State Control

Power

- On
- Off

Input Selection

- DisplayPort
- HDMI 1
- HDMI 2
- HDBaseT
- 3G-SDI
- HDMI 3 (3D)
- HDMI 4 (3D)

Lens Control

Zoom In Focus In



Zoom OUT Focus OUT

Shift

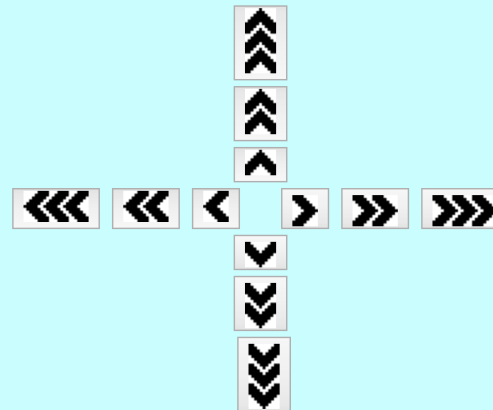

Notes

The screenshot displays the Digital Projection web interface. At the top, there is a navigation bar with 'Tools', 'Info', and 'Contact IT Help' links. Below this is the 'DIGITAL PROJECTION' logo. A 'Power' button is visible. The main content area is titled 'Source List' and features a list of input sources: DisplayPort, HDMI 1 (highlighted), HDMI 2, HDBaseT, and 3G-SDI. To the right of the list is a control panel with buttons for Menu, Auto, Enter, Blank, Source, and Exit. Below the source list are buttons for Freeze, Contrast, Brightness, and Sharpness. The bottom of the interface includes the 'CRESTRON connected' logo and 'Expansion Options' text. A 'Back' button is located in the bottom left corner.

Notes



- Projector Status
- Projector Control
- Creston RoomView
- Network Setup**
- Alert Mail Setup
- Date/Time Setup
- Error Log
- DP OSD Function

Hot Key

- PicMute
- OSD
- Freeze

NetWork

DHCP: On Off

IP Address: 192 . 168 . 0 . 100

Subnet Mask: 255 . 255 . 255 . 0

Gateway: 192 . 168 . 0 . 254

DNS Server: 192 . 168 . 0 . 1

Save Settings

AMX: Off ON

CAUTION: Incorrect settings may cause the projector to lose network connectivity. Please close webpage and reload when you settings.

Notes



- Projector Status
- Projector Control
- Crestron RoomView
- Network Setup
- Alert Mail Setup**
- Date/Time Setup
- Error Log
- DP OSD Function

Hot Key

PicMute OSD

Freeze

Server Setup

SMTP Server: **Port:**

User Name:

Password:

Mail

E-mail Alert: Enable Disable

From:

To:

CC:

Projector Name:

Location:

Test

Periodic Report

days

Sun Mon Tue Wed Thu Fri Sat

Times

<input type="checkbox"/> 00:00	<input type="checkbox"/> 01:00	<input type="checkbox"/> 02:00	<input type="checkbox"/> 03:00
<input type="checkbox"/> 04:00	<input type="checkbox"/> 05:00	<input type="checkbox"/> 06:00	<input type="checkbox"/> 07:00
<input type="checkbox"/> 08:00	<input type="checkbox"/> 09:00	<input type="checkbox"/> 10:00	<input type="checkbox"/> 11:00
<input type="checkbox"/> 12:00	<input type="checkbox"/> 13:00	<input type="checkbox"/> 14:00	<input type="checkbox"/> 15:00
<input type="checkbox"/> 16:00	<input type="checkbox"/> 17:00	<input type="checkbox"/> 18:00	<input type="checkbox"/> 19:00
<input type="checkbox"/> 20:00	<input type="checkbox"/> 21:00	<input type="checkbox"/> 22:00	<input type="checkbox"/> 23:00

Notes



- Projector Status
- Projector Control
- Crestron RoomView
- Network Setup
- Alert Mail Setup
- Date/Time Setup**
- Error Log
- DP OSD Function

Hot Key

- PicMute
- OSD
- Freeze

Time Zone:

Time Zone:

Select Local time zone, Current zone is UTC +00:00

Time:

Date: e.g.2000.01.01

Clock: e.g.23:59

Current time is set to :2017.12.01 ; 09:17

Notes



- Projector Status
- Projector Control
- Creston RoomView
- Network Setup
- Alert Mail Setup
- Date/Time Setup
- Error Log**
- DP OSD Function

Hot Key

PicMute OSD

Freeze

Projector Error Log

ErrLog: 0 / Current PowerOn times: 9

No	Code	PwrOn	L1(Hr/Pwr)	T(Ti/Tc)	Desc
----	------	-------	------------	----------	------

[Page 1](#) [Page 2](#)

Notes

DIGITAL PROJECTION

Page 1 Page 2 Page 3

Projector Status

Projector Control

Crestron RoomView

Network Setup

Alert Mail Setup

Date/Time Setup

Error Log

DP OSD Function

Hot Key
PicMute OSD Freeze

Input

- Input

Test Pattern

Exit Test Pattern

Lens

- Lens Lock off on
- CenterLens Do
- Lens Type non-UST Lens UST Lens
- LensMemory Save Load Clear

Image

- PictureMode
- DynamicBlack off on
- Light Off Timer
- Smooth Picture
- Gamma
- Brightness
- Constrast
- Staturation
- Hue
- Sharpness
- Noise Reduction
- Freeze
- Resync

color

- ColorSpace
- ColorMode
- ColorMax
- Manual Color Matching
 - Red**
 - Hue
 - Saturation
 - Gain
 - Green**
 - Hue
 - Saturation
 - Gain
 - Blue**
 - Hue
 - Saturation
 - Gain
 - Yellow**
 - Hue
 - Saturation
 - Gain
 - Magenta**
 - Saturation
 - Saturation
 - Gain
 - Cyan**
 - Hue
 - Saturation
 - Gain
 - White Balance**
 - Red
 - Green
 - Blue

Manual Color Matching Reset

- Manual Color Matching
 - Red**
 - Hue
 - Saturation
 - Gain
 - Green**
 - Hue
 - Saturation
 - Gain
 - Blue**
 - Hue
 - Saturation
 - Gain
 - Yellow**
 - Hue
 - Saturation
 - Gain
 - Magenta**
 - Saturation
 - Saturation
 - Gain
 - Cyan**
 - Hue
 - Saturation
 - Gain
 - White Balance**
 - Red
 - Green
 - Blue
- Color Temperature Manual Color Matching Reset
- Gains and Lifts
 - Red Lift
 - Green Lift
 - Blue Lift
 - Red Gain
 - Green Gain
 - Blue Gain

Gains and Lifts Reset

Page 1 Page 2 Page 3

Notes



- Projector Status
- Projector Control
- Crestron RoomView
- Network Setup
- Alert Mail Setup
- Date/Time Setup
- Error Log
- DP OSD Function
- Hot Key
 - PicMute
 - OSD
 - Freeze

Page 1 Page 2 Page 3

geometry

- Aspect Ratio Source
- Digital Zoom
 - Digital Zoom
 - Digital Pan
 - Digital Scan
- Overscan Digital Zoom Reset Off
- Blanking
 - Top
 - Bottom
 - Left
 - Right
- Blanking Reset
- Keystone
 - H Keystone
 - V Keystone
 - Rotation
- Keystone Reset
- 4 Corners
 - Top Left Corner X
 - Top Left Corner Y
 - Top Right Corner X
 - Top Right Corner Y
 - Bottom Left Corner X
 - Bottom Left Corner Y
 - Bottom Right Corner X
 - Bottom Right Corner Y
- 4 Corners Reset
- Rotation
 - Rotation Reset
- Pincushion/Barrel
 - H Pin/Barrel
 - V Pin/Barrel
 - Keystone
 - H Keystone
 - V Keystone
 - Rotation
- Pincushion/Barrel Reset
- Arc
 - Top
 - Bottom
 - Left
 - Right
- Arc Reset
- Custom Warp Off

edgeblend

- Bottom
- Left
- Right
- Arc Reset
- Custom Warp Off

edgeblend

- Edge Blend off on
- Align Pattern off on
- Blend Width
 - Top
 - Bottom
 - Left
 - Right
- Black Level Uplift
 - Select Area
 - Top
 - Bottom
 - Left
 - Right
 - Color Adjustment
 - All
 - Red
 - Green
 - Blue
- Edgeblend Reset

3d

- 3D Format Off
- DLP Link off on
- Eye Swap Normal Reverse
- Dark Time 1.95ms
- 3D Sync
 - Offset
 - Reference External Internal

laser

- Power Mode Custom
- Power Level
- Constant Brightness Off

Page 1 Page 2 Page 3

Notes



- Projector Status
- Projector Control
- Creston RoomView
- Network Setup
- Alert Mail Setup
- Date/Time Setup
- Error Log
- DP OSD Function**

Hot Key
PicMute OSD Freeze

Page 1 Page 2 Page 3

setup

- Orientation (Auto-front)
- Cooling Condition (Auto)
- High Altitude (Auto)
- Standby Mode (SuperECO (< 0.5W, No Lan access))
- Screen Setting (16:9)
- ColorMax

Measured Data

Red	X:0.650	Y:0.341
Green	X:0.343	Y:0.622
Blue	X:0.141	Y:0.021
White	X:0.305	Y:0.343

Measured Data Save Measured Data Reset

Target Data - User 1

Red	X:0.638	Y:0.334
Green	X:0.333	Y:0.589
Blue	X:0.154	Y:0.058
Yellow	X:0.419	Y:0.505
Cyan	X:0.243	Y:0.323
Magenta	X:0.321	Y:0.154
White	X:0.308	Y:0.335

Target Data - User 2

Red	X:0.638	Y:0.334
Green	X:0.333	Y:0.589
Blue	X:0.154	Y:0.058
Yellow	X:0.419	Y:0.505
Cyan	X:0.243	Y:0.323
Magenta	X:0.321	Y:0.154
White	X:0.308	Y:0.335

- Power On/Off
- Auto Power Off (off/on)
- Auto Power On (off/on)
- Scheduled on/off (off/on)

	Sun	Mon	Tue	Wed	Thu	Fri	Sat	Time(HH:MM)
On								01:00
Off						✓		01:00
On								01:00
Off								01:00

- Startup Logo (off/on)
- Blank Screen (Black)
- Trigger-1 (Off)
- Trigger-2 (Off)
- Auto Source (off/on)
- Infrared Remote (off/on)
- IR Code (0)
- OSD Setting
- Language (English)
- Menu Position (Center)

- Menu Transparency (0)
- Time Out (Always On)
- Message Box (off/on)
- Memory
- Recall Memory (Default)
- Save Settings (Preset A)
- Instant Startup (off/on)
- Standby Period (30 Min.)

- pip
- PIP (off/on)
 - Source (3G-SDI)
 - Position (Top-Left)

information

• Model Name	E-Vision Laser 4K
• Serial Number	W714ZETCY0003
• Software Version 1	MD28-VD27-FD09-0.0.356
• Software Version 2	STEP_D08-24-17-3120
• Software Version 3	2.0.16.0-P503
• Active/PIP Source	HDMI1/NA
• Signal Format	HDMI1
Active Source	HDMI1
Timing	3840x2160
H Refresh	67.4 kHz
V Refresh	30.0 Hz
Pixel Clock	296.90 MHz
PIP Source	NA
PIP Timing	NA
PIP H Refresh	NA
PIP V Refresh	NA
PIP Pixel Clock	NA
• Laser Hours	19
• System Status	
Atmospheric Pressure	101258 Pa(5 m)
AC Voltage	180V-264V
Ceiling Mode	Table Top
Tilt Angle	0

Notes

PIP Pixel Clock	NA
• Laser Hours	19
• System Status	
Atmospheric Pressure	101258 Pa(5 m)
AC Voltage	180V-264V
Ceiling Mode	Table Top
Tilt Angle	0
Portrait Angle	0
Altitude Mode	Auto
Laser Power	100
License Key	License Pass, Timeout Not Expired
• Thermal Status	
Inlet 1-2 Temp.	23 / 34
DMD Temp	34
LD 1-2 Temp	46 / 42
Fan 1-3Speed	1412/1415/1409
Fan 4-6Speed	1415/1195/1209
Fan 7-9Speed	1242/1408/1400
Fan 10-12Speed	NA/NA/2983
Fan 13-15Speed	2983/NA/3006
Fan 16Speed	3005
Water Pump Speed	3718
Factory Reset	

[Page 1](#) [Page 2](#) [Page 3](#)

Notes

This page is intentionally left blank

DIGITAL 
PROJECTION

A Delta Associate Company

E-Vision Laser 11000 4K-UHD Series

High Brightness Digital Video Projector

REFERENCE GUIDE



Choosing a lens

A number of lenses are available. Which lens you choose depends on the screen size, image aspect ratio, throw distance and light output.

The following table shows all available lenses in order of their throw ratios:

Throw Ratio	Focus Range	Lens Shift	Part Number
0.377 : 1 fixed (UST)	0.82 m - 2.71 m	Depends on image size, see UST Lens Installation Guide (separate document)	117-341
0.74 - 0.93 : 1 zoom	1.02 m - 12.7 m	V: 0.5 (U) 0.3 (D) frame H: 0.1 (L) 0.2 (R) frame	115-339
0.76 : 1 fixed	0.81 m - 5.08 m	none	112-499
1.24 - 1.78 : 1 zoom	1.33 m - 11.73 m	V: 0.5 (U) 0.3 (D) frame H: 0.1 (L) 0.2 (R) frame	112-500
1.71 - 2.25 : 1 zoom	1.83 m - 14.9 m	V: 0.5 (U) 0.3 (D) frame H: 0.1 (L) 0.2 (R) frame	112-501
2.20 - 3.67 : 1 zoom	2.36 m - 24.2 m	V: 0.5 (U) 0.3 (D) frame H: 0.1 (L) 0.2 (R) frame	112-502
3.54 - 5.36 : 1 zoom	3.8 m - 35.35 m	V: 0.5 (U) 0.3 (D) frame H: 0.1 (L) 0.2 (R) frame	112-503
5.24 - 8.27 : 1 zoom	5.59 m - 54.8 m	V: 0.5 (U) 0.3 (D) frame H: 0.1 (L) 0.2 (R) frame	112-504

To choose a lens, calculate the **throw ratio** required. Allow a tolerance of +/- 3% in the throw ratio calculation.

Notes

Throw distance calculations are based on the distance from the outer end of the lens, which varies from lens to lens.



The lens extension is the distance between the front of the projector chassis and the outer end of the lens when it is fully extended.



Refer to the projector CAD drawings for individual lens extension figures.



*The **0.377 : 1 fixed lens** has no adjustable shift value. However, the lens has an inherent offset depending on image size. See the UST documentation published separately on the Digital Projection website.*



*The **0.74 - 0.93 : 1 zoom lens** has a feature that permits focus correction for curved screens. The front ring of the lens is a manual control that provides focus curvature adjustment to correct for the different focal distances between center and corner.*

Basic calculation

Identify the required lens by calculating the **throw ratio**.

A **throw ratio** is the ratio of the throw distance **2** to the screen width **1**:

$$\text{ThrowRatio} = \text{ThrowDistance} / \text{ScreenWidth}$$

1. Use the formula above to obtain the required throw ratio.
2. Allow a tolerance of +/- 3% in the throw ratio calculation and match the throw ratio with a lens from the table below:

Throw ratios	Focus range
0.377 : 1 fixed (UST)	0.82 m - 2.71 m
0.74 - 0.93 : 1 zoom	1.02 m - 12.7 m
0.76 : 1 fixed	0.81 m - 5.08 m
1.24 - 1.78 : 1 zoom	1.33 m - 11.73 m
1.71 - 2.25 : 1 zoom	1.83 m - 14.9 m
2.20 - 3.67 : 1 zoom	2.36 m - 24.2 m
3.54 - 5.36 : 1 zoom	3.8 m - 35.35 m
5.24 - 8.27 : 1 zoom	5.59 m - 54.8 m

3. Ensure the required throw distance is within the range covered by the lens.

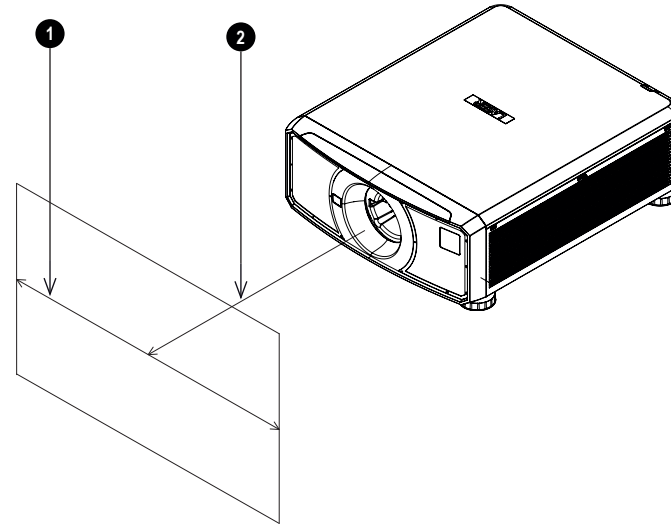

Notes

The basic calculation on this page does not take into consideration DMD™ and image size, which could affect the throw ratio. See Full lens calculation on page 99 for a more complex and realistic calculation.

When calculating the throw ratio, be sure to use identical measurement units for both the throw distance and the screen width.

See Choosing a lens on the previous page for information about individual lens part numbers

Basic calculation example

1. Calculate the throw ratio using the formula.
Your screen is **4.5m** wide and you wish to place the projector approximately **11m** from the screen. The throw ratio will then be
 $11 \div 4.5 = \mathbf{2.44}$
2. Match the result with the lens table.
The lens matching a throw ratio of 2.44 is the **2.20 - 3.67 : 1 zoom lens**.
3. **Check whether the lens covers the required throw distance.**
The focus range quoted for the 2.20 - 3.67 : 1 zoom lens is **2.36 - 24.2m**. The required distance of 11m is within the range.

INFORMATION YOU NEED FOR THIS CALCULATION

The throw ratio formula:

$$\mathbf{ThrowRatio = ThrowDistance / ScreenWidth}$$

Allow a tolerance of +/- 3% in the throw ratio calculation.

The lens table:

Throw ratios	Focus range
0.377 : 1 fixed (UST)	0.82 m - 2.71 m
0.74 - 0.93 : 1 zoom	1.02 m - 12.7 m
0.76 : 1 fixed	0.81 m - 5.08 m
1.24 - 1.78 : 1 zoom	1.33 m - 11.73 m
1.71 - 2.25 : 1 zoom	1.83 m - 14.9 m
2.20 - 3.67 : 1 zoom	2.36 m - 24.2 m
3.54 - 5.36 : 1 zoom	3.8 m - 35.35 m
5.24 - 8.27 : 1 zoom	5.59 m - 54.8 m

Notes

 The basic calculation on this page does not take into consideration DMD™ and image size, which could affect the throw ratio. See Full lens calculation on the facing page for a more complex and realistic calculation.

 See Choosing a lens on page 96 for information about individual lens part numbers.

Full lens calculation

Introducing TRC

The choice of lens will affect the image size and will address discrepancies between the DMD™ resolution and the source.

When an image fills the height of the DMD™ but not the width, it uses less than 100% of the DMD™ surface. A lens chosen using the basic formula may produce an image that is considerably smaller than the actual screen.

To compensate for loss of screen space in such situations, you need to increase the throw ratio using a **Throw Ratio Correction (TRC)**.

Example

Fig. 1 illustrates a 4:3 image within a 16:9 display

When a 16:9 projector is used for a 4:3 image, the image does not fill the width of the DMD™, creating a **pillarboxing** effect - blank spaces to the left and right.

Fig. 2 shows the same image projected on a 4:3 screen using a standard lens (chosen with the basic calculation).

The DMD™ accurately fills the width of the screen; however, the pillarboxing is now part of the projected image and is transferred to the screen.

The DMD™ does not fill the height of the screen, which has caused **letterboxing** - further blank spaces at the top and bottom of the screen.

The image is now surrounded by blank space, which can be removed if the throw ratio is increased.

Fig. 3 shows the image projected on the same screen with a lens chosen using TRC. The increased throw ratio has allowed the 4:3 image to fill the 4:3 screen seamlessly



Fig 1

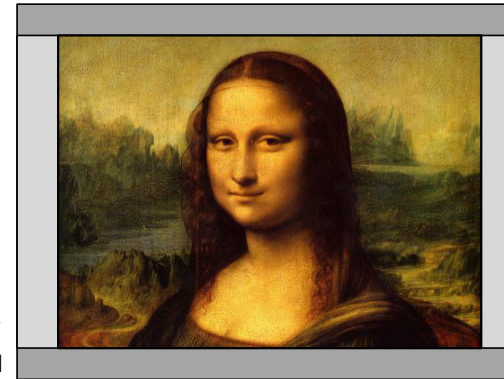



Fig 2



Fig 3

Notes

 TRC can only be applied if greater than 1. If TRC is 1 or less, disregard it and calculate the throw ratio using the basic formula.

Calculating TRC

To calculate TRC, use the following formula:

$$TRC = 1.78(DMD^{\text{TM}} \text{ AspectRatio}) / \text{Source AspectRatio}.$$

TRC table

Alternatively, you can save time by referencing the following table, which shows the TRC value for some popular image formats:

2.35:1 (Scope)	3840 x 1634 pixels	TRC < 1, not used
1.85:1 (Flat)	3840 x 2075 pixels	TRC < 1, not used
1.78:1 (16:9)	3840 x 2160 pixels	TRC = 1, not used (native aspect ratio)
1.6:1 (16:10)	3456 x 2160 pixels	TRC = 1.11
1.33:1 (4:3)	2873 x 2160 pixels	TRC = 1.33
1.25:1 (5:4)	2700 x 2160 pixels	TRC = 1.42

Calculating the throw ratio with TRC

- For TRC > 1, amend the basic throw ratio formula as follows:

$$\text{ThrowRatio} = \text{ThrowDistance} / \text{ScreenWidth} * TRC$$

Allow a tolerance of +/- 3% in the throw ratio calculation.

- Once a throw ratio is established, identify the matching lens from the table:

Throw ratios	Focus range
0.377 : 1 fixed (UST)	0.82 m - 2.71 m
0.74 - 0.93 : 1 zoom	1.02 m - 12.7 m
0.76 : 1 fixed	0.81 m - 5.08 m
1.24 - 1.78 : 1 zoom	1.33 m - 11.73 m
1.71 - 2.25 : 1 zoom	1.83 m - 14.9 m
2.20 - 3.67 : 1 zoom	2.36 m - 24.2 m
3.54 - 5.36 : 1 zoom	3.8 m - 35.35 m
5.24 - 8.27 : 1 zoom	5.59 m - 54.8 m

- Ensure the required throw distance is within the range of the matching lens.

Notes



TRC can only be applied if greater than 1. If TRC is 1 or less, disregard it and calculate the throw ratio using the basic formula.



TRC can only be applied if greater than 1. If TRC is 1 or less, disregard it and calculate the throw ratio using the basic formula.

Full lens calculation example

Your screen is **4.5m** wide; you wish to place the projector approximately **11m** from the screen. The source is **4:3**.

1. Calculate TRC as follows:
TRC = 1.78 / 1.33 = 1.34.
2. Calculate the throw ratio:
Throw ratio = 11 / 4.5 x 1.34 = **1.82**
3. Allow a tolerance of +/- 3% in the throw ratio calculation and find a match in the lens table.
The table shows that the matching lens is **the 1.71 - 2.25 : 1 zoom lens**.
4. Check whether the lens covers the required throw distance.
The focus range quoted for the 1.71 - 2.25 : 1 zoom lens is **1.83m - 14.9m**. The required distance of 11 m is within the range.

INFORMATION YOU NEED FOR THESE CALCULATIONS

The TRC formula

TRC = DMD™ AspectRatio / Source AspectRatio

The TRC table (to use instead of the formula)

2.35:1 (Scope)	TRC not used
1.85:1 (Flat)	TRC not used
1.78:1 (16:9)	TRC not used (native aspect ratio)
1.6:1 (16:10)	TRC = 1.11
1.33:1 (4:3)	TRC = 1.33
1.25:1 (5:4)	TRC = 1.42

The throw ratio formula

ThrowRatio = ThrowDistance / ScreenWidth * TRC

Allow a tolerance of +/- 3% in the throw ratio calculation.

The lens table:

Throw ratios	Focus range
0.377 : 1 fixed (UST)	0.82 m - 2.71 m
0.74 - 0.93 : 1 zoom	1.02 m - 12.7 m
0.76 : 1 fixed	0.81 m - 5.08 m
1.24 - 1.78 : 1 zoom	1.33 m - 11.73 m
1.71 - 2.25 : 1 zoom	1.83 m - 14.9 m
2.20 - 3.67 : 1 zoom	2.36 m - 24.2 m
3.54 - 5.36 : 1 zoom	3.8 m - 35.35 m
5.24 - 8.27 : 1 zoom	5.59 m - 54.8 m

Notes

Screen requirements

Fitting the image to the display

If the source image supplied to the projector is smaller than the 4K-UHD resolution, the image will not fill the display. The following examples show how a number of common formats may be displayed, depending on your DMD™ resolution.

4K-UHD images displayed full width

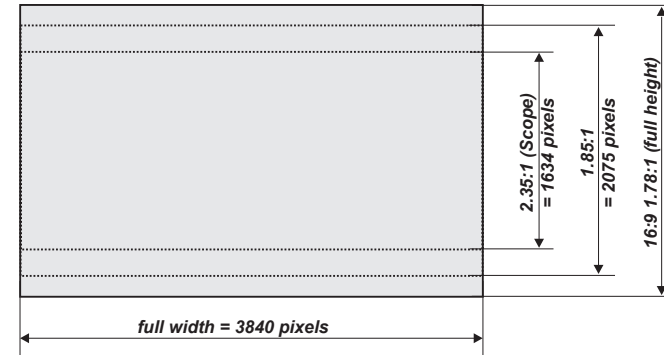

4K-UHD images displayed with a height of 2160 pixels

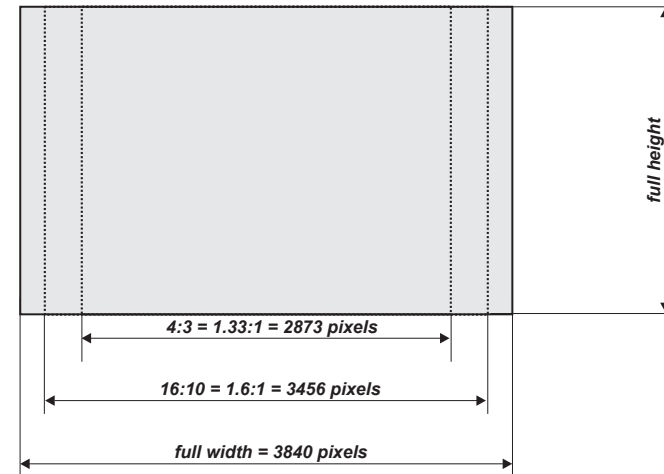

Notes



These pixel dimensions are correct when Smooth Picture is ON. When Smooth Picture is OFF these values will be based on the full native DMD size of 2716 x 1528.

4K-UHD images displayed full height

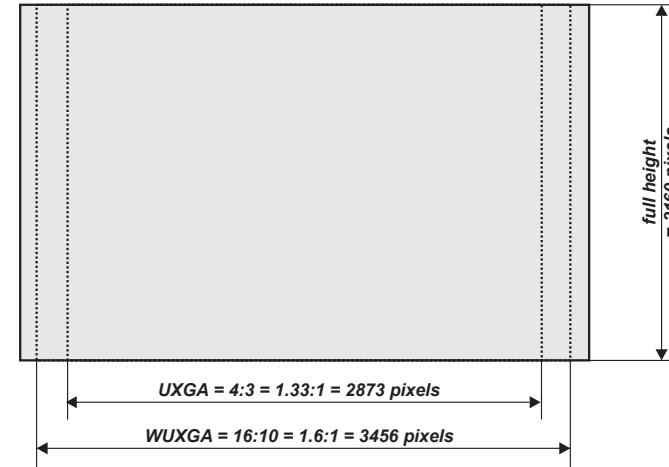

Notes

Diagonal screen sizes

Screen sizes are sometimes specified by their diagonal size (D). When dealing with large screens and projection distances at different aspect ratios, it is more convenient to measure screen width (W) and height (H).

The example calculations below show how to convert diagonal sizes into width and height, at various aspect ratios.

2.35:1 (Scope)

$$W = D \times 0.92 \quad H = D \times 0.39$$

1.85:1

$$W = D \times 0.88 \quad H = D \times 0.47$$

16:9 = 1.78:1 (native aspect ratio for 4K-UHD projectors)

$$W = D \times 0.87 \quad H = D \times 0.49$$

16:10 = 1.6:1

$$W = D \times 0.85 \quad H = D \times 0.53$$

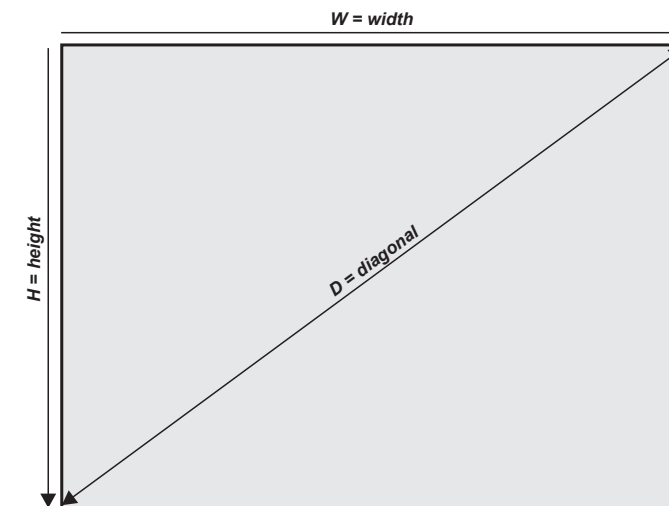

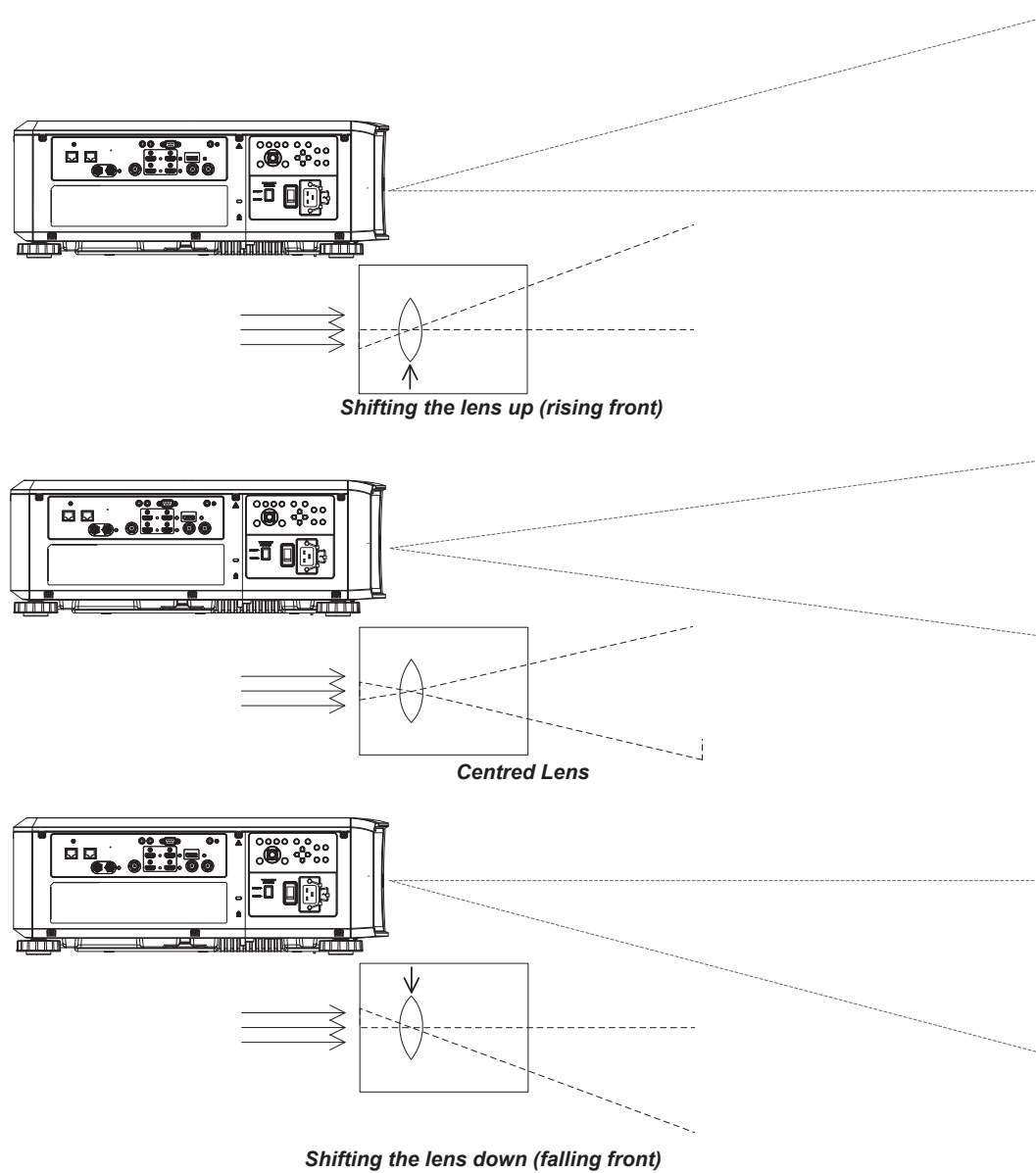

Positioning the image

The normal position for the projector is at the centre of the screen. However, you can set the projector above or below the centre, or to one side, and adjust the image using the **Lens shift** feature (known as **rising and falling front**) to maintain a geometrically correct image.



Notes

 See **Lens control** on page 40 for more information on shifting the lens.

 Whenever possible, position the projector so that the lens is centered for the highest quality image

Any single adjustment outside the ranges specified on the following page may result in an unacceptable level of distortion, particularly at the corners of the image, due to the image passing through the periphery of the lens optics.

If the lens is to be shifted in two directions combined, the maximum range without distortion will be somewhat less, as can be seen in the illustrations.

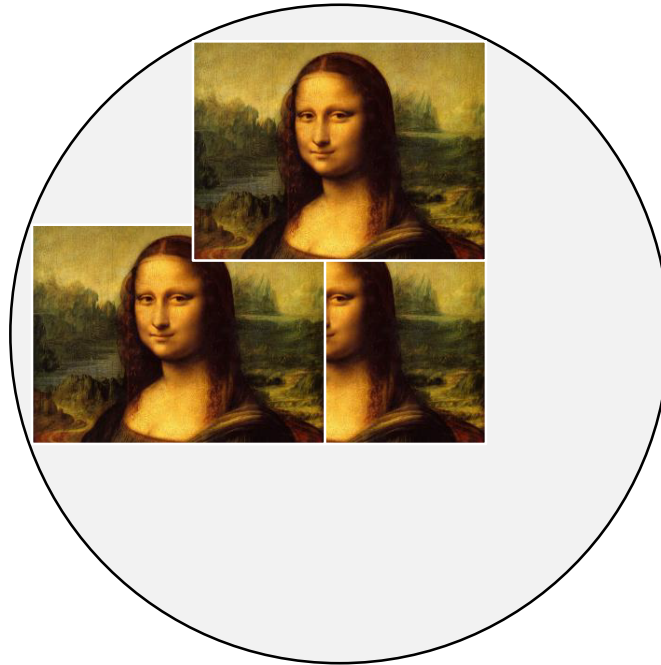

Full horizontal or vertical shift

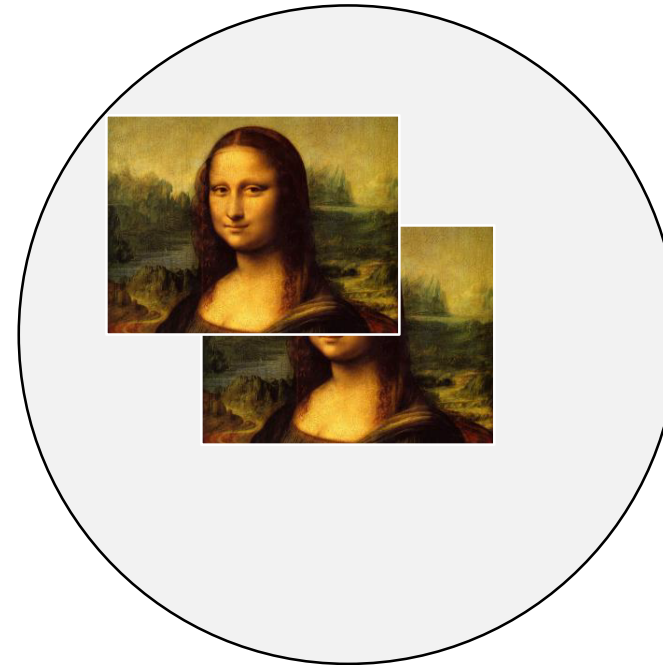

Combined shift is reduced

Notes

 See *Lens control* on page 40 for more information on shifting the lens.

Aspect ratios explained

The appearance of a projected image on the screen depends on a combination of the following:

- The display resolution is **4K-UHD** with a 3840 x 2160 resolution, corresponding to an aspect ratio of 16:9
- The aspect ratio of the input signal: usually **4:3**, **16:9** or **16:10**
- The value of the **Aspect Ratio** setting of the projector:
 - **16:9**, **4:3**, **16:10** and **5:4** stretch the image to the selected aspect ratio. **16:9** leaves black bars at the top and bottom of the screen (letterboxing effect); **4:3** and **5:4** leave black bars at the sides of the screen (pillarboxing).
 - **TheaterScope** is a special setting used in combination with an anamorphic lens, an optional accessory. It removes letterboxing from a 2.35:1 source packed into a 16:9 frame.
 - **Source** shows the image with its original aspect ratio, if this does not match the native aspect ratio of the DMD™, then the image will be scaled to either fit the full width or height of the display.

Aspect ratios examples

1. Unused screen areas

Source: 4:3

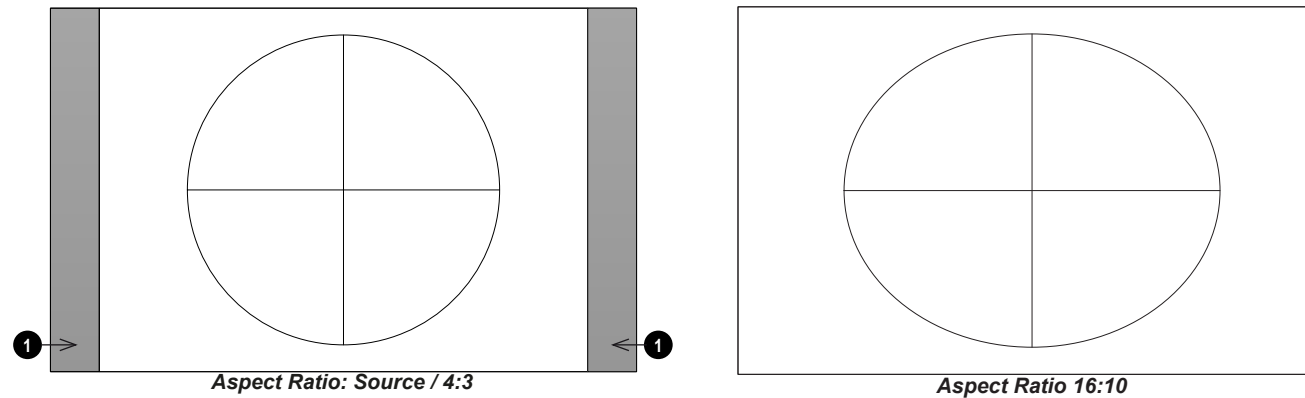

Notes

Source: 16:9

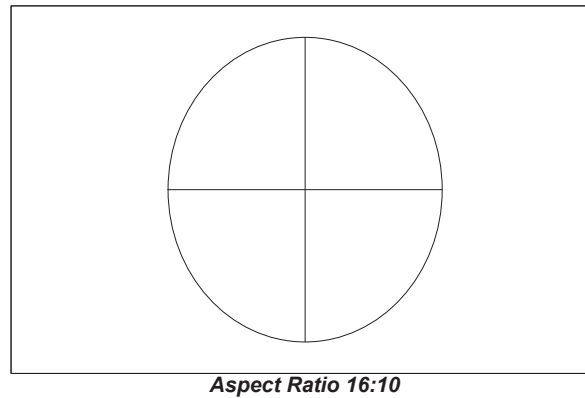
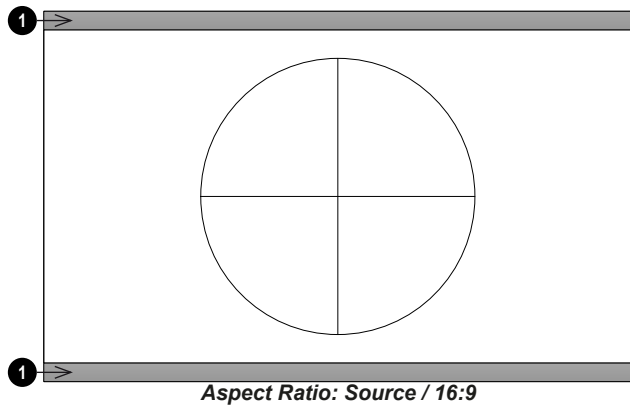

Source: 16:10 (native)

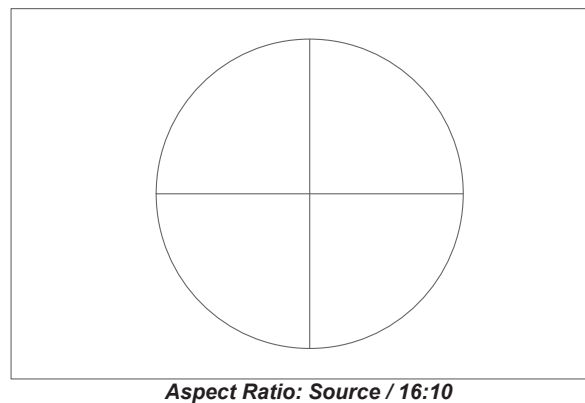

Notes

Aspect ratio example: TheatreScope

The TheaterScope setting is used in combination with an anamorphic lens to restore 2.35:1 images packed into a 16:9 frame. Such images are projected with black lines at the top and bottom of the 16:9 screen to make up for the difference in aspect ratios.

Without an anamorphic lens and without the TheaterScope setting applied, a 16:9 source containing a 2.35:1 image looks like this:

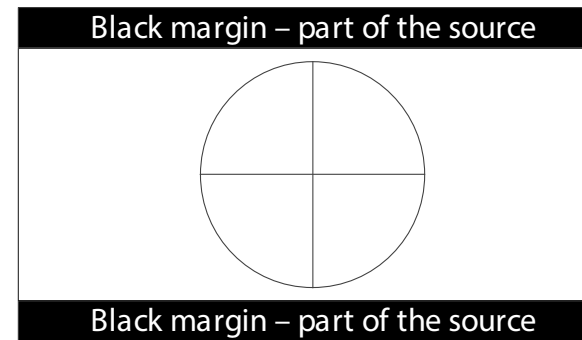

If we change the setting to TheaterScope, the black lines will disappear but the image will stretch vertically to reach the top and bottom of the DMD™:

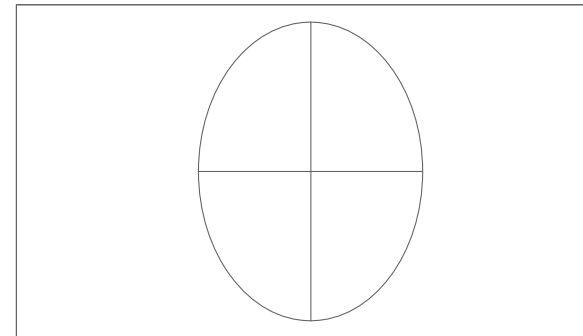

An anamorphic lens will stretch the image horizontally, restoring the original 2.35 ratio:

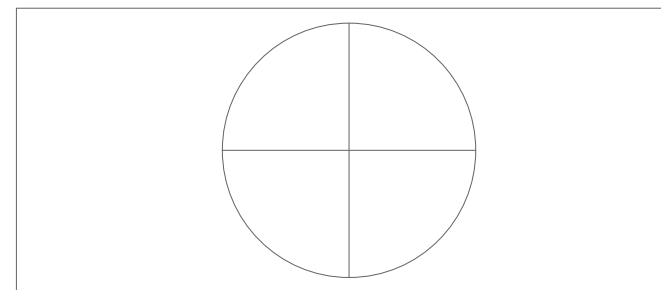

Notes

Appendix A: supported signal input modes

2D formats

Signal Format	Resolution	Frame Rate (Hz)	Display Port	HDMI 1/2 & HDBaseT				HD/SDI/3G	HDMI3/4		Output Frame Rate (Hz)
				RGB	YUV 8-bit	YUV 10-bit	YUV 12-bit		RGB	YUV 8/10/12-bit	
PC	640 x 480	59.94	✓	✓						60	
	640 x 480	74.99	✓	✓						60	
	640 x 480	85	✓	✓						60	
	800 x 600	60.32	✓	✓						60	
	800 x 600	75	✓	✓						60	
	800 x 600	85.06	✓	✓						60	
	848 x 480	47.95	✓	✓						4K mode: 60 2K mode: 48	
	848 x 480	59.94	✓	✓						60	
	1024 x 768	60	✓	✓						60	
	1024 x 768	75	✓	✓						60	
	1024 x 768	85	✓	✓						60	
	1280 x 720	47.95	✓	✓						4K mode: 60 2K mode: 48	
	1280 x 768	60	✓	✓						60	
	1280 x 800	60	✓	✓						60	
	1280 x 960	60	✓	✓						60	
	1280 x 1024	60.02	✓	✓						60	
	1280 x 1024	75.02	✓	✓						60	
	1280 x 1024	85.02	✓	✓						60	
	1366 x 768	60	✓	✓						60	
	1440 x 900	60	✓	✓						60	
	1400 x 1050	60	✓	✓						60	
	1600 x 1200	60	✓	✓						60	
	1680 x 1050	59.94	✓	✓						60	
	1920 x 1080	47.95	✓	✓						4K mode: 60 2K mode: 48	
	1920 x 1200 RB	50	✓	✓					✓	50	
	1920 x 1200 RB	60	✓	✓					✓	60	
	1920 x 1080	100	✓	✓ *4						100	
	1920 x 1080	120	✓	✓ *4						120	
	1920 x 1200 RB	100	✓	✓ *4						100	
	1920 x 1200 RB	120	✓	✓ *4						120	

Notes

 *1 HDBaseT supports 4K 24/25/30Hz 4:2:2 only

 *2 HDBaseT supports 4K 50/60Hz 4:2:0 only

 *3 HDMI 1,2 support up to 4:2:2, HDBaseT does not support

 *4 HDMI 1,2 support but HDBaseT does not support

Signal Format	Resolution	Frame Rate (Hz)	Display Port	HDMI 1/2 & HDBaseT			HD/SDI/3G	HDMI3/4		Output Frame Rate (Hz)
				RGB	YUV 8-bit	YUV 10-bit		YUV 12-bit	RGB	
PC	1600x1200	120	✓	✓*4						120
	2560 x 1600	100	✓	✓*4						100
	2560 x 1600	120	✓	✓*4						120
	2712 x 1528	50	✓	✓						50
	2712 x 1528	60	✓	✓						60
Apple Mac	640 x 480	66.59	✓	✓						60
	832 x 624	74.54	✓	✓						60
SDTV	480i	59.94								60
	1440x480i	60		✓	✓	✓	✓			60
	1440x576i	50		✓	✓	✓	✓			50
	576i	50								50
EDTV	480p	59.94	✓	✓	✓	✓	✓	✓	✓	60
	576p	50	✓	✓	✓	✓	✓	✓	✓	50

Notes

Signal Format	Resolution	Frame Rate (Hz)	Display Port	HDMI 1/2 & HDBaseT			HD/SDI/3G	HDMI3/4		Output Frame Rate (Hz)
				RGB	YUV 8-bit	YUV 10-bit		YUV 12-bit	RGB	
HDTV	1035i	60	✓	✓	✓	✓	✓			60
	1080i	50	✓	✓	✓	✓	✓			50
	1080i	59.94	✓	✓	✓	✓	✓			60
	1080i	60	✓	✓	✓	✓	✓			60
	720p	50	✓	✓	✓	✓	✓	✓	✓	60
	720p	59.94	✓	✓	✓	✓	✓	✓	✓	60
	720p	60	✓	✓	✓	✓	✓	✓	✓	60
	1080p	23.98	✓	✓	✓	✓	✓			4K mode: 60 2K mode: 48
	1080p	24	✓	✓	✓	✓	✓			4K mode: 60 2K mode: 48
	1080p	25	✓	✓	✓	✓	✓			60
	1080p	29.97	✓	✓	✓	✓	✓			60
	1080p	30	✓	✓	✓	✓	✓			60
	1080p	50	✓	✓	✓	✓	✓	✓	✓	50
	1080p	59.94	✓	✓	✓	✓	✓	✓	✓	60
	1080p	60	✓	✓	✓	✓	✓	✓	✓	60
	2K (2048x1080)	24	✓	✓	✓	✓	✓			4K mode: 60 2K mode: 48
	2K (2048x1080)	25	✓	✓	✓	✓	✓			50
	2K (2048x1080)	30	✓	✓	✓	✓	✓			60
	2K (2048x1080)	50	✓	✓	✓	✓	✓			50
	2K (2048x1080)	60	✓	✓	✓	✓	✓			60
	4K-UHD (3840x2160)	24	✓	✓	✓	✓*1	✓*1			4K mode: 60 2K mode: 48
	4K-UHD (3840x2160)	25	✓	✓	✓	✓*1	✓*1			50
	4K-UHD (3840x2160)	30	✓	✓	✓	✓*1	✓*1			60
	4K-UHD (3840x2160)	50	✓	✓	✓	✓*2	✓*3	✓*3		50
4K-UHD (3840x2160)	60	✓	✓	✓	✓*2	✓*3	✓*3		60	

Notes

3D formats

Standard		Resolution	V-Freq (Hz)	V-Total	H Freq. (kHz)	Output Frame Rate (Hz)	HDMI3/4	Dual-pipe HDMI 3 / 4	Remarks
1080p100	Frame Sequential	1920x1080	100	1125	112.5	100	✓		Maintained aspect ratio in 16:9
1080p120	Frame Sequential	1920x1080	120	1125	135	120	✓		Maintained aspect ratio in 16:9
WUXGA_100_RB	Frame Sequential	1920x1200	100	1258	125.72	100	✓		Maintained aspect ratio in 16:10
1080p50	Dual Pipe	1920x1080	50	1125	56.25	100		✓	Maintained aspect ratio in 16:9
1080p60	Dual Pipe	1920x1080	60	1125	67.5	120		✓	Maintained aspect ratio in 16:9
WUXGA_50_RB	Dual Pipe	1920x1200	50	1258	62.86	100		✓	Maintained aspect ratio in 16:10
WUXGA_60_RB	Dual Pipe	1920x1200	60	1125	74.04	120		✓	Maintained aspect ratio in 16:10
WQXGA_60_RB	Dual Pipe	2560x1600	60	1646	98.71	120		✓	Maintained aspect ratio in 16:10
WQXGA+60	Dual Pipe	2712x1528	60	1592	95.49	120		✓	Maintained aspect ratio in 16:10

Notes

For HDMI 3 and 4 Dual-Pipe 3D, HDMI 3 is the Left eye source and HDMI 4 is the Right Eye source.

SDI formats

Timing	SDI Link Mode	Signal Standards	Color Encode	Sampling Structure	Bit Depth
NTSC	SD	SMPTE 259M-C 270Mbps SD	YCbCr	4:2:2	10
PAL	SD	SMPTE 259M-C 270Mbps SD	YCbCr	4:2:2	10
1035i60	HD	SMPTE 292M 1.5Gbps HD	YCbCr	4:2:2	10
1080i59	HD	SMPTE 292M 1.5Gbps HD	YCbCr	4:2:2	10
1080i60	HD	SMPTE 292M 1.5Gbps HD	YCbCr	4:2:2	10
1080P30	HD	SMPTE 292M 1.5Gbps HD	YCbCr	4:2:2	10
1080P25	HD	SMPTE 292M 1.5Gbps HD	YCbCr	4:2:2	10
1080i50	HD	SMPTE 292M 1.5Gbps HD	YCbCr	4:2:2	10
1080P24	HD	SMPTE 292M 1.5Gbps HD	YCbCr	4:2:2	10
720P60	HD	SMPTE 292M 1.5Gbps HD	YCbCr	4:2:2	10
720P50	HD	SMPTE 292M 1.5Gbps HD	YCbCr	4:2:2	10
1080Sf25	HD	SMPTE 292M 1.5Gbps HD	YCbCr	4:2:2	10
1080Sf30	HD	SMPTE 292M 1.5Gbps HD	YCbCr	4:2:2	10
1080P50	3G Level A	SMPTE 424M 3Gbps	YCbCr	4:2:2	10
1080P59	3G Level A	SMPTE 424M 3Gbps	YCbCr	4:2:2	10
1080P60	3G Level A	SMPTE 424M 3Gbps	YCbCr	4:2:2	10
1080P50	3G Level B	SMPTE 424M 3Gbps	YCbCr	4:2:2	10
1080P59	3G Level B	SMPTE 424M 3Gbps	YCbCr	4:2:2	10
1080P60	3G Level B	SMPTE 424M 3Gbps	YCbCr	4:2:2	10

Notes

Appendix B: wiring details

Signal inputs and outputs

HDMI 1 and 2

19 way type A connector

1. TMDS Data 2+
2. TMDS Data 2 Shield
3. TMDS Data 2-
4. TMDS Data 1+
5. TMDS Data 1 Shield
6. TMDS Data 1-
7. TMDS Data 0+
8. TMDS Data 0 Shield
9. TMDS Data 0-
10. TMDS Clock+
11. TMDS Clock Shield
12. TMDS Clock-
13. CEC
14. not connected
15. SCL (DDC Clock)
16. SCA (DDC Data)
17. DDC/CEC Ground
18. +5 V Power
19. Hot Plug Detect

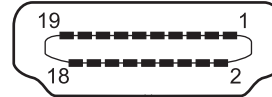

HDMI: pin view of panel connector

Notes

DisplayPort

DisplayPort 1.2

Pin 1	ML_Lane 0 (p)	Lane 0 (positive)
Pin 2	GND	Ground
Pin 3	ML_Lane 0 (n)	Lane 0 (negative)
Pin 4	ML_Lane 1 (p)	Lane 1 (positive)
Pin 5	GND	Ground
Pin 6	ML_Lane 1 (n)	Lane 1 (negative)
Pin 7	ML_Lane 2 (p)	Lane 2 (positive)
Pin 8	GND	Ground
Pin 9	ML_Lane 2 (n)	Lane 2 (negative)
Pin 10	ML_Lane 3 (p)	Lane 3 (positive)
Pin 11	GND	Ground
Pin 12	ML_Lane 3 (n)	Lane 3 (negative)
Pin 13	CONFIG1	Connected to Ground1
Pin 14	CONFIG2	Connected to Ground1
Pin 15	AUX CH (p)	Auxiliary Channel (positive)
Pin 16	GND	Ground
Pin 17	AUX CH (n)	Auxiliary Channel (negative)
Pin 18	Hot Plug	Hot Plug Detect
Pin 19	Return	Return for Power
Pin 20	DP_PWR	Power for connector (3.3 V 500 mA)

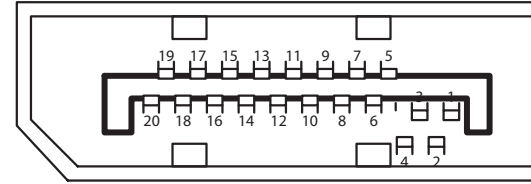

DisplayPort: pin view of panel connector

Notes

3G-SDI in, 3G-SDI out

75 ohm BNC



3G-SDI connector

HDBaseT input

RJ45 socket.

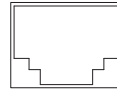

HDBaseT / LAN

Notes

Control connections

LAN

RJ45 socket (Shared with HDBaseT)

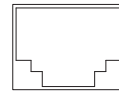

HDBaseT / LAN

RS232

9 way D-type connector

1. unused
2. Transmitted Data (TX)
3. Received Data (RX)
4. unused
5. Signal Ground
6. unused
7. unused
8. unused
9. unused

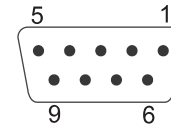

RS232
pin view of female connector

IR input

3.5 mm mini jack

Tip Signal

Ring Not connected

Sleeve Ground

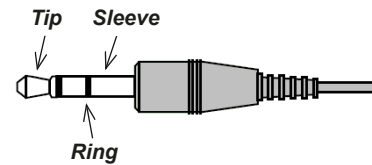

Notes

 Only one remote connection (RS232 or LAN) should be used at any one time.

Appendix C: glossary of terms*Notes***1**

1080p

An HDTV resolution which corresponds to 1920 x 1080 pixels (a widescreen aspect ratio of 16:9).

3

3D active glasses

Wireless battery-powered glasses with LCD shutters. Synchronization information is communicated to the glasses by means of an infrared (IR) or radio frequency (RF) emitter which is connected to the Sync Out terminal on the projector. IR or RF pulses are transmitted by the emitter to signal when the left eye and right eye images are being displayed. The glasses incorporate a sensor which detects the emitter's signal and synchronises the left and right eye shutters with the projected image.

3D passive glasses

Passive glasses do not require a power source to work. Light with left-hand polarisation can pass through the left lens and light with right hand polarisation can pass through the right-hand lens. These glasses are used in conjunction with another device which polarizes the image, such as a ZScreen.

A

Adjust lines

A pattern applied to the image where its edge is to be blended with another image. Adjust lines are used to position the projectors in the array during the edge blend process.

Anamorphic lens

A special lens which, when used with the TheaterScope aspect ratio, allows watching 2.35:1 content packed in a 16:9 source.

Aperture

The opening of the lens that determines the angle through which light travels to come into focus.

Aspect ratio

The proportional relationship between the width and the height of the projected image. It is represented by two numbers separated by a colon, indicating the ratio of image width and height respectively: for example, 16:9 or 2.35:1. Not to be confused with resolution.

B**Blanking (projection)**

The ability to intentionally turn off, that is, set to black, areas around the edges of the projected image. It is sometimes referred to as “curtains” since it can be used to blank an area of image that literally falls on the curtains at the side of the screen in a movie theater. Usually no image resizing or geometric correction takes place and the “blanked” part of the image is lost. Not to be confused with horizontal and vertical blanking (video signal).

Blanking (video signal)

The section of the video signal where there is no active video data. Not to be confused with blanking (projection).

Blend region

The area of the image that is to overlap with another image in an edge blend setup. Sometimes called overlapping region.

Brightness (electronic control)

A control which adds a fixed intensity value to every pixel in the display, moving the entire range of displayed intensities up or down, and is used to set the black point in the image (see Contrast). In Component Video signals, brightness is the same as luminance.

Brightness (optical)

Describes how ‘bright’ an image that is projected onto a screen appears to an observer.

C**C**

Also known as ‘C’, this is the component, or pair of components, of a Component Video signal which describes color difference information.

Chrominance

Also known as ‘C’, this is the component, or pair of components, of a Component Video signal which describes color difference information.

Color difference

In Component Video signals, the difference between specified colors and the luminance component. Color difference is zero for monochrome images.

Color gamut

The spectrum of color available to be displayed.

Color temperature

The position along the black body curve on the chromaticity diagram, normally quoted in Kelvin. It takes into account the preset values for color balance in the service set-up to take up the variations in the prism. The projector allows you to adjust this temperature (i.e. adjust the picture color temperature).

Component video

A three-wire or four-wire video interface that carries the signal split into its basic RGB components or luminance (brightness) and two-color difference signals (YUV) and synchronization signals.

Notes

Contrast (electronic control)

The adjustment of the white point of the image without affecting the black point. This increases the intensity range of the displayed image.

Contrast (optical)

The intensity difference between the darkest and lightest areas of the screen.

Cr, Cb

Color difference signals used with 'Y' for digital Component Video inputs. They provide information about the signal color. Not to be confused with Pr, Pb.

Crop

Remove part of the projected image. Alternatively, fit an image into a frame with a different aspect ratio by removing part of the image. The image is resized so that either its length or its width equals the length or width of the frame, while the other dimension has moved outside the frame; the excess area is then cut out.

D

Dark time

The time inserted between frames when using 3D active glasses, to avoid ghosting caused by switching time between left and right eye.

DDC (Display Data Channel)

A communications link between the source and projector. DDC is used on the HDMI, DVI and VGA inputs. The link is used by the source to read the EDID stored in the projector.

Deinterlacing

The process of converting interlaced video signals into progressive ones.

DHCP (Dynamic Host Configuration Protocol)

A network protocol that is used to configure network devices so that they can communicate on an IP network, for example by allocating an IP address.

DMD™ (Digital Micromirror Device™)

The optical tool that transforms the electronic signal from the input source into an optical image projected on the screen. The DMD™ of a projector has a fixed resolution, which affects the aspect ratio of the projected image. A Digital Micromirror Device™ (DMD™) consists of moving microscopic mirrors. Each mirror, which acts as a pixel, is suspended between two posts by a thin torsion hinge. It can be tilted to produce either a bright or dark pixel.

E

Edge blend

A method of creating a combined image by blending the adjoining edges of two or more individual images.

Edge tear

An artifact observed in interlaced video where the screen appears to be split horizontally. Edge tears appear when the video feed is out of sync with the refresh rate of the display device.

EDID (Extended Display Identification Data)

Information stored in the projector that can be read by the source. EDID is used on the HDMI, DVI and VGA inputs, allowing the source to automatically configure to the optimum display settings.

EDTV (Enhanced Definition Television)

A progressive digital television system with a lower resolution than HDTV.

F**Field**

In interlaced video, a part of the image frame that is scanned separately. A field is a collection of either all the odd lines or all the even lines within the frame.

Frame

One of the many still images displayed in a sequence to create a moving picture. A frame is made of horizontal lines of pixels. For example, a 1920x1080 frame consists of 1080 lines, each containing 1920 pixels. In analog video frames are scanned one at a time (progressive scanning) or split into fields for each field to be scanned separately (interlaced video).

Frame rate

The number of frames shown per second (fps). In TV and video, a frame rate is the rate at which the display device scans the screen to “draw” the frame.

Frame rate multiplication

To stop low frame rate 3D images from flickering, frame rate multiplication can be used, which increases the displayed frame rate by two or three times

G**Gamma**

A nonlinear operation used to code and decode luminance. It originates from the Cathode Ray Tube technology used in legacy television sets.

Ghosting

An artifact in 3D image viewing. Ghosting occurs when an image intended for one eye is partially seen by the other eye. Ghosting can be removed by optimizing the dark time and sync delay.

Notes

H

HDCP (High-bandwidth Digital Content Protection)

An encryption scheme used to protect video content.

HDTV (High Definition Television)

A television system with a higher resolution than SDTV and EDTV. It can be transmitted in various formats, notably 1080p and 720p.

Hertz (Hz)

Cycles per second.

Horizontal Scan Rate

The rate at which the lines of the incoming signal are refreshed. The rate is set by the horizontal synchronization from the source and measured in Hertz.

Hs + Vs

Horizontal and vertical synchronization.

Hue

The graduation (red/green balance) of color (applicable to NTSC).

I

Interlacing

A method of updating the image. The screen is divided in two fields, one containing every odd horizontal line, the other one containing the even lines. The fields are then alternately updated. In analog TV interlacing was commonly used as a way of doubling the refresh rate without consuming extra bandwidth.

Interleaving

The alternation between left and right eye images when displaying 3D.

L

LED (Light Emitting Diode)

An electronic component that emits light.

Letterboxing

Black margins at the top and bottom of the image. Letterboxing appears when a wider image is packed into a narrower frame without changing the original aspect ratio.

Lumen

A photometric unit of radiant power. For projectors, it is normally used to specify the total amount of emitted visible light.

Notes

Luminance

Also known as 'Y', this is the part of a Component Video signal which affects the brightness, i.e. the black and white part.

N

Noise

Electrical interference displayed on the screen.

NTSC (National Television Standards Committee)

The United States standard for television - 525 lines transmitted at 60 interlaced fields per second

O

OSD (on-screen display)

The projector menus allowing you to adjust various settings.

Overlapping region

The area of the image that is to overlap with another image in an edge blend setup. Sometimes called overlapping region.

P

PAL (Phase Alternate Line)

The television system used in the UK, Australia and other countries - 625 lines transmitted at 50 interlaced fields per second.

Pillarboxing

Black margins at the left and right of the image. Pillarboxing appears when a narrower image is packed into a wider frame without changing the aspect ratio.

Pixel

Short for Picture Element. The most basic unit of an image. Pixels are arranged in lines and columns. Each pixel corresponds to a micromirror within the DMD™; resolutions reflect the number of pixels per line by the number of lines. For example, a 1080p projector contains 1080 lines, each consisting of 1920 pixels.

Pond of mirrors

Area around the periphery of the DMD™ containing inactive mirrors. The pond of mirrors may cause artifacts, for example during the edge blending process.

Pr, Pb

Color difference signals used with 'Y' for analog Component Video inputs. They provide information about the signal color. Not to be confused with Cr, Cb.

Notes

Primary colors

Three colors any two of which cannot be mixed to produce the third. In additive color television systems the primary colors are red, green and blue.

Progressive scanning

A method of updating the image in which the lines of each frame are drawn in a sequence, without interlacing.

Pulldown

The process of converting a 24 fps film footage to a video frame rate (25 fps for PAL/SECAM, 30 fps for NTSC) by adding extra frames. DP projectors automatically carry out reverse pulldown whenever possible.

R**Resolution**

The number of pixels in an image, usually represented by the number of pixels per line and the number of lines (for example, 1920 x 1200).

RGB (Red, Green and Blue)

An uncompressed Component Video standard.

S**Saturation**

The amount of color in an image.

Scope

An aspect ratio of 2.35:1.

SDTV (Standard Definition Television)

An interlaced television system with a lower resolution than HDTV. For PAL and SECAM signals, the resolution is 576i; for NTSC it is 480i.

SECAM (Sequential Color with Memory)

The television system used in France, Russia and some other countries - 625 lines transmitted at 50 interlaced fields per second.

Smooth picture

A feature that can display a higher resolution source than the native resolution of the projector without losing any pixel data.

SX+

A display resolution of 1400 x 1050 pixels with a 4:3 screen aspect ratio. (Shortened from SXGA+, stands for Super Extended Graphics Array Plus.)

Synchronization

A timing signal used to coordinate an action.

T

Test pattern

A still image specially prepared for testing a projection system. It may contain various combinations of colors, lines and geometric shapes.

TheaterScope

An aspect ratio used in conjunction with a special anamorphic lens to display 2.35:1 images packed into a 16:9 frame.

Throw distance

The distance between the screen and the projector.

Throw ratio

The ratio of the throw distance to the screen width.

TRC (Throw ratio correction)

A special number used in calculating throw distances and throw ratios when the image does not fill the width of the DMD™. TRC is the ratio of the DMD™ aspect ratio to the image source aspect ratio: $TRC = \text{DMD}^{\text{TM}} \text{ aspect ratio} / \text{Source aspect ratio}$ TRC is only used in calculations if it is greater than 1.

U

UXGA

A display resolution of 1600 x 1200 pixels with a 4:3 screen aspect ratio. (Stands for Ultra Extended Graphics Array.)

V

Vertical Scan Rate

The rate at which the frames of the incoming signal are refreshed. The rate is set by the vertical synchronization from the source and measured in Hertz.

Vignetting

Optical cropping of the image caused by the components in the projection lens. This can happen if too much offset is applied when positioning the image using the lens mount.

Vista

An aspect ratio of 1.66:1.

W

WUXGA

A display resolution of 1920 x 1200 pixels with a 16:10 screen aspect ratio. (Stands for Widescreen Ultra Extended Graphics Array.)

Notes

Y

Y

This is the luminance input (brightness) from a Component Video signal.

YUV

Color difference signals used with 'Y' for analog Component Video inputs. They provide information about the signal color. Not to be confused with Cr, Cb.

Z

ZScreen

A special kind of light modulator which polarizes the projected image for 3D viewing. It normally requires that images are projected onto a silver screen. The ZScreen is placed between the projector lens and screen. It changes the polarization of the projected light and switches between left- and right-handed circularly polarized light at the field rate.

Notes

DIGITAL PROJECTION

A Delta Associate Company

Contact Information:

Digital Projection Limited

Greenside Way, Middleton,
Manchester, M24 1XX, UK

Registered in England No.
2207264

Registered Office: As Above

Tel: (+44) 161 947 3300
Fax: (+44) 161 684 7674

enquiries@digitalprojection.co.uk
service@digitalprojection.co.uk

www.digitalprojection.co.uk

Digital Projection Inc.

55 Chastain Road, Suite 115,
Kennesaw, GA 30144, USA

Tel: (+1) 770 420 1350
Fax: (+1) 770 420 1360

powerinfo@digitalprojection.com

www.digitalprojection.com

Digital Projection China

中国 北京市朝阳区 芍药居北
里 101号 世奥国际中心 A座 2301
室 (100029)

Rm A2301, ShaoYaoJu 101 North
Lane, Shi Ao International Center,
Chaoyang District, Beijing 100029,
PR CHINA

Tel: (+86) 10 84888566
Fax: (+86) 10 84888566-805

techsupport@dp-china.com.cn

www.dp-china.com.cn

Digital Projection Asia

16 New Industrial Road, #02-10
Hudson Technocentre, Singapore
536204

Tel: (+65) 6284-1138
Fax: (+65) 6284-1238

www.digitalprojectionasia.com

Digital Projection Japan

〒105-0012 東京都港区芝大門
2-1-14

2-1-14 Shibadaimon, Minato-ku,
Tokyo, Japan 105-0012

japan@digitalprojection.co.uk

www.digitalprojection.com/jp

Digital Projection Taiwan

186 Ruey Kuang Rd, Neihu
District, Taipei, 114 Taiwan

Tel: +886-8797-2088 x8854

Taiwan@digitalprojection.co.uk

Digital Projection Korea

1511, Byucksan Digital Valley 6-
cha, Gasan-dong, Geumcheon-
gu, Seoul, Korea

Tel: (+82) 2 515 5303 #1417

Korea@digitalprojection.co.uk

Digital Projection FZE

Unit B4, Light Industrial Units 4,
Silicon Oasis, Dubai, UAE

Tel: +971 43300800

enquiries@digitalprojection.co.uk

www.digitalprojection.com

Digital Projection India

india@digitalprojection.co.uk