

DIGITAL **PROJECTION**

A Delta Associate Company

Titan Laser WUXGA

High Brightness Digital Video Projector

INSTALLATION & QUICK START GUIDE

CONNECTION GUIDE

OPERATING GUIDE

REFERENCE GUIDE



About this document

Follow the instructions in this manual carefully to ensure safe and long-lasting use of the projector.

Symbols used in this document

Many pages in this document have a dedicated area for notes. The information in that area is accompanied by the following symbols:



WARNING: this symbol indicates that there is a danger of physical injury to yourself and/or damage to the equipment unless the instructions are closely followed.



ELECTRICAL WARNING: this symbol indicates that there is a danger of electrical shock unless the instructions are closely followed.



LASER WARNING: this symbol indicates that there is a potential hazard of eye exposure to laser radiation unless the instructions are closely followed.



NOTE: this symbol indicates that there is some important information that you should read.

Product revision

Because we at Digital Projection continually strive to improve our products, we may change specifications and designs, and add new features without prior notice.

Updates may be available online. Please visit the Digital Projection website for all latest documents.

Legal notice

Trademarks and trade names mentioned in this document remain the property of their respective owners. Digital Projection disclaims any proprietary interest in trademarks and trade names other than its own.

Copyright © 2019 Digital Projection Ltd. All rights reserved.

Notes

Laser information

Caution - use of controls or adjustments or performance of procedures other than those specified herein may result in hazardous radiation exposure.

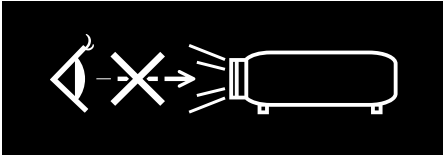
Optical radiation

Caution - possibly hazardous optical radiation emitted from this product. Do not stare at operating light source. May be harmful to eyes. This projector is tested according to IEC/EN62471-5:2015 (Photobiological safety of lamps and lamp systems – Part 5: Image projectors standard) and is Risk Group 3 (high risk).

Notes

Light Hazard Warning

The hazard distance is the distance measured from the projection lens at which the intensity or energy per unit of surface is lower than the applicable exposure limit on the cornea or skin. If the person is within the hazard distance, the beam is considered unsafe for exposure.

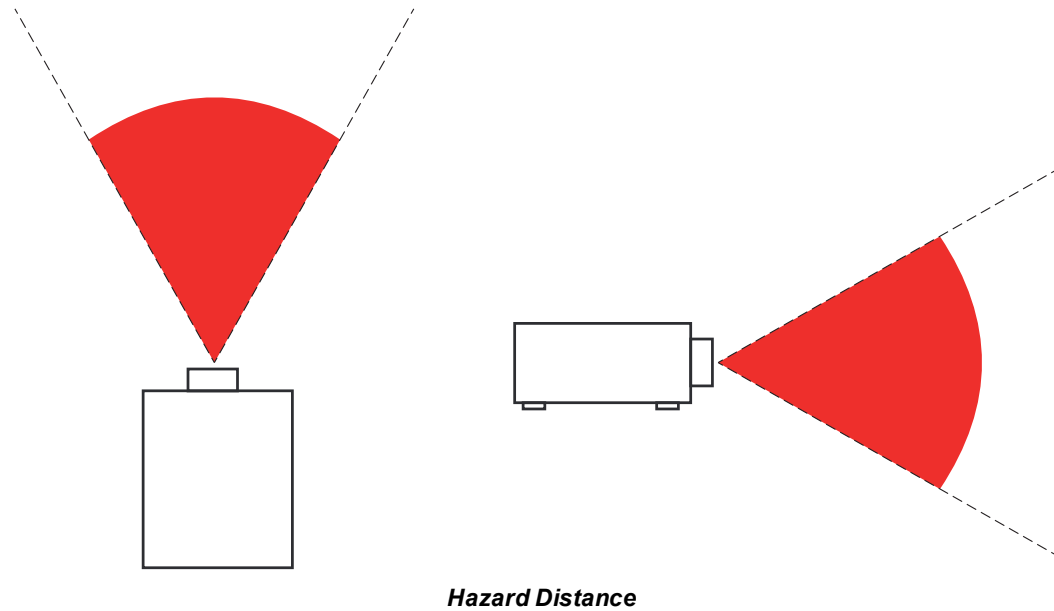

Notes



No direct exposure to the beam is permitted, RG3 IEC 62471-5:2015.



Operators should control access to the beam within the hazard distance or install the projector at sufficient height to prevent exposures of spectators' eyes within the hazard distance.

Light Hazard Distances

LENS	HAZARD DISTANCE
0.67 : 1 Super Wide fixed	2m
1.12 : 1 Wide Fixed	3.5m
1.16-1.49:1 Super Wide Zoom	5.5m
1.39 - 1.87:1 Wide Zoom	6.5m
1.87 - 2.56:1 Standard Zoom	8.5m
2.56 - 4.16:1 Semi Long Zoom	10.5m
4.16 - 6.96:1 Long Zoom1	14m
6.92 - 10.36:1 Long Zoom2	

Introduction

This manual describes both the Titan Laser 37000 WU Series and Titan Laser 29000 WU.

Congratulations on your purchase of this Digital Projection product. Your projector has the following key features:

- WUXGA projector.
- Support for Frame Sequential and Dual Pipe 3D formats.
- HDBaseT® for transmission of uncompressed High Definition Video up to 100 m from the source.
- 3G-SDI with loop-through.
- Edge Blend with black level correction.
- Blanking control for custom input window sizing.
- Cornerstone, Vertical & Horizontal Keystone, Pincushion & Barrel, and Image Rotation.
- Control via LAN and RS232.
- Motorised lens mount.
- Separate control of screen and source aspect ratio.
- Non-linear warp for irregular projection surfaces.

A serial number is located on the side of the projector. Record it here:

Notes

Contents**Notes**

About this document	2	Fitting a lens hood	27
Symbols used in this document	2	Fitting a lens stabilizing bracket	28
Product revision	2	Operating the projector	32
Legal notice	2	Switching the projector on	32
Laser information	3	Switching the projector off	32
Optical radiation	3	Selecting an input signal	32
Light Hazard Warning	4	Selecting a test pattern	32
Light Hazard Distances	4	Adjusting the lens	33
Introduction	5	Lens menu	33
Contents	6	Remote control	33
What's in the box?	12	Adjusting the image	33
Connecting the power supply	13	Orientation	33
Projector overview	14	Geometry	33
Control panel	15	Picture	33
Remote control	17	Signal inputs	36
Infrared reception	20	Digital inputs and outputs	36
Positioning the screen and projector	21	EDID on the DisplayPort, HDMI, and HDBaseT inputs	37
Roll and pitch	22	Using DisplayPort/ HDMI/ HDBaseT switchers with the projector	37
Stacking and rigging	23	3D connections	38
Pin and cup stacking	23	Frame sequential 1080p 3D up to 120Hz and WUXGA 3D at 100Hz	38
Using the eye bolts	24	Dual Pipe 1080p and WUXGA 3D sources at up to 100 and 120Hz	38
Point-to point connections	24	3D Sync	39
Threaded suspension cables	25	Control connections	40
Changing the lens	26	LAN connection examples	41
Inserting a new lens	26	RS232 connection example	42
Removing the lens	26	Using the menus	44

Opening the Menu	44	Overscan	62
Opening a submenu	44	Blanking	63
Exiting menus and closing the OSD	45	Keystone	64
Inside a menu	45	Keystone example	65
Accessing sub menus	46	Keystone settings	66
Executing commands	46	4 corners	67
Editing projector settings	47	Top right corner example	68
Using a slider to set a value	47	Rotation	69
Editing numeric values	48	Rotation example	70
Using the projector	49	Pincushion / barrel	71
Main menu	49	Pincushion/ Barrel example	71
Lens menu	50	Arc	72
Lens control	50	Custom warp	73
Lens memory	51	Edge blend menu	74
Image menu	52	Blend start	75
Color menu	54	Blend width	76
Color space	54	Black level uplift	77
Color mode	55	3D menu	78
ColorMax	55	3D types	79
Manual color matching	56	Some 3D settings explained	80
Color matching parameters explained	57	Dark time	80
Color temperature	58	Eye swap	80
Gains and lifts	58	Sync offset	81
Geometry menu	59	Laser menu	82
Aspect ratio	59	Setup menu	83
Theaterscope setting	60	ColorMax	85
Digital zoom	61	Measured data/ target data	86

Notes

		Notes
Power on / off	87	
Clock adjust	88	
PIC mute setting	88	
OSD settings	89	
Memory	89	
EDID Mode	90	
Hotkey setting	90	
Network menu	91	
Network setup	92	
Art-net setup	92	
Art-net channel setting	93	
PIP menu	94	
Information menu	95	
Signal format	95	
System status	96	
Thermal status	96	
Factory reset	97	
Served web pages	98	
Choosing a lens	108	
Basic calculation	109	
Basic calculation example	110	
Full lens calculation	111	
Introducing TRC	111	
Calculating TRC	112	
TRC table	112	
Calculating the throw ratio with TRC	112	
Full lens calculation example	113	
Screen requirements	114	
Fitting the image to the display	114	
WUXGA images displayed full width	114	
WUXGA images displayed with a height of 1200 pixels	114	
WUXGA images displayed full height	115	
Diagonal screen sizes	115	
Positioning the image	116	
Aspect ratios explained	118	
Aspect ratios examples	118	
Source: 4:3	118	
Source: 16:9	119	
Source: 16:10 (native)	119	
Aspect ratio example: TheatreScope	120	
Appendix A: supported signal input modes	121	
2D formats	121	
3D formats	124	
SDI formats	125	
Appendix B: wiring details	126	
Signal inputs and outputs	126	
HDMI 1 and 2	126	
DisplayPort	127	
3G-SDI in, 3G-SDI out	128	
HDBaseT input	128	
Control connections	129	
LAN	129	
RS232	129	
IR input	129	

Appendix C: memory scheme and memory items 130
Appendix D: glossary of terms133

Notes

This page is intentionally left blank

DIGITAL **PROJECTION**

A Delta Associate Company

***Titan Laser* WUXGA**

High Brightness Digital Video Projector

INSTALLATION & QUICK START GUIDE



What's in the box?

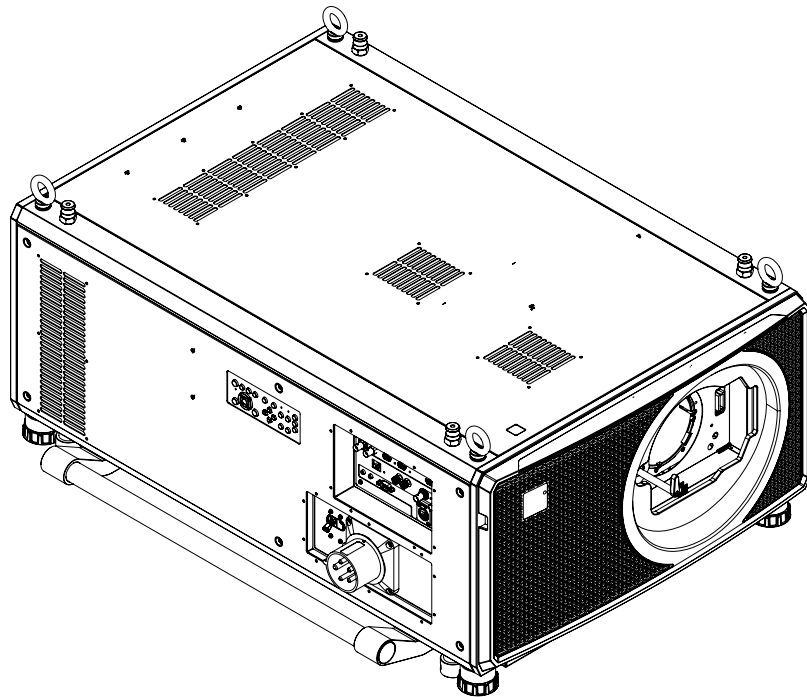

Projector

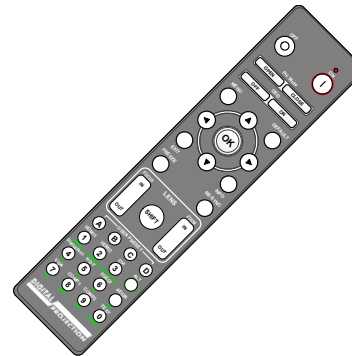

Remote Control

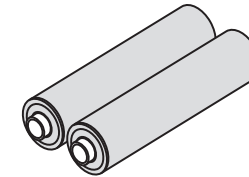

Batteries

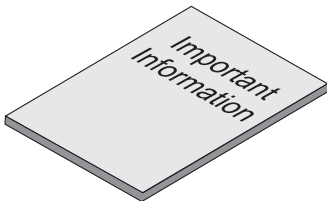

Important Information Book



Lens Stabilizing Bracket

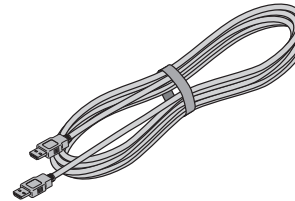

HDMI Cable

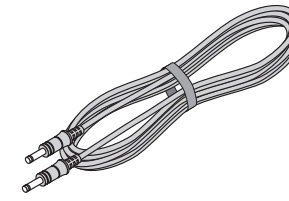

Remote Control Cable







Power Cable, UK / RoW



Power Cable, USA only

Notes

-  *Make sure your box contains everything listed. If any pieces are missing, contact your dealer.*
-  *Only one remote is supplied with the projector.*
-  *Save and store the original box and packing materials, in case you ever need to ship your projector.*
-  *The projector is shipped without a lens.*
-  *Only the appropriate cable for destination territory is supplied with the projector*

Connecting the power supply

Rest of the World:

1. Firmly push the mains connector into the socket
2. Rotate the connector 90° clockwise to lock it in place

USA Only

1. Firmly push the mains connector into the socket **2**
2. Rotate the connector 90° clockwise to lock it in place

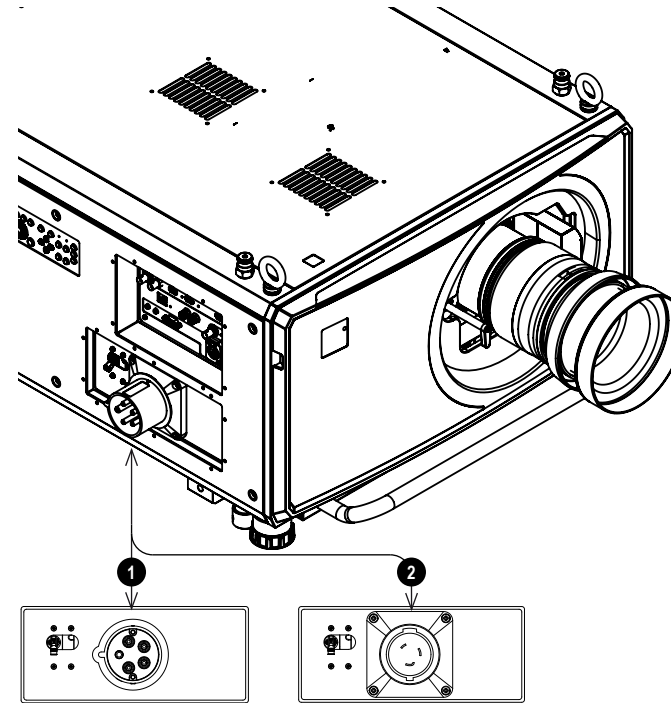



Notes

 Use only the power cable provided.

 Ensure that the power outlet includes a ground connection as this equipment **MUST** be earthed.

 Handle the power cable carefully and avoid sharp bends. Do not use a damaged power cable.

 The USA model can operate at 110V or 200V. Voltage selection is automatic, but the projector must be powered off before switching power outlets.

 Light output power is reduced to approx 30% when using the USA model and operating on 110V.

Projector overview

1. Eye bolts
2. Connections panel
3. Stacking pins (x4)
4. Adjustable feet (x4)
5. Stacking cups (x4)
6. Control panel
7. Mains socket and switch

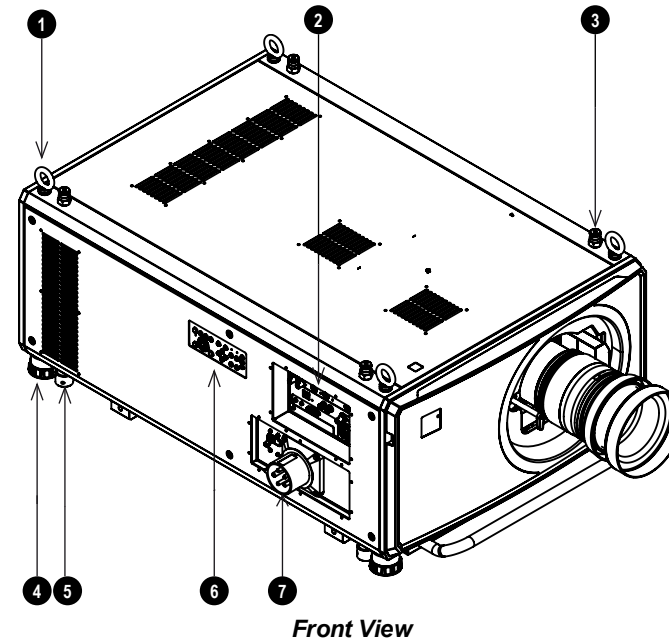

Notes

Control panel

1. POWER

Switches the projector on and off (STANDBY).

Indicator:

- Off. The projector is switched off
- Flashing green. The projector is warming up
- Flashing blue. The projector is cooling down
- On, red. Standby mode
- On, green. The projector is switched on.

2. INPUT

Switches to the next input source.

3. AUTO SYNC

Re-synchronises with the current input signal.

4. ASPECT

Changes the aspect ratio.

5. CENTER LENS

Centers the lens.

6. PIC MUTE

Switches the laser off/on or blanks the DMD.
Indicator:
Off = the projector is in standby
On, blue = the projector is on, normal projection
On, red = the projector is on, picture mute is activated

7. LIGHT INDICATOR

Off = light is switched off
Flashing red (cycles of single flashes) = failure to light up during power up
Flashing red (cycles of double flashes) = unexpected light off while running
On, green = light is switched on

8. TEMP INDICATOR

Off = no problem
Flashing red = temperature error

9. HOTKEYS

User selectable functions.

Pre-set functions:

HOTKEY 1 Information

HOTKEY 2 Test Pattern

HOTKEY 3 Lens Memory Load

Additional options: Picture Mode, Ambient Brightness Correction, Freeze, PIP Swap.

HOTKEY 3 is used when a lens adapter is installed. Whilst in standby mode, press and hold HOTKEY 3 for five seconds to run center lens before installing the lens.

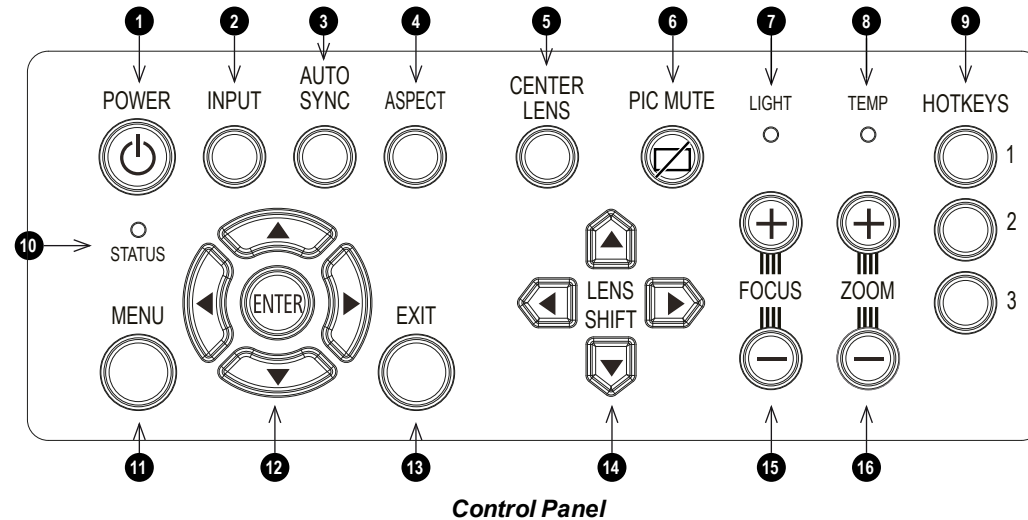

Notes



AUTO SYNC and ASPECT do not work when the projector uses HDMI 3 or 4.

10. **STATUS**
 - Off = no problem
 - Flashing red (continuously) = cover error
 - Flashing red (cycles of four flashes) = fan error
 - On, red = system error
11. **MENU**
 - Displays and exits the OSD.
12. **Arrow buttons & ENTER**
 - Navigation buttons used to highlight menu entries in the OSD. Press **ENTER** to open or execute the highlighted menu entry.
13. **EXIT**
 - Exits the current OSD page and enters the level above.
14. **LENS SHIFT**
 - Arrow buttons move the lens in the specified direction.
15. **FOCUS**
 - Plus and minus buttons move the focus in and out.
16. **ZOOM**
 - Plus and minus buttons zoom in and out.

Notes

Remote control

1. **Power ON / OFF**
Turns power on and off.
2. **Pic Mute OPEN / CLOSE**
Shows and hides the projected image.
There are two PIC Mute settings:
 - Laser. When off, the laser is switched off and no image is projected
 - DMD Blanking. When off, the laser remains on and a black image is projected
3. **OSD ON / OFF**
Enable and disable screen timeout messages and control whether to show the OSD during projection.
4. **MENU**
Access the OSD. If the OSD is open, press this button to go back to the previous menu.
5. **Navigation (arrows and OK)**
Navigate through the menus with the arrows, confirm your choice with **OK**.
In lens adjustment modes, the arrows are used to move, zoom or focus the lens.
See **11** below. In lens adjustment modes, or when the OSD is not showing, the OK button switches between modes: **Shift Adjustment** and **Zoom / Focus Adjustment**.
6. **EXIT**
Go up one level in the OSD. When the top level is reached, press to close the OSD.
7. **FREEZE**
Freeze the current frame.
8. **DEFAULT**
When editing a parameter, press this button to restore the default value.
9. **INFO**
Access information about the projector.
10. **RE-SYNC**
Re-synchronise with the current input signal

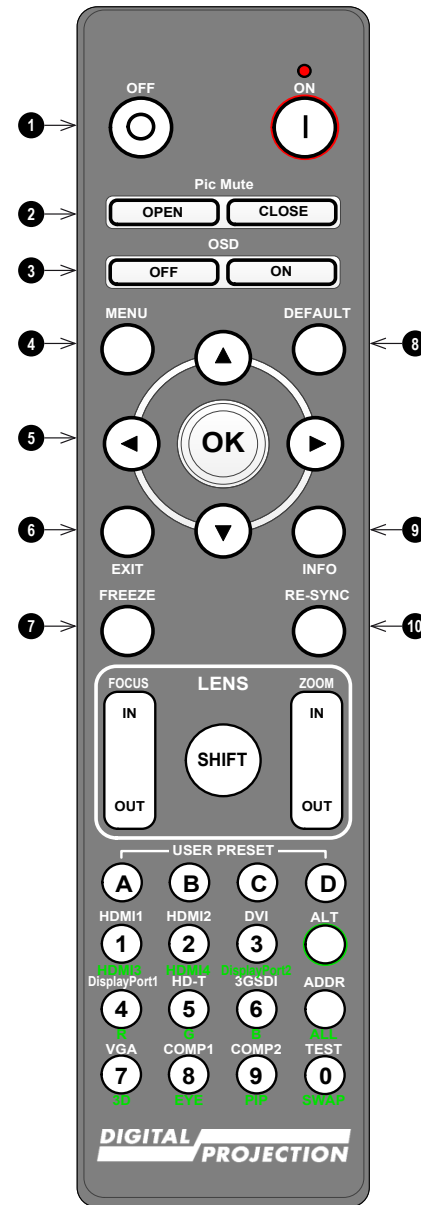

Remote Control

Notes

 The PIC Mute setting is defined in the setup menu. See Setup menu on page 83

 FREEZE and RE-SYNC are not available when the projector uses input HDMI 3 or 4.

11. **LENS adjustment**

- **FOCUS IN / OUT:** adjust focus.
- **SHIFT:** press and hold this button, then use the Navigation arrow buttons to move the lens.
- **ZOOM IN / OUT:** adjust zoom.

12. **USER PRESET A, B, C, D**

Load user presets.

13. **ALT**

Press and hold this button to access alternative functions for all buttons with a green label.

14. **DVI / DisplayPort2 / numeric input 3**

There is no DVI input on this projector.
Use with **ALT** to select the DisplayPort 2 input.

15. **HDMI 2 / HDMI 4 / numeric input 2**

Select the HDMI 2 input.
Use with **ALT** to select the HDMI 4 input. There is no HDMI 4 input on this projector

16. **HDMI 1 / HDMI 3 / numeric input 1**

Select the HDMI 1 input.
Use with **ALT** to select the HDMI 3 input. There is no HDMI input on this projector

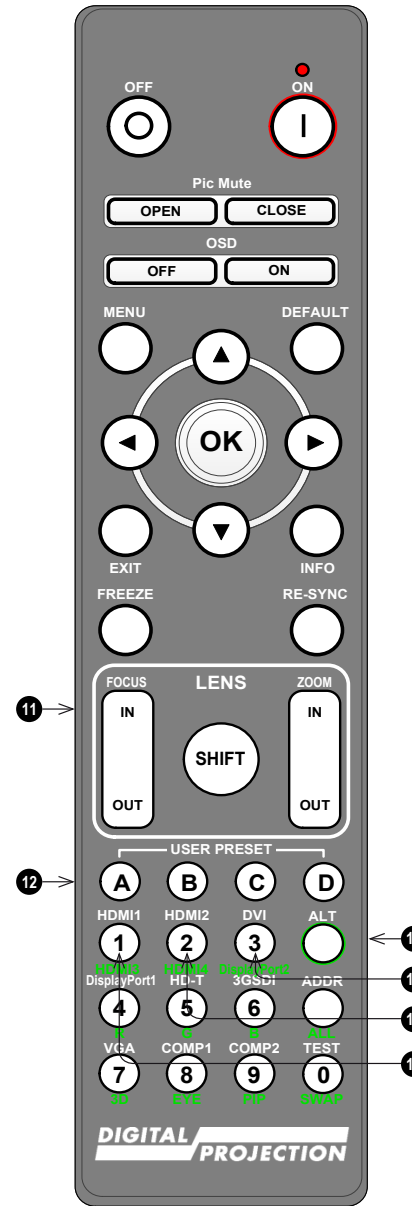

Remote Control

Notes

If focus cannot be achieved using the focus in / out feature, press Shift & 7 to adjust for far focus, or Shift & 8 to adjust for near focus.



This projector does not use the following options on the remote: DVI, VGA, COMP 1 and COMP 2.

3D is only available on the HDMI 3 and 4 inputs.

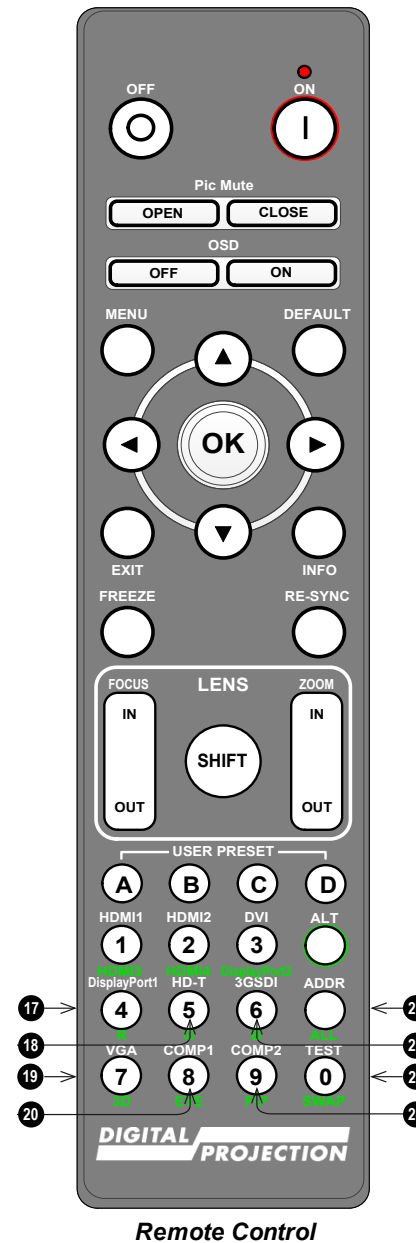
17. **DISPLAYPORT 1 / R / numeric input 4**
Select DisplayPort 1 input.
18. **HD-T / G / numeric input 5**
Select the HDBaseT input.
19. **VGA / 3D / numeric input 7**
There is no VGA input on this projector.
Use with **ALT** to toggle the 3D Format setting between Off and Auto.
20. **COMP1 / EYE / numeric input 8**
There is no Component 1 input on this projector.
Use with **ALT** to switch between left and right eye 3D dominance.
21. **ADDR / ALL (with red indicator at the top)**
Assign and unassign an IR remote address.
- **To assign an IR remote address:**
 1. Press and hold this button until the red indicator starts flashing.
 2. Release this button and while the red indicator is still flashing, enter a two-digit address using the numeric input buttons. The indicator will flash three times quickly to confirm the change.
 - **To unassign an address and return to the default address 00:**
 1. Press and hold ALT and this button simultaneously until the red indicator flashes to confirm the change.
22. **3GSDI / B / numeric input 6**
Select the 3G-SDI input.
23. **TEST / SWAP / numeric input 0**
Show a test pattern. Press again to show the next test pattern: *White, Black, Red, Green, Blue, Checkerboard, Crosshatch, V Burst, H Burst, Color Bar, Off.*
When **PIP** mode is on, use this button with **ALT** to swap the main and sub images.
24. **COMP2 / PIP / numeric input 9**
There is no Component 2 input on this projector.
Use with **ALT** to switch on **Picture In Picture (PIP)** mode.



Notes

-  *This projector does not use the following options on the remote: DVI, VGA, COMP 1 and COMP 2.*
-  *3D is only available on the HDMI 3 and 4 inputs.*
-  *PIP is not available when the projector uses input HDMI 3 or 4.*

Infrared reception

The projector has infrared sensors at the front and back.

The angle of acceptance is 40° . Make sure that the remote control is within the angle of acceptance when trying to control the projector.

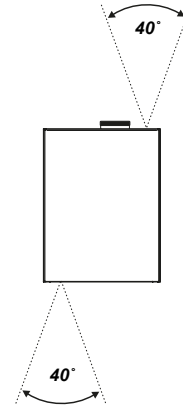

Notes

Positioning the screen and projector

1. Install the screen, ensuring that it is in the best position for viewing by your audience.
2. Mount the projector, ensuring that it is at a suitable distance from the screen for the image to fill the screen. Set the adjustable feet so that the projector is level, and perpendicular to the screen.

The drawing shows the positions of the feet for table mounting, and the fixing holes for ceiling mounting.

1. Four adjustable feet
2. **Four M10 holes for ceiling mount** The screws should not penetrate more than 15 mm into the body of the projector.

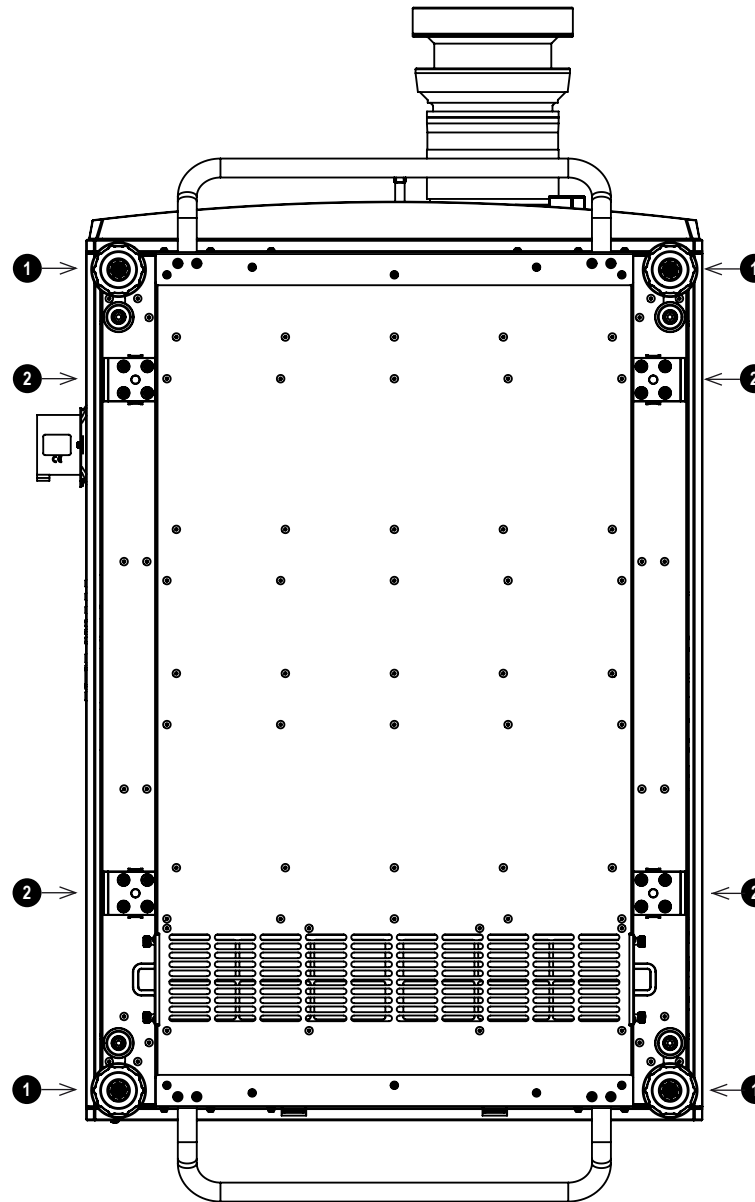

Notes



Always allow the projector to cool for 5 minutes before disconnecting the power or moving the projector.



Ensure that there is at least 50 cm (19.7 in) of space between the ventilation outlets and any wall, and 30 cm (11.8 in) on all other sides.



Do not use the threaded holes for the adjustable feet to hang or mount the projector.

Roll and pitch

The projector can be operated in numerous positions.

In portrait mode, it is recommended to position the projector with inputs facing upward, as shown in the diagram.

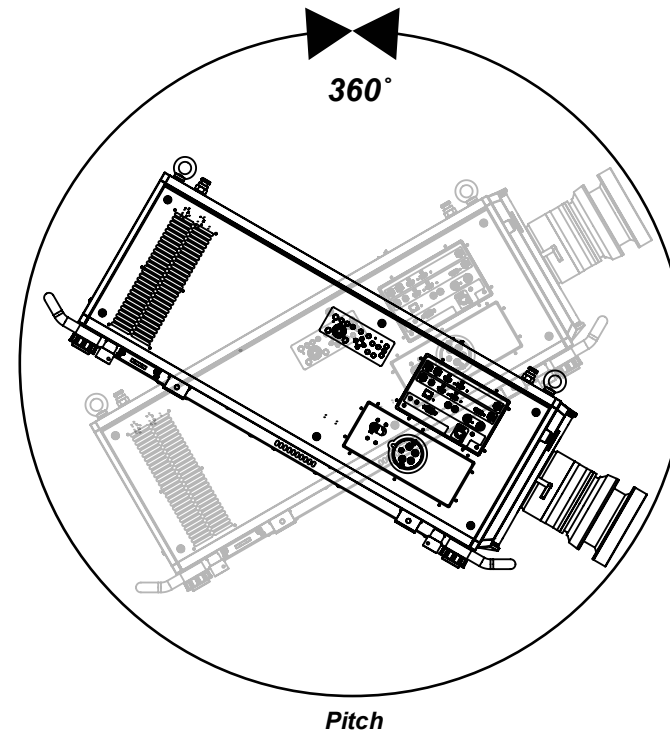
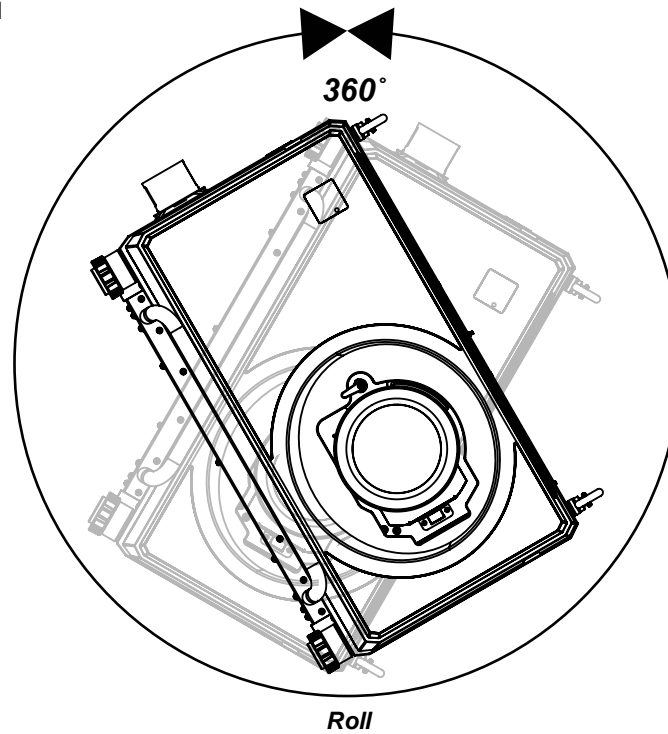

Notes

Stacking and rigging

The projector can be stacked using the pin and cups that are located on top and underneath the projector. The pin and cups can also be used to attach a mounting rail. The eye bolts on top of the projector can be used with suspension cables to fly the projector.

Pin and cup stacking

The top of the projector has pins and the bottom of the projector has cups. The pins and cups can connect together and be locked into place with a locking pin.

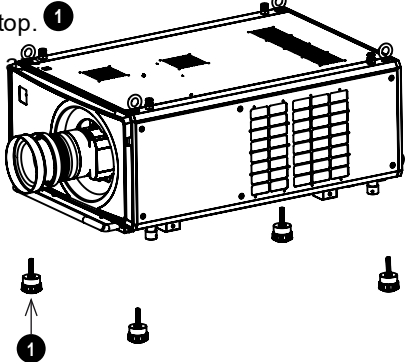
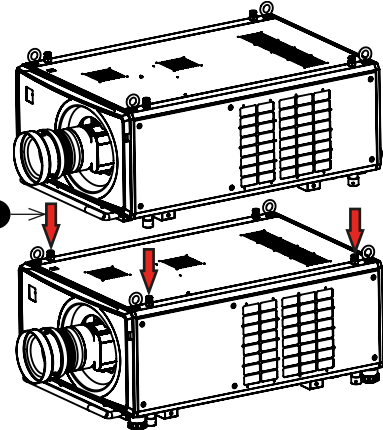
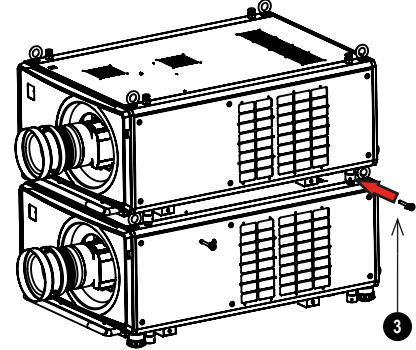
1. Remove the adjustable feet from the projector that will be stacked on the top. 
2. Mount the projector on top of the other projector. Ensure that all four cups placed over the pins on the bottom projector. 
3. Push the locking pins into place on each cup and pin. 

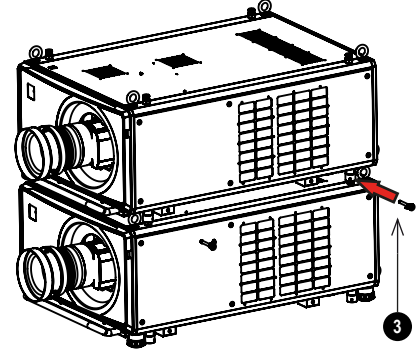
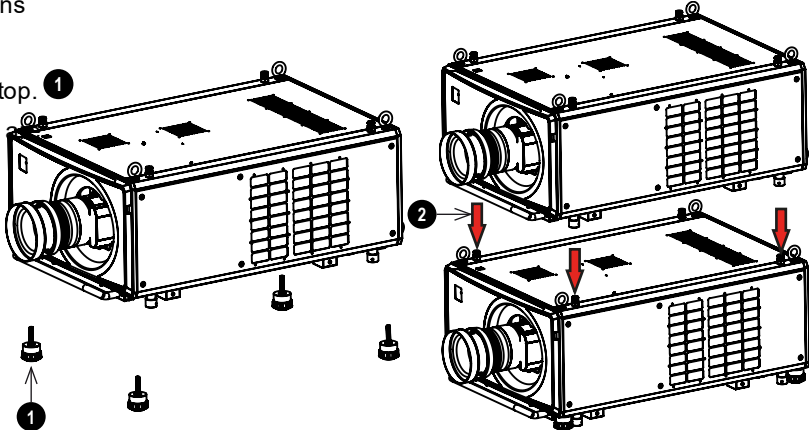

Notes



Do not use the threaded holes for the adjustable feet to hang or mount the projector.



Do not use the carry handles to hang or mount the projector.



This system should only be used to stack a maximum two projectors.

Using the eye bolts

Four eye-bolts are fitted to the top of the projector to enable the flying of the projector using steel wire or chains.

Point-to-point connections

Refer to the following guidelines when connecting one end of a suspension cable directly to an eye-bolt and the other to a suspension point.

- The suspension cables can be connected to the eye-bolts at an angle of up to 45° around the eye ring.
- The suspension cables must not be connected to the eye-bolts at any angle across the eye ring.
- The suspension cable must run vertically up from the projector.

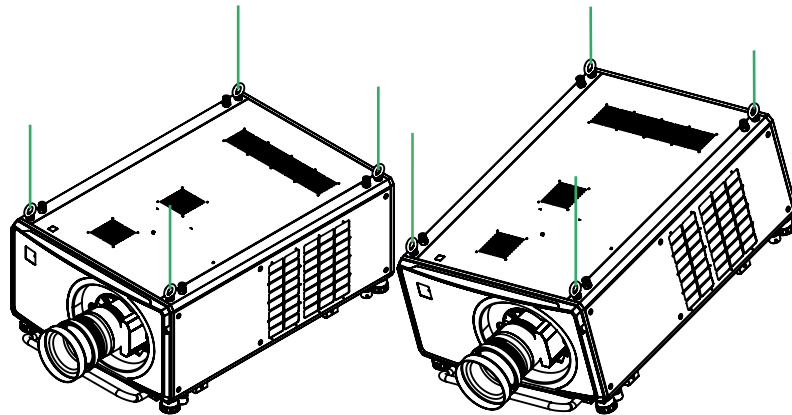
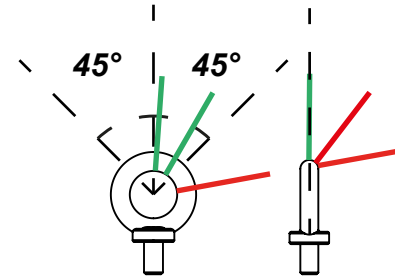

Examples of correct configurations

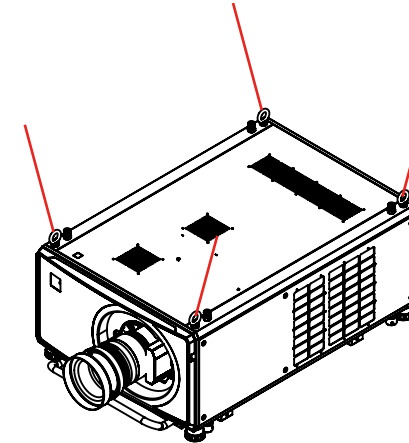

Example of an incorrect configuration

Notes



This system should only be used to fly a single projector. Do not stack projectors and fly them together.

Threaded suspension cables

Refer to the following guidelines when threading the suspension cable through the eye-bolts and connecting both ends to suspension points.

- The suspension cable can exit the eye-bolts at an angle of up to 45° around the eye ring.
- The suspension cable can exit the eye-bolts at an angle of up to 45° across the eye ring.
- The suspension cable should not be threaded through 2 or more eye-bolts

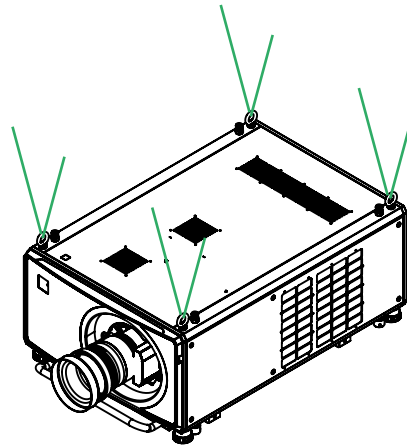

Example of a correct configuration

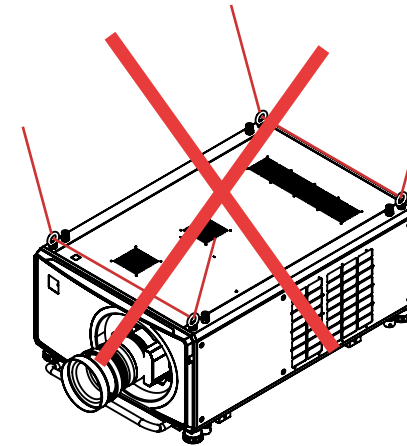
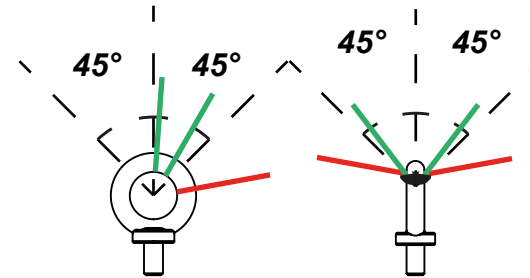

Example of an incorrect configuration

Notes

Changing the lens

Inserting a new lens

1. Turn the lens release lever clockwise so that it is pointing upwards, to open the lock fully. **1**
2. Remove the rear lens cap from the lens.

3. Insert the lens into the lens aperture, making sure that the plug on the zoom drive mechanism lines up with the socket on the front of the projector, then push the lens in firmly as far as it will go.
4. Turn the lens release lever anti-clockwise to the mid-position. **2**

5. The lens can now be pushed in further. Push the lens in firmly as far as it will go.
6. Turn the lens release lever fully anti-clockwise so that it is pointing downwards, to close the lock fully. **3**

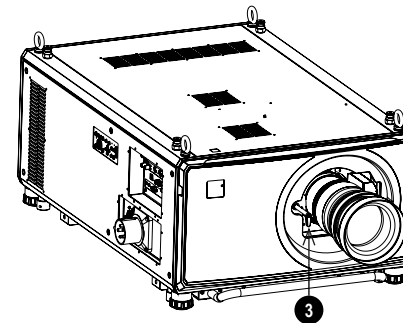
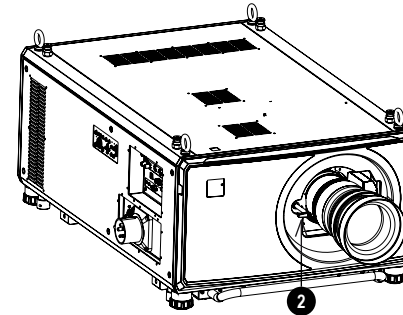
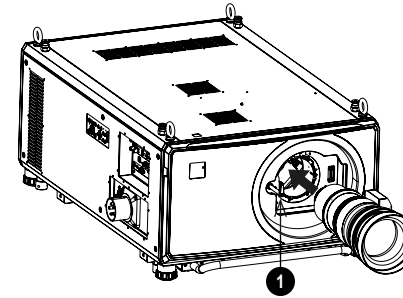

Notes



Before changing the lens, always make sure the projector is switched off and fully disconnected from its power supply.



When changing the lens, avoid using excessive force as this may damage the equipment.



Avoid touching the surface of the lens as this may result in image impairment.



The lens is shipped separately.



Take care to preserve the original lens packaging and protective caps for future use.



An adapter is available for certain third party lenses. Please see your local dealer for further information



HOTKEY 3 is used when a lens adapter is installed. Whilst in standby mode, press and hold HOTKEY 3 for five seconds to run center lens before installing the lens.

Removing the lens

To remove the lens, reverse the procedure described in Inserting a new lens above:

1. Turn the release lever up to the mid-position, then pull the lens out as far as it will go.
2. Turn the release lever clockwise so it is pointing upwards, then pull the lens out completely.

Fitting a lens hood

1. Remove the six screws. ❶
2. Remove the lens glass.
3. Place hood over the lens, aligned with the screw holes.
4. Screw in the six screws to secure the hood. ❷

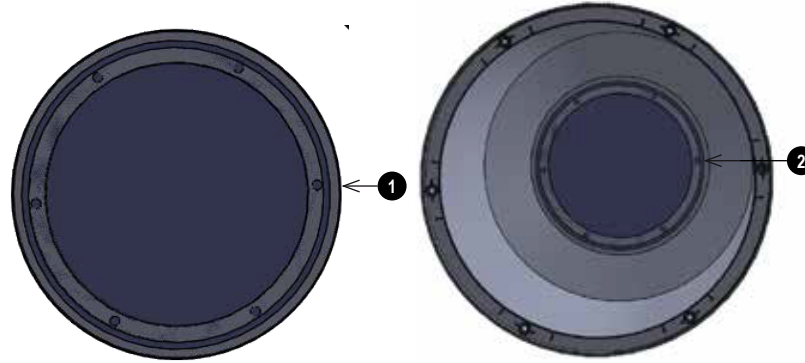

5. Place the six sponges over the locating pins on the hood. ❸
6. Place the glass and bracket over the hood.

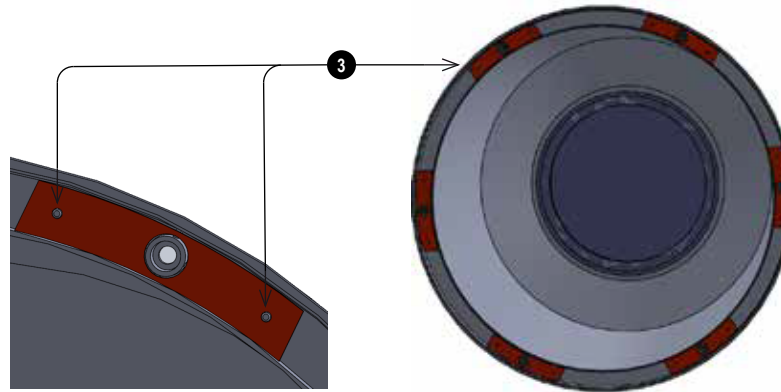

7. Screw in the six screws to secure the glass and bracket to the hood. ❹

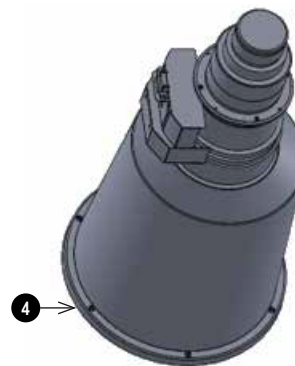

Notes

FDA regulations requires that a lens hood is permanently fitted when using the 4.16 - 6.96:1 Long Zoom1 lens with the Titan Laser range of projectors in the United States of America. Fitting can be provided by your reseller or System Integrator.

Fitting a lens stabilizing bracket

1. Remove the cover from the front of the projector
2. Remove the lens mount and lens

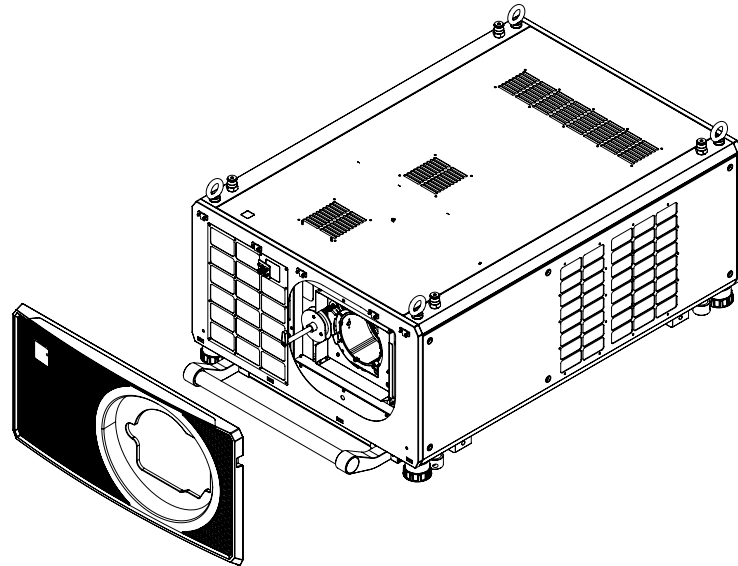

3. Remove the three M3 set screws from the lens collar
4. Remove the two M3 screws from the fixed lens bracket
5. Remove the lens collar from the lens mount

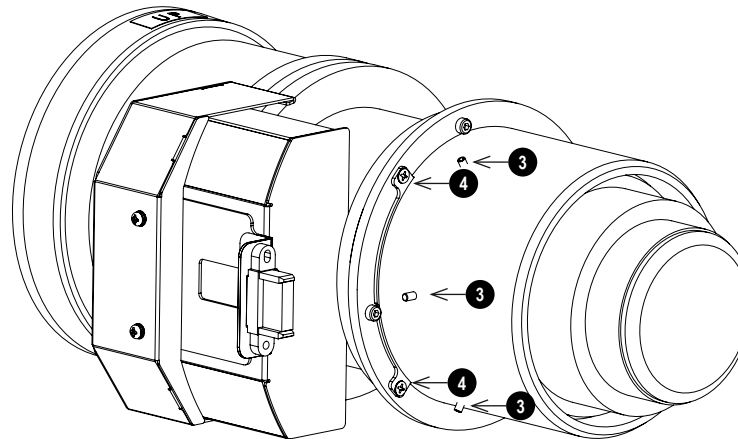

Notes

 In some applications and projector orientations, it may be necessary to fit the stabilizing bracket to the lens mount.

 The lens stabilizing bracket can only be fitted to models built from April 2019.

6. Remove the two M2 screws from the fixed lens bracket
7. Remove the fixed lens bracket

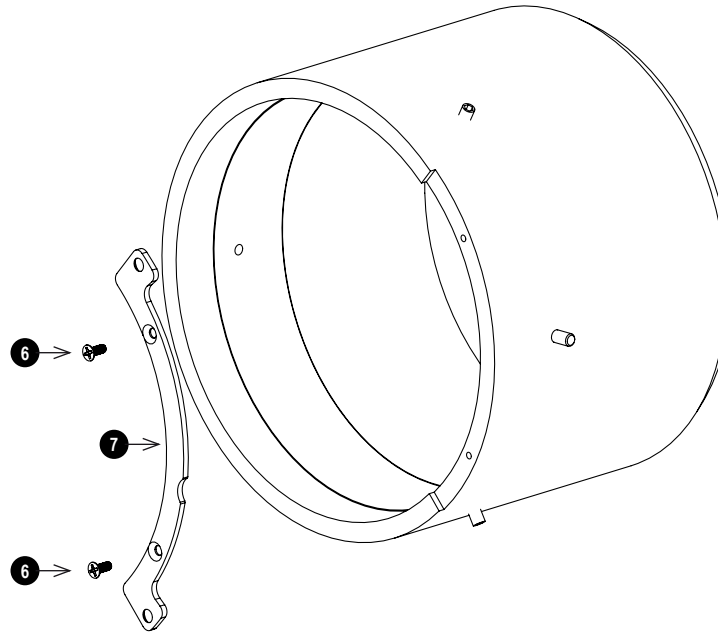

Notes

8. Place the stabilizing bracket on to the lens collar
9. Screw in the two M2 screws to fix the stabilizing bracket to the lens collar

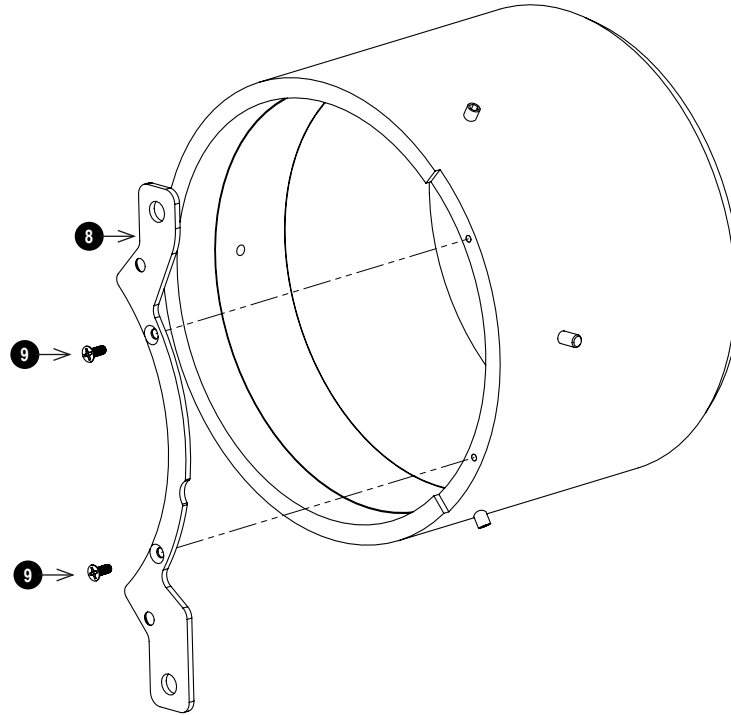

10. Place the lens collar on to the lens
11. Screw in the two M3 screws to fix the lens collar to the lens
12. Screw in the three M3 set screws to the lens collar

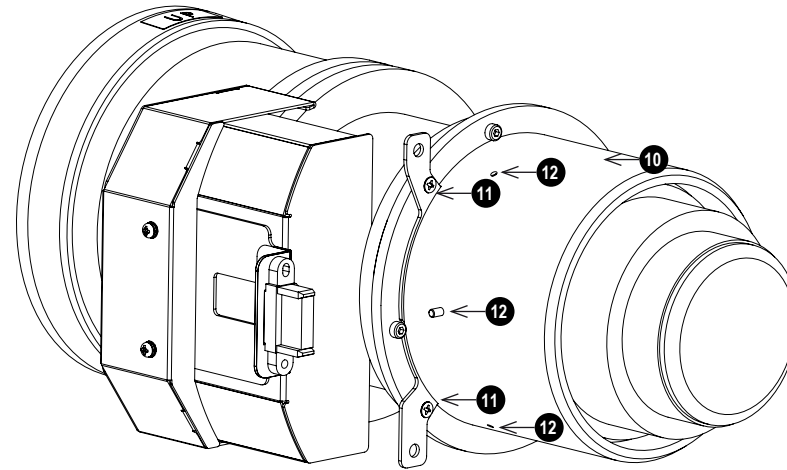

Notes

13. Place the lens into the projector
14. Screw the two fixing screws into the lens stabilizing bracket
15. Place the cover over the front of the projector

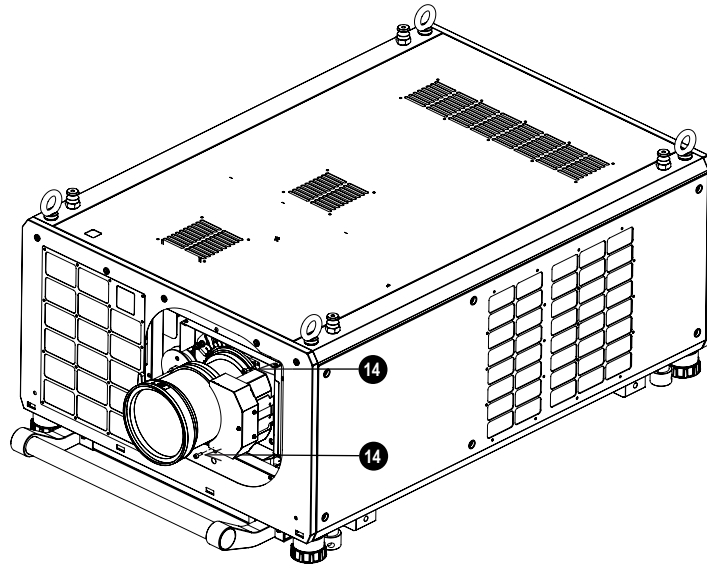
**Notes**

Operating the projector

Switching the projector on

1. Connect the power cable between the mains supply and the projector. (See Connecting the power supply above.) Switch the breaker switch next to the power connector to on.
The POWER indicator turns red to signal that the projector is on and in STANDBY mode.
2. Press one of the following buttons:
 - On the remote control, the ON button
 - On the projector control panel, the POWER button.

The POWER indicator begins flashing green as the projector powers up. When the flashing stops, the POWER indicator lights solid green and the Digital Projection logo appears on the screen. The projector is switched on and projecting.

Switching the projector off

1. Press OFF on the remote control or POWER on the control panel, then press again to confirm your choice.
The POWER indicator on the control panel will start flashing blue, the projected image will turn off and the cooling fans will run for a short time until the POWER indicator goes steady red to indicate that the projector has entered STANDBY mode.
2. If you need to switch the projector off completely, switch the breaker switch next to the power connector to off and then disconnect the power cable from the projector.

Selecting an input signal

1. Connect one or more image sources to the projector.
2. Select the input you want to display:
 - Press one of the input buttons on the remote control.
 - Alternatively, open the On-screen display (OSD) by pressing **MENU**. Highlight **Input** from the main menu, press **ENTER/OK** and then select an input signal using the **UP** and **DOWN** arrow buttons. Press **ENTER/OK** to confirm your choice.

Selecting a test pattern

To display a test pattern:

- Press **TEST** on the remote control.
Change the test pattern using the **LEFT** and **RIGHT** arrow buttons. The following test patterns are available: *White, Black, Red, Green, Blue, Checkerboard, Crosshatch, V Burst, H Burst, Color Bar, Off*.
- Alternatively, open the OSD by pressing **MENU**. Highlight **Test Patterns** from the main menu, then select a test pattern using the **LEFT** and **RIGHT** arrow buttons.

After the final test pattern, the projector exits test pattern mode and returns to the main image. To view test patterns again, you need to press **TEST** again. If you wish to exit the test patterns before you reach the final one, press **TEST** or **EXIT** at any time.

Notes



See *Connecting the power supply* on page 13.



The self-test is running when all the LEDs on the control panel are lit.



Use only the power cable provided.



Ensure that the power outlet includes a ground connection as this equipment MUST be earthed.



Handle the power cable carefully and avoid sharp bends. Do not use a damaged power cable.



See *Using the menus* on page 44 for full details of how to use the controls and the menu system.

Adjusting the lens

The lens can be adjusted using the Lens menu, or using the lens buttons on the remote control.

Lens menu

The **Lens** menu provides access to the **Lens Control** setting and the **Lens Center** command.

Lens Control allows **Zoom**, **Focus** and **Shift** adjustments using the arrow buttons. The setting operates in **Zoom/Focus Adjustment** and **Shift Adjustment** mode.

Press **ENTER/SELECT** to switch between the two modes.

Remote control

Use the remote control to adjust zoom, focus and shift directly, without opening a menu:

- **OK** enters lens control, then switches between Zoom/Focus Adjustment and Shift Adjustment.
- **EXIT** exits lens control and opens the Lens menu.
- **MENU** exits lens control and returns to the main image.
- The arrow buttons adjust zoom, focus and shift as indicated on the screen.

Adjusting the image

Orientation

This can be set from the **Setup** menu.

Highlight **Orientation** and choose from **Front Tabletop**, **Front Ceiling**, **Rear Tabletop**, **Rear Ceiling** and **Auto-front**.

Geometry

Settings such as **Keystone**, **Rotation**, **Pincushion / Barrel** and **Arc** can be set from the **Geometry** menu.

Picture

Settings such as **Gamma**, **Brightness**, **Contrast**, **Saturation**, **Hue** and **Sharpness** can be set from the **Image** menu.

Notes



See Remote control on page 17 for full details of how to adjust the lens using the remote control.



Neither of the settings under Picture are available with the HDMI 3 and 4 inputs.

This page is intentionally left blank

DIGITAL **PROJECTION**

A Delta Associate Company

Titan LaserWUXGA

High Brightness Digital Video Projector

CONNECTION GUIDE



Signal inputs

Digital inputs and outputs

1. **HDMI 1 / HDMI 2**
HDMI 2.0 inputs supporting HDCP 2.2. Connect an **HDMI** cable to the connector.
2. **HDMI 3 / HDMI 4**
HDMI 1.4b inputs supporting **Frame Sequential** and **Dual Pipe 3D** with HDCP 1.4. Also supports the domestic Blu-Ray formats. See supported signal input modes on page 121. Connect an **HDMI** cable to the connector.
3. **DisplayPort**
DisplayPort 1.2 input. Connect a DisplayPort cable to the connector. Supports sources up to 4K-UHD resolution at 60 Hz and WQXGA at 120Hz.
4. **HDBaseT/LAN**
Receives digital signal from HDBaseT-compliant devices. Connect an HDBaseT cable.
5. **Ethernet/ArtNet**
Provides LAN connectivity via an ethernet or ArtNet cable.
6. **3G-SDI in**
Connect a 3G-SDI cable to distribute the 3G-SDI signal to another projector.
7. **3G-SDI out**
Connect a 3G-SDI cable to distribute the 3G-SDI signal to another projector.

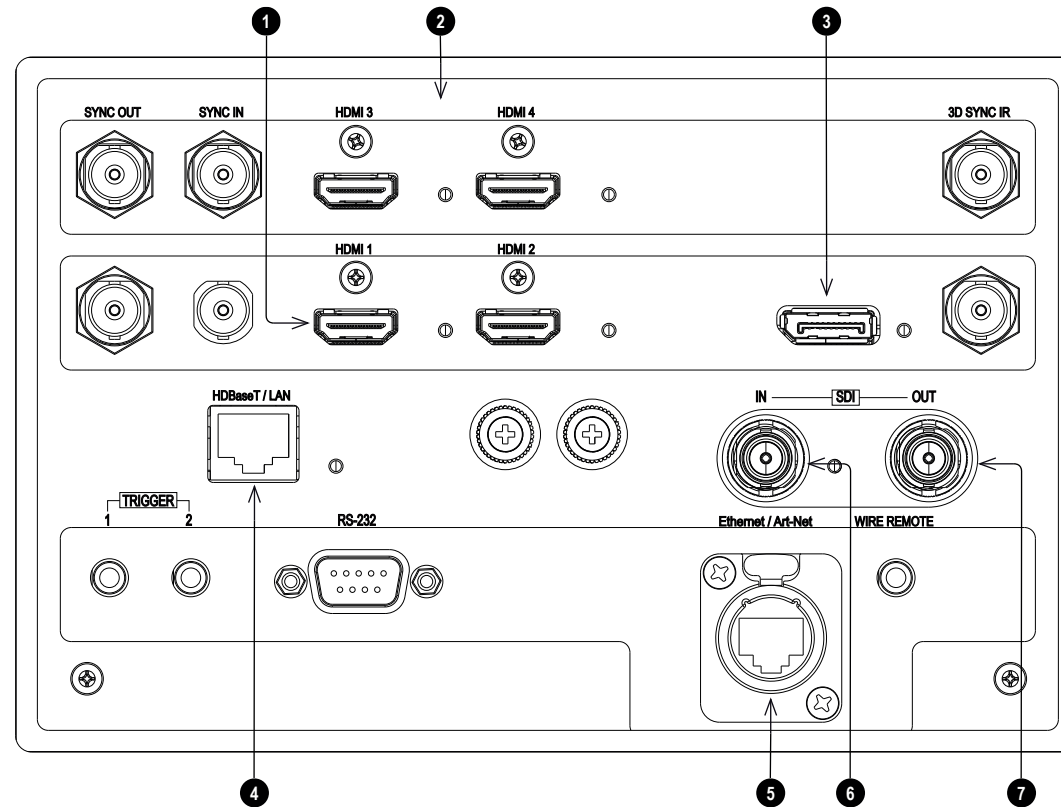

Notes

For simultaneous HDBaseT and LAN connectivity, a third-party distribution product can be utilised to combine HDBaseT video stream with LAN connection for delivery to the projector.

EDID on the DisplayPort, HDMI, and HDBaseT inputs

If you are using a computer graphics card or another source that obeys the EDID protocol, the source will automatically configure itself to suit the capability of the projector.

Otherwise refer to the documentation supplied with the source to manually set the resolution to the DMD™ resolution of the projector or the nearest suitable setting. Switch off the source, connect to the projector, then switch the source back on again.

Using DisplayPort/ HDMI/ HDBaseT switchers with the projector

When using a DisplayPort/HDMI/HDBaseT source switcher with the projector, it is important to set the switcher so that it passes the projector EDID through to the source devices.

If this is not done, the projector may not be able to lock to the source or display the source correctly as its video output timings may not be compatible with those of the projector. Sometimes this is called transparent, pass-through or clone mode. See your switcher's manual for information on how to set this mode.

1. Sources
2. Switcher
3. Projector

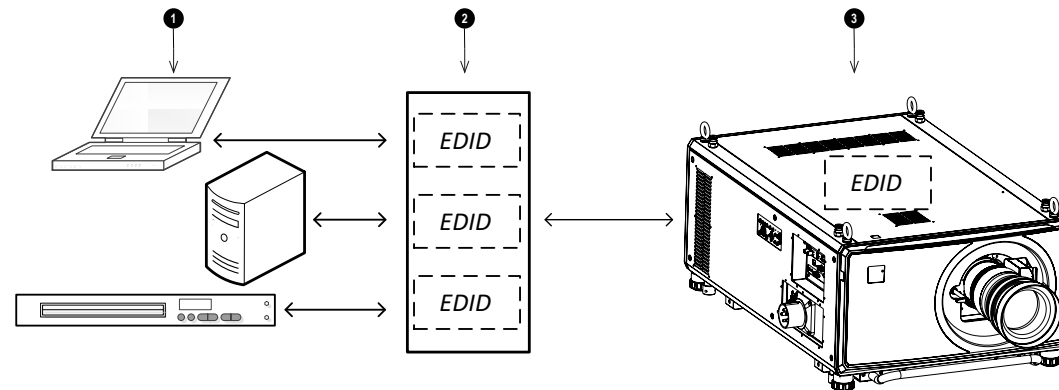

The EDIDs in the switcher should be the same as the one in the projector.

Notes

3D connections

1. Sync In / Sync Out

Sync In is the 3D sync input signal. Connect the 3D sync from your graphics card or server.

Sync Out is the 3D sync output signal. Enables 3D from multiple projectors.

2. HDMI 3 / HDMI 4

HDMI 1.4b inputs supporting **Frame Sequential** and **Dual Pipe** 3D with HDCP 1.4. Also supports the domestic Blu-Ray formats. See supported signal input modes on page 121. Connect an **HDMI** cable to the connector.

3. 3D Sync IR

Sync output signal. This is affected by settings in the 3D menu such as Dark Time and 3D Sync Offset. Connect this to an IR emitter or ZScreen.

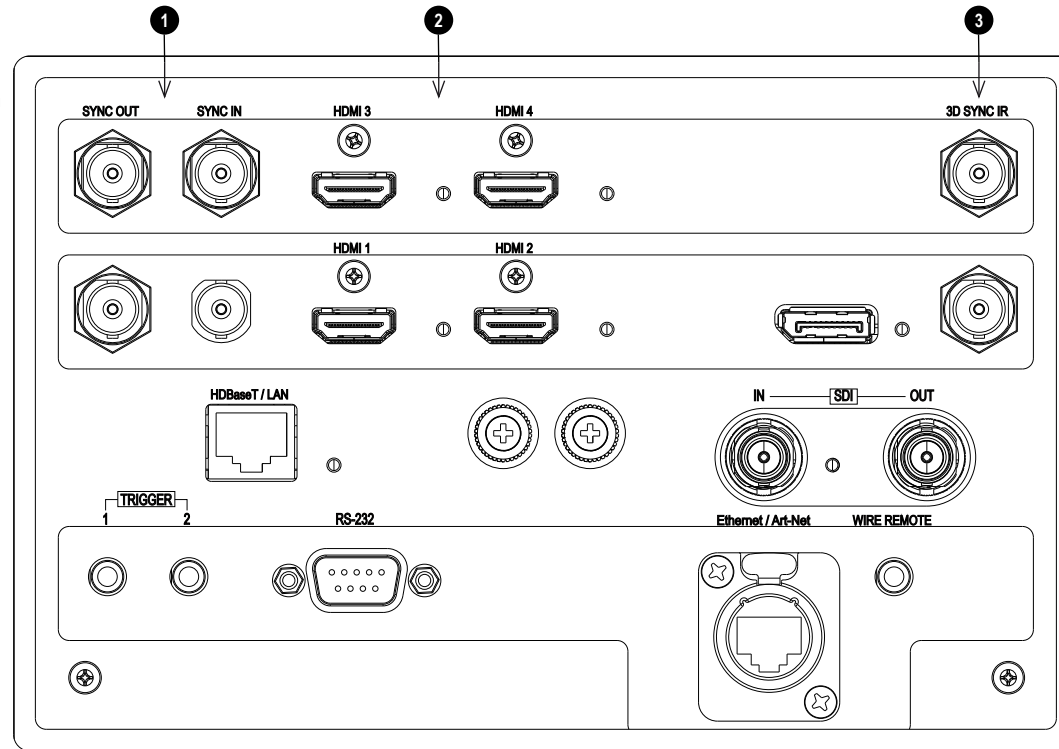

Notes

Frame sequential 1080p 3D up to 120Hz and WUXGA 3D at 100Hz

1. Connect to HDMI 3 or 4.
2. Set **3D Format** in the **3D** menu to **Frame Sequential**.

Dual Pipe 1080p and WUXGA 3D sources at up to 100 and 120Hz

1. Connect the left eye output to the **HDMI 3** socket and the right eye output to the **HDMI 4** socket.
2. Set **3D Format** in the **3D** menu to **Dual-Pipe**.

See 3D formats on page 124 for a complete list of supported formats and frame rates.

3D Sync

- 1. 3D Input
- 2. 3D Sync In
- 3. 3D Sync IR
- 4. IR emitter or Zscreen

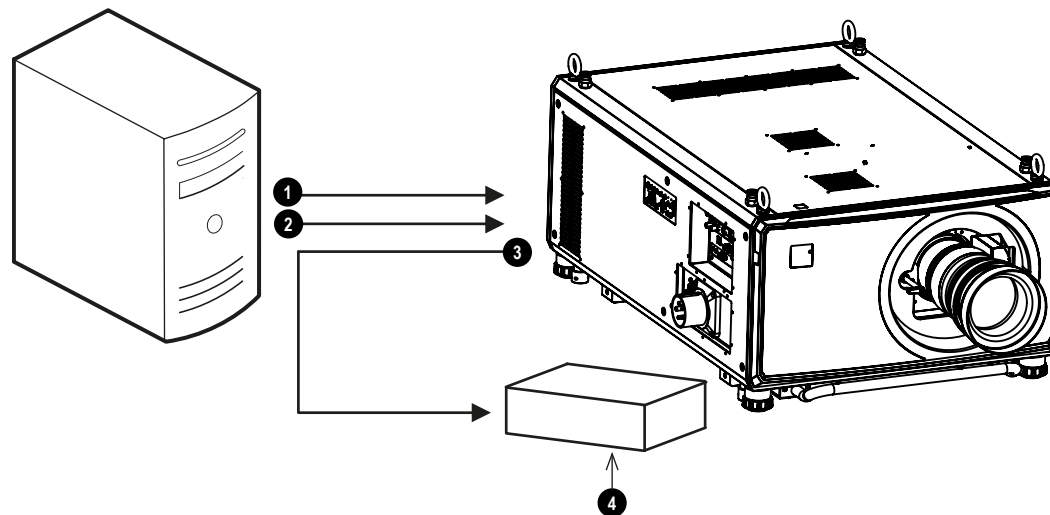

Notes

Control connections

1. Trigger 1 & Trigger 2

The Trigger outputs are defined in the **Setup** menu. Each output can be triggered by one of the following conditions:

- **Screen trigger.** A trigger output can be used to control an electrically operated screen. The screen will be automatically deployed when the projector starts up and retracted when the projector shuts down.
- **Aspect ratio trigger.** A trigger output can be used to control screen shuttering for different aspect ratios.
- **RS232 trigger.** A trigger output can be used to control the screen or screen shuttering on receipt of an RS232 command.

2. HDBaseT/LAN

The projector's features can be controlled via a LAN connection, using Digital Projection's **Projector Controller** application or a terminal-emulation program.

3. RS232

All of the projector's features can be controlled via a serial connection, using commands described in the **Protocol Guide**. Use a straight-through cable to connect directly to a computer.

4. Ethernet/ArtNet

This dedicated LAN connection can be used if **HDBaseT/LAN** is already being used for HDBaseT signal input.

5. Wired Remote

The remote control can be connected using a standard 3.5 mm mini jack cable (tip-ring-sleeve, or TRS).

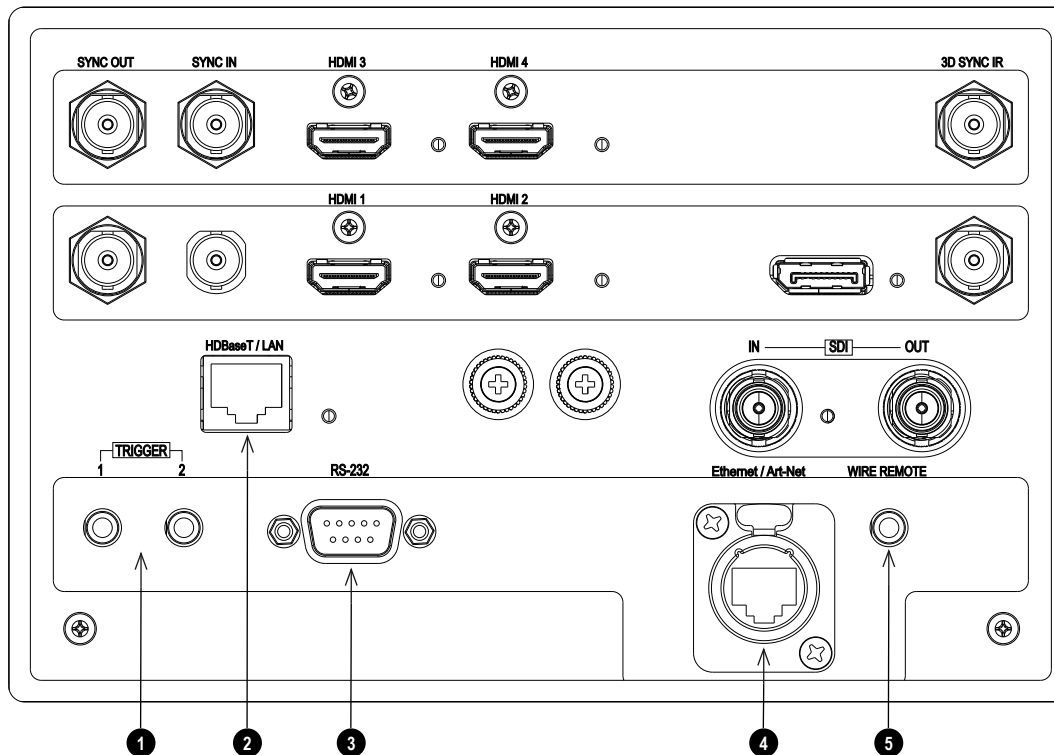

Notes

For a list of all commands used to control the projector via LAN, see the **Protocol Guide** (available separately).

Only one remote connection (RS232 or LAN) should be used at any one time.

With a LAN connection the projector can serve a web page offering status and projector controls.

Trigger 1 and Trigger 2 are not available with HDMI 3 and 4 inputs.

Projector Controller is available for download, free of charge, from the Digital Projection website.

LAN connection examples

The projector's features can be controlled via a LAN connection, using Digital Projection's **Projector Controller** application or a terminal emulation program.

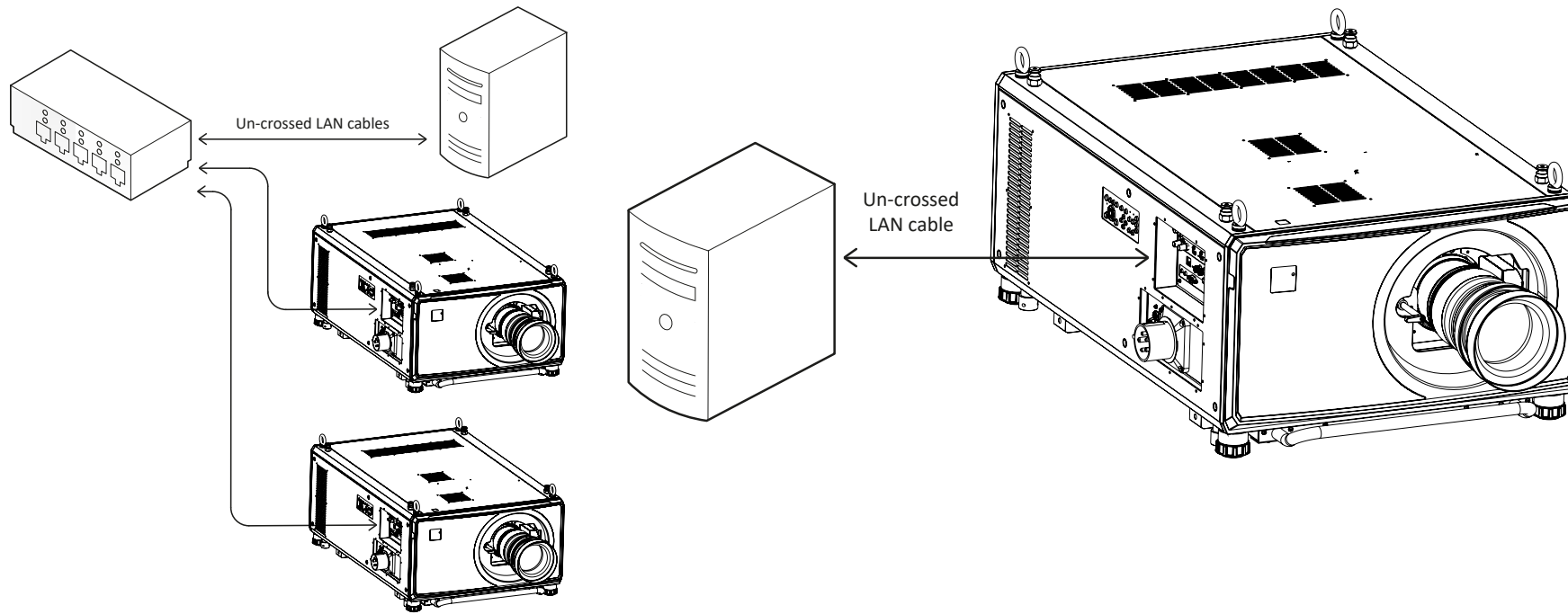

Notes

With a LAN connection the projector can serve a web page offering basic projector controls.

Projector Controller is available for download, free of charge, from the Digital Projection website.

For simultaneous HDBaseT and LAN connectivity, a third-party distribution product can be utilised to combine HDBaseT video stream with LAN connection for delivery to the projector.

RS232 connection example

All of the projector's features can be controlled via a serial connection, using commands described in the **Protocol Guide**.

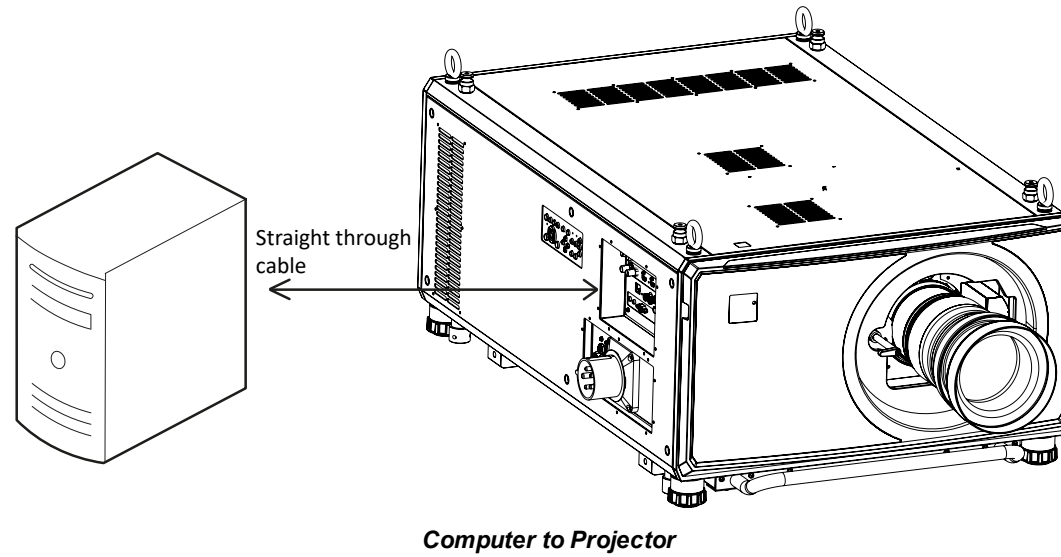

Notes



The **Protocol Guide** is available separately

DIGITAL **PROJECTION**

A Delta Associate Company

***Titan Laser* WUXGA**

High Brightness Digital Video Projector

OPERATING GUIDE



Using the menus

Opening the Menu

Access the various menus using either the projector control panel or the remote control. On either device:

1. Press the **MENU** button.
The on-screen display (OSD) opens showing the list of available menus

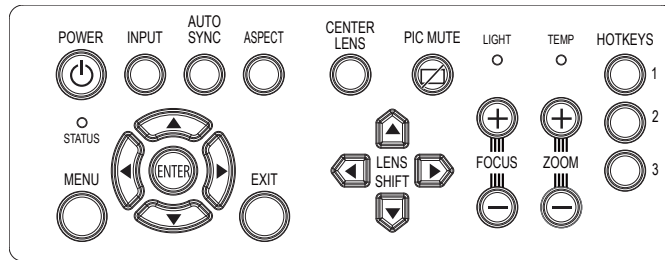

Projector control panel

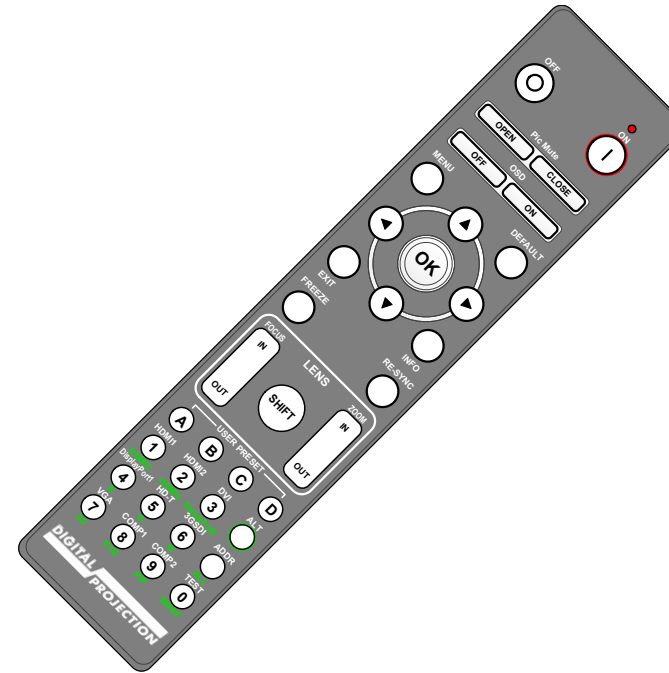

Remote control

Opening a submenu

Move up and down the list using the **UP** and **DOWN** arrow buttons.

To open a submenu:

1. Press **ENTER** on the control panel or **OK** on the remote control.

This guide refers to the above two buttons as **ENTER/OK**.

Notes

Exiting menus and closing the OSD

To go back to the previous page:

1. Press **EXIT**.

To close the OSD:

1. Press **MENU**.

Or:

1. Go back to the top level menu
2. Press **EXIT**.

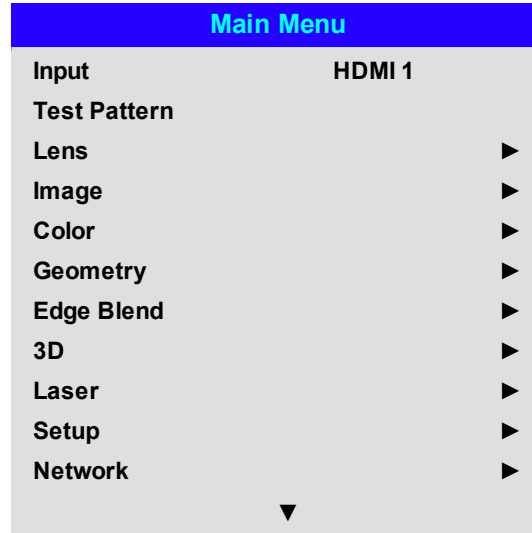

On Screen Display (OSD): Top Level Menu

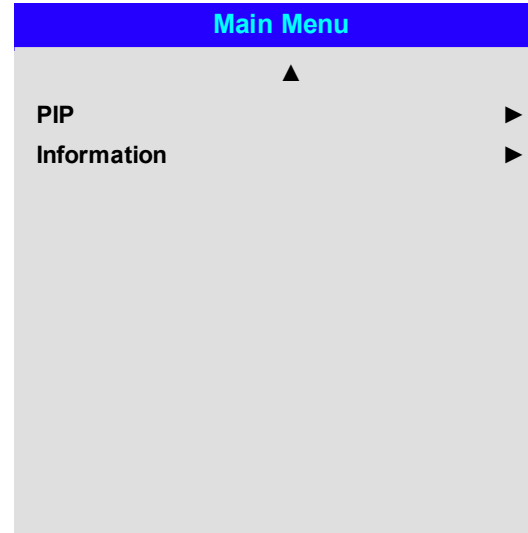

OSD: Top Level Menu Continued

Inside a menu

When you open a menu, the page consists of the following elements:

- Title bar at the top shows which menu you have accessed.
- Highlighted item
- Available and unavailable items Unavailable items appear a pale gray color. Whether an item is available may depend on other settings.
- The text or symbol to the right of an item shows whether the item:
 - has a value that can be changed (the current value is shown)
 - opens a sub-menu (an arrow button is displayed)
 - executes a command (the space to the right of the item is blank).

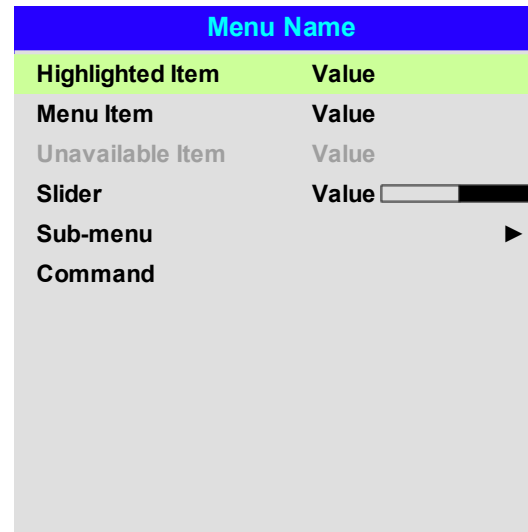

Inside a menu

 *The highlighted item has green background.*

Notes

Accessing sub menus

Use the **UP** and **DOWN** arrow buttons to highlight the sub-menu, then press **ENTER/OK**.

Executing commands

If the item contains a command, highlighting it reveals an **OK** button.

Press **ENTER/OK** to execute the highlighted command.

You may be asked for confirmation. Use the **ENTER/OK** to confirm, or **EXIT** to cancel.

Menu Name	
Menu Item	Value
Highlighted Command	OK

Highlighted Command

Command Name
Warning All [Menu] values will be lost.
Press OK to confirm Press Exit to cancel

Confirmation Dialog

Notes

Editing projector settings

If the highlighted menu item contains a list of values to choose from, you can change the value by doing the following:

1. Highlight the menu item and press **ENTER/OK**.
2. In the list of values that opens, use the **UP** and **DOWN** arrow buttons to highlight a value, then press **ENTER/OK** again to select the highlighted value.

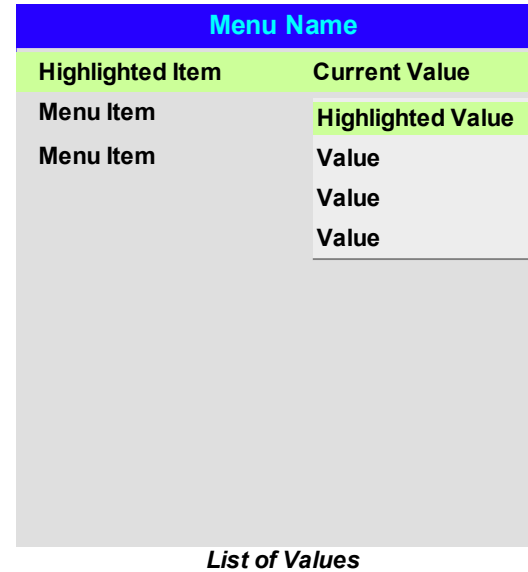

Using a slider to set a value

Some parameters open a slider. To set such a parameter:

1. Press the **LEFT** or **RIGHT** arrow button, or **ENTER/OK**. The arrow buttons will open the slider and adjust the value at the same time. **ENTER/OK** will open the slider without altering the initial value.
2. Use the **LEFT** and **RIGHT** arrow buttons to move the slider.
3. When ready, press **EXIT** to exit the slider and return to the menu, or press **MENU** to exit the slider without showing the menu again.

Notes



Some menu items may be unavailable due to settings in other menus. Unavailable menu items appear gray

Editing numeric values

Some parameters take numeric values without using sliders - for example, color matching values or IP addresses.

1. Use the **UP** and **DOWN** arrow buttons to highlight the row containing the numeric field you wish to edit.
2. Press **ENTER/OK** to enter edit mode. A numeric field in edit mode is white text on blue background.
3. In edit mode:
 - Use the **UP** arrow button to increase the numeric value.
 - Use the **DOWN** arrow button to decrease the numeric value.
4. Use the **LEFT** and **RIGHT** arrow buttons to edit the next or previous numeric fields within the same row.
5. Once ready, press **ENTER/OK** to exit edit mode.

Data	
Row	x: 0.658 y: 0.339
Highlighted Row	x: 0.315 y: 0.662
Row	x: 0.146 y: 0.043
Row	x: 0.276 y: 0.283

Notes

Using the projector

Main menu

- **Input**
Press **ENTER/OK** to open the list of available inputs. Use the **UP** and **DOWN** arrow buttons to select an input from the list, then press **ENTER/OK** to confirm your choice. Press **EXIT** to return to the main menu.
- **Test Pattern**
Choose from: *White, Black, Red, Green, Blue, Checkerboard, Crosshatch, V Burst, H Burst, Color Bar, Off*. Use the **LEFT** and **RIGHT** arrow buttons to switch between values.
- **Lens, Image, Color, Geometry, Edge Blend, 3D, Laser, Setup and Network.**
Press **ENTER/OK** to open these menus and access various settings.

Press the **DOWN** arrow at the bottom of the page to access additional menus:

- **PIP and Information**
Press **ENTER/OK** to open these menus and access various settings.

Press the **UP** arrow to return to the previous page.

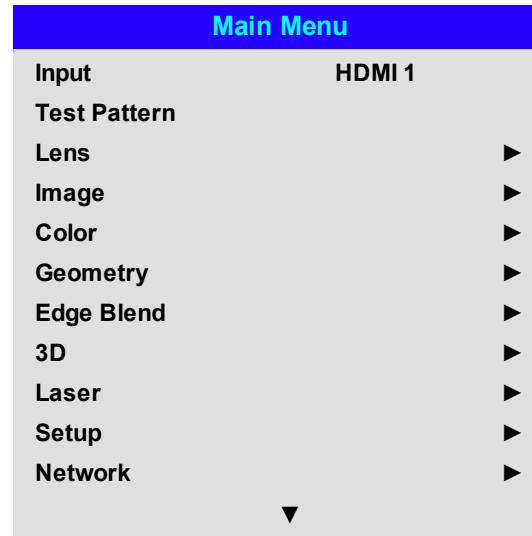

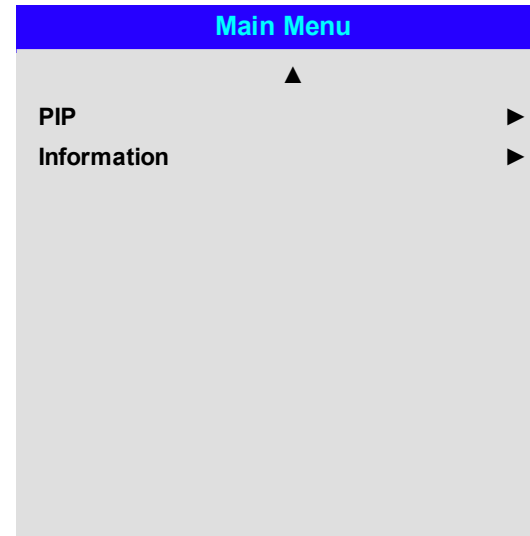

Main Menu, page 1



Main menu, page 2

Notes

 See *Signal inputs* on page 36 for information about the available inputs and connections.

 Selecting a test pattern hides the OSD. Press **EXIT** to hide the test pattern, and then press **MENU** to show the OSD

Lens menu

- **Lens Lock**
When this feature is **On**, all other Lens menu items are disabled.
- **Lens Control**
Opens a sub-menu, see below.
- **Center Lens**
Centers the lens.
- **Lens Type**
Choose from *1.4~1.9:1*, *1.8~2.6:1*, *2.5~4.2:1*, *4.1~7.0:1*, *0.7:1*, *1.1:1*, *1.2~1.5:1*, *6.9~10.4:1*.
Select the lens that is installed on the projector.
- **Lens Memory**
Opens a sub-menu, see next page.

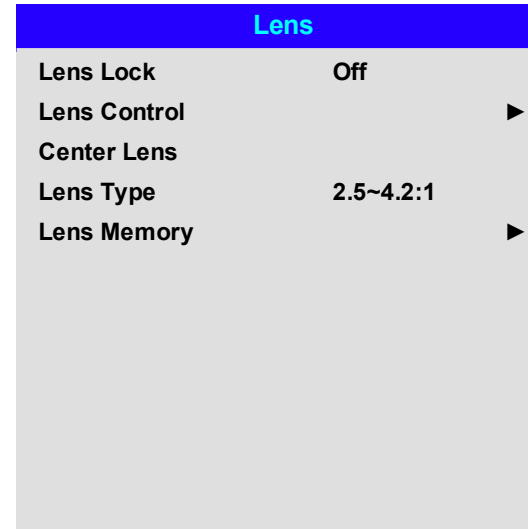

Lens control

Lens Control settings operate in **Zoom/Focus Adjustment** and **Shift Adjustment** mode. Press **ENTER/OK** to switch between modes.

When in **Zoom/Focus Adjustment** mode:

- Use the **UP** and **DOWN** arrow buttons to adjust **Zoom**.
- Use the **LEFT** and **RIGHT** arrow buttons to adjust **Focus**.

When in **Shift Adjustment** mode, use the arrow buttons to adjust **Shift**.

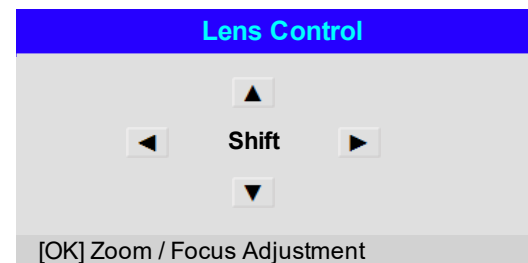
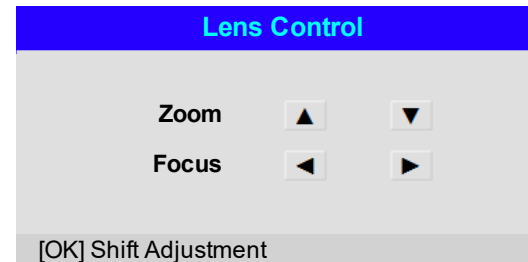

Notes

 If focus cannot be achieved using the focus feature, press **Shift & 7** on the remote control to adjust for far focus, or **Shift & 8** to adjust for near focus.

Lens memory

This menu allows you to load, save and delete up to ten lens presets, containing position, zoom, focus and shift adjustment information.

For example, if using different screen sizes and aspect ratios, you can save zoom, focus and positioning for each screen size and aspect ratio in a dedicated preset.

Use **Clear Memory** to delete a memory preset if you need to save a new combination of lens settings in its place. Overwriting a saved memory preset is not possible.

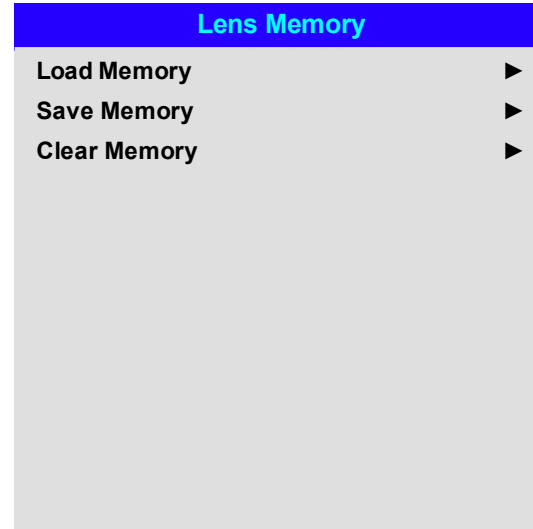

Notes

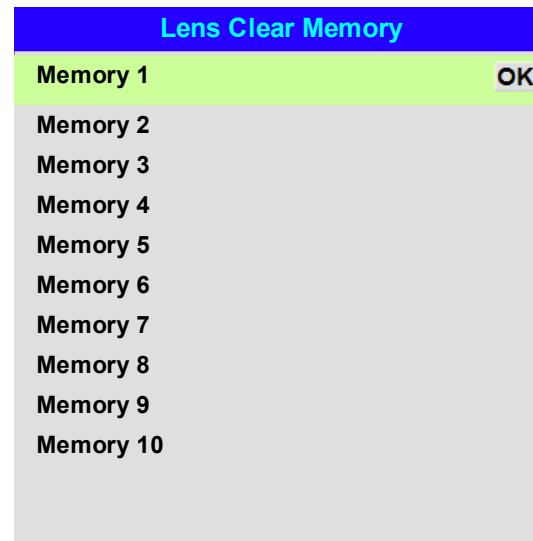
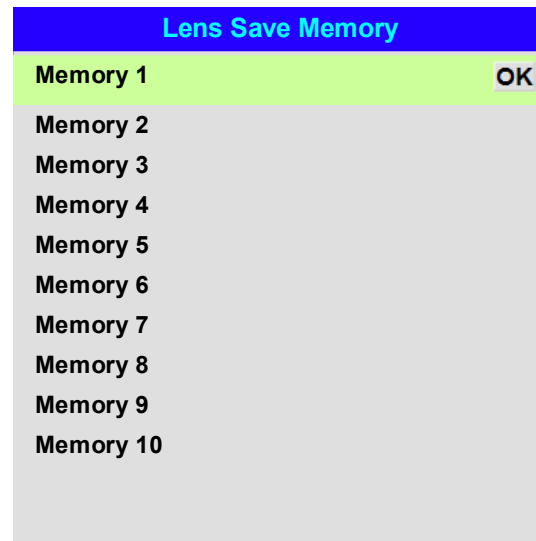
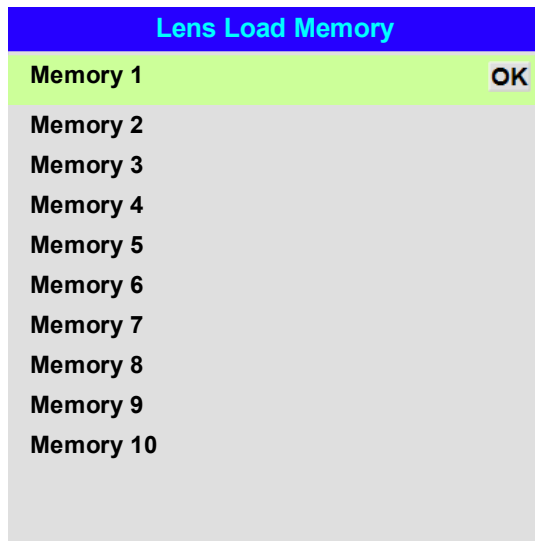
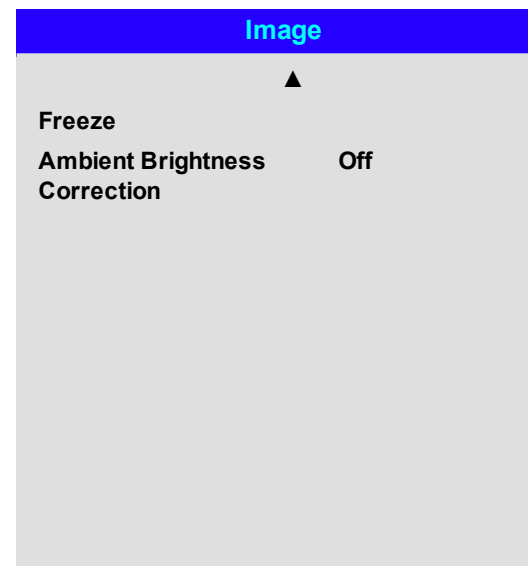
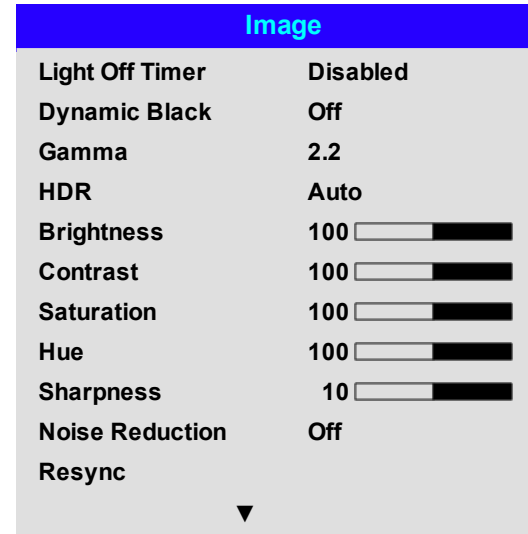

Image menu

- Dynamic Black**
 Set to On to allow for increased contrast in darker scenes by modulating the light source.
- Light Off Timer**
 When **Dynamic Black** is **On**, the **Light Off Timer** will define if laser light source will turn off after a period of time has passed. The options are: **Disable, 0.5, 1.0, 1.5, 2.0, 3.0, 4.0** seconds.
- Gamma**
 Choose a de-gamma curve from **1.0, 1.8, 2.0, 2.2, 2.35, 2.5, S-Curve, and DICOM**.
 Used correctly, the **Gamma** setting can improve contrast while maintaining good details for blacks and whites.
 If excess ambient light washes out the image and it is difficult to see details in dark areas, lower the **Gamma** setting to compensate. This improves contrast while maintaining good details for blacks.
 Conversely, if the image is washed out and unnatural, with excessive detail in black areas, increase the setting.
DICOM is a simulated DICOM display, which can be used for training applications.
- HDR**
 Choose from **AUTO, RPQ-500, RPQ500, RPQ1000** and **HDRHLG**.
 HDR (High Dynamic Range) is a new form of gamma developed to create more realistic experience when viewing images delivered using this format, such as scenes with bright sunlight. Unlike traditional gamma HDR is not device or installation independent. HDR content will come with a recommended brightness regardless of screen size. For best results as a guideline the following screens sizes are suggested.



Notes

The following settings are not available with input HDMI 3 or HDMI 4:

Image > Dynamic Black, Brightness, Contrast, Saturation, Hue, Sharpness, Noise Reduction, Freeze, Resync.

Color > Color Space.

Geometry > Aspect Ratio, Digital Zoom, Overscan.

Setup > Screen Setting, Auto Source, Trigger-1, Trigger-2.

PIP > all settings.

Selecting a HDR setting will disable the Gamma setting.

If the HDR setting is Auto, the Gamma setting is only disabled when the image source is HDR

The HDR AUTO setting is only available when the incoming signal is HDR capable

HDR Screen sizes Model	Lumens	Screen width (cm)			
		400 NIT	500 NIT	1000 NIT	4000 NIT
Titan Laser WU	29,000	607.6cm	543.5cm	384.3cm	192.2cm
Titan Laser WU	37,000	686.4cm	613.9cm	434.1cm	217.1cm

HDR options should only be used with media players and sources equipped with HDR and HDR content.

Perceptual Quantizer (PQ) is the digitizing concept for capture and display and provides metadata to enable the display to understand the coding of the content.

The NIT numbers relate to the brightness of the viewing conditions in NIT. NIT is the unit of brightness measurement for monitors and LED walls that emit light rather than reflect it such as a projection screen. However it is a reference to the brightness you would choose for a given environment.

HDRHLG is High Dynamic Range – hybrid-log-gamma. This is a broadcast version of HDR for live TV and events.

- **Brightness, Contrast, Saturation, Hue, Sharpness**

Highlight the setting you wish to edit, and then press **ENTER/OK**, or the **LEFT** or **RIGHT** arrow button to open the slider.

Use the **LEFT** and **RIGHT** arrow buttons to adjust the slider.

Press **EXIT** to close the slider and return to the menu, or **MENU** to close the slider and return to the projected image.

- **Resync**

Press **ENTER/OK** to force the projector to resynchronise with the current input

- **Noise Reduction**

Choose a level of noise reduction from **Off**, **Low**, **Middle** and **High**.

- **Freeze**

Freezes the current frame.

- **Ambient Brightness Correction**

Choose from; **Off**, **BC1**, **BC2**, **BC3**, **BC4**, **BC5**, **BC6**

This adjusts brightness, contrast, saturation, hue and sharpness settings to levels that are pre-configured for different levels of ambient light.

Notes



Brightness, Contrast, Saturation, Hue, Sharpness and Noise Reduction are not available with the HDMI 3 and HDMI 4 inputs

Color menu

Color	
Color Space	Auto
Color Mode	ColorMax
ColorMax	Peak
Manual Color Matching	▶
Color Temperature	Native
Gains and Lifts	▶

Color space

In most cases, the Auto setting determines the correct colorspace to use. If it does not, you can choose a specific colorspace:

Choose from **Auto**, **YPbPr**, **YCbCr**, **RGB PC** and **RGB Video**.

Color	
Color Space	Auto
Color Mode	Auto
ColorMax	YPbPr
Manual Color Matching	YCbCr
Color Temperature	RGB PC
Gains and Lifts	RGB Video

Notes

 **Color Space** is not available with HDMI 3 or HDMI 4.

Color mode

The projector can work in the following color modes: **ColorMax**, **Manual Color Matching**, **Color Temperature** and **Gains and Lifts**.

Color	
Color Space	Auto
Color Mode	ColorMax
ColorMax	ColorMax
Manual Color Matching	Manual Color Matching
Color Temperature	Color Temperature
Gains and Lifts	Gains and Lifts

Notes



Only one color mode can be selected at a time. Settings used by the other color modes are disabled.

ColorMax

1. Set **Color Mode** to **ColorMax**.
2. Navigate to the **ColorMax** setting.
3. Choose from **HDTV**, **Peak**, **User 1** and **User 2**. **User 1** and **User 2** are user-defined color gamuts set via the **Setup > ColorMax** menu.

Color	
Color Space	Auto
Color Mode	ColorMax
ColorMax	Peak
Manual Color Matching	HDTV
Color Temperature	Peak
Gains and Lifts	User 1
	User 2



See Setup menu on page 83 for further information about setting up the **User 1** and **User 2** color gamuts.

Manual color matching

1. Set **Color Mode** to **Manual Color Matching**.
2. Open the **Manual Color Matching** submenu.

Here you can do the following:

- Switch **Auto Test Pattern On** and **Off**.
- Adjust **Hue, Saturation and Gain** settings for each individual color to improve the color balance of the projected image.
- Adjust white balance RGB values.
- Reset all values.

Manual Color Matching

Auto Test Pattern	Off	▶
Red		▶
Green		▶
Blue		▶
Yellow		▶
Cyan		▶
Magenta		▶
White Balance		▶
Reset		

Manual Color Matching - Red

Hue	100	<input type="range" value="100"/>
Saturation	100	<input type="range" value="100"/>
Gain	100	<input type="range" value="100"/>

Manual Color Matching - White

Red	100	<input type="range" value="100"/>
Green	100	<input type="range" value="100"/>
Blue	100	<input type="range" value="100"/>

Notes

See Color matching parameters explained on the facing page for more details about the Hue, Saturation and Gain settings.



Color matching parameters explained

The levels of hue, saturation and gain in the Manual Color Matching menu change the color values in the following ways:

1. **Hue** Specifies the position of each color (red, yellow, green, cyan, blue and magenta) relative to its neighboring colors.
2. **Saturation** Specifies the level of white in each color (i.e. how "pale" each color is).
3. **Gain** Controls the amount of light that goes into each color, i.e. the lowest gain would produce black.

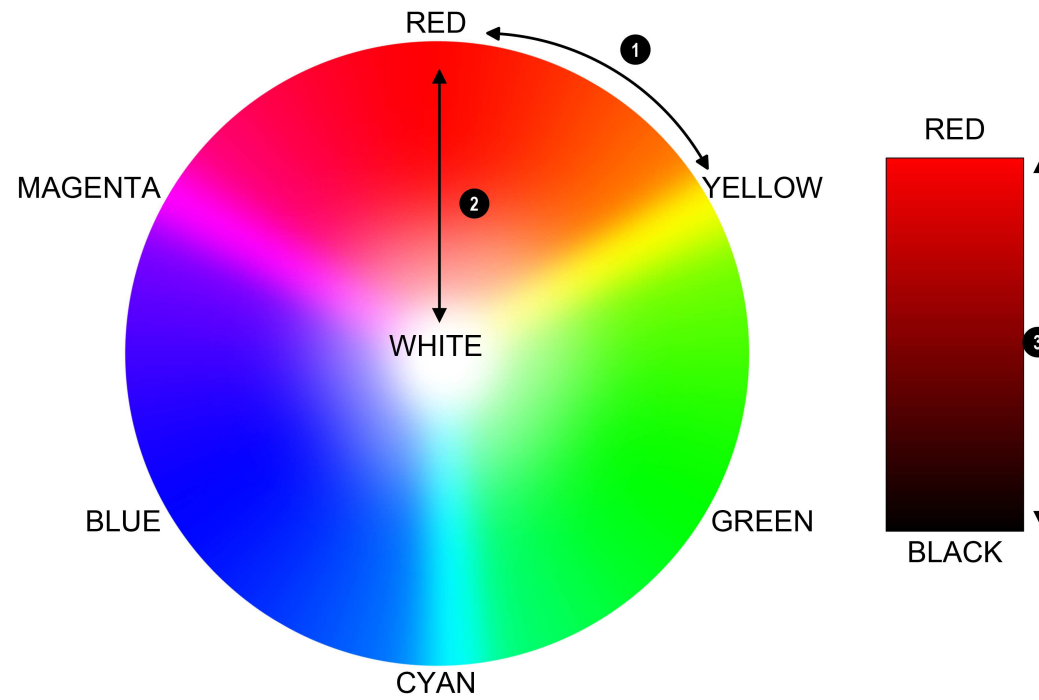

Notes

Color temperature

1. Set **Color Mode** to **Color Temperature**.
2. Navigate to the **Color Temperature** setting. Choose a value from **3200K** (warmer) to **9300K** (cooler) or **Native** (no correction).

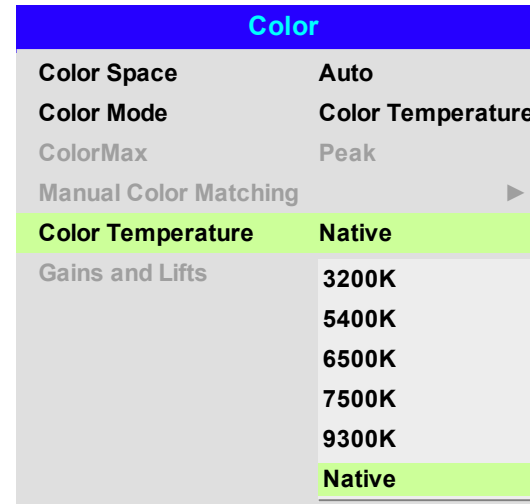

Gains and lifts

1. Set **Color Mode** to **Gains and Lifts**.
2. Open the **Gains and Lifts** submenu.

Lifts allow you to adjust black levels of individual colors, while gains adjust the bright part of the scale.

Set the sliders as required



Notes

Geometry menu

This menu allows you to compensate for image distortions caused by an unusual projection angle or irregular screen surface.

Geometry	
Aspect Ratio	Source
Digital Zoom	▶
Overscan	Off
Blanking	▶
Warping Mode	Keystone
Keystone	▶
4 Corners	▶
Rotation	▶
Pincushion / Barrel	▶
Arc	▶
Custom Warp	▶

Notes

 **Aspect Ratio, Digital Zoom and Overscan** are not available with input HDMI 3 or HDMI 4.

 Select a **Warping Mode** to activate it. Access its submenu to adjust the warping mode settings.

Aspect ratio

This feature defines the aspect ratio of the source. Use the **Setup > Screen Setting** to define the screen aspect ratio.

If you choose a preset aspect ratio from here, it will give you the best fit for your selection.

Choose from:

- 5:4
- 4:3
- 16:10
- 16:9
- 1.88
- 2.35
- TheaterScope
- Source
- Unscaled

 Image scaling and aspect ratio are also influenced by **Setup > Screen Setting**.

 See **TheaterScope** setting on the next page for further information about the **TheaterScope** aspect ratio.

Theaterscope setting

The **TheaterScope** setting is used in combination with an anamorphic lens to restore 2.35:1 images packed into a 16:9 frame. Such images are projected with black lines at the top and bottom of the 16:9 screen to make up for the difference in aspect ratios.

Without an anamorphic lens and without the TheaterScope setting applied, a 16:9 source containing a 2.35:1 image looks like this:

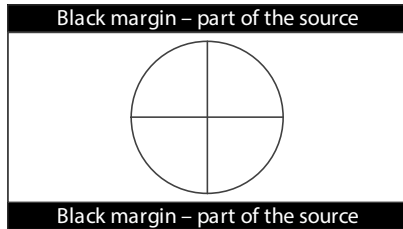

If we change the setting to TheaterScope, the black lines will disappear but the image will stretch vertically to reach the top and bottom of the DMD™:

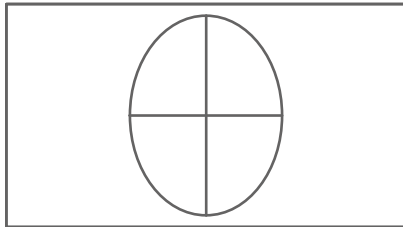

An anamorphic lens will stretch the image horizontally, restoring the original 2.35 ratio:

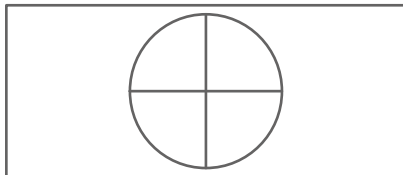

Notes

 TheaterScope is used with an anamorphic lens.

 If you use TheaterScope, set your screen aspect ratio to 16:9.

Digital zoom

Digital zooming enlarges a section of the image, while the area outside the enlarged section is cropped out to preserve the overall image size.

- **Digital Zoom** defines the level of zoom that needs to be applied. If **Digital Zoom** is set to 0, then the other settings in the menu will be disabled.
- **Digital Pan** and **Digital Scan** specify the area that is being enlarged:
 - **Digital Pan** adjusts the horizontal coordinates.
 - **Digital Scan** adjusts the vertical coordinates.

The **Reset** command restores the default **Digital Zoom**, **Digital Pan** and **Digital Scan** values.

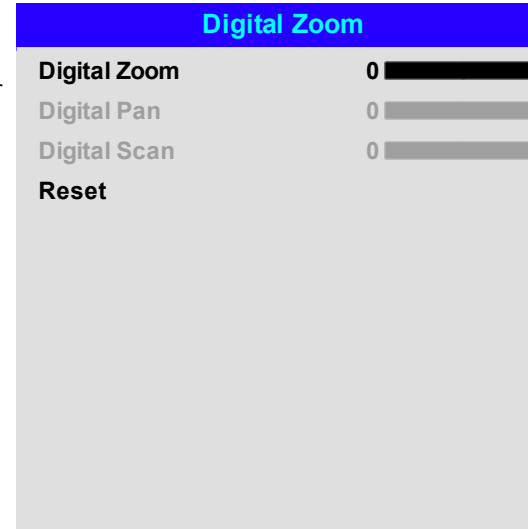

Notes

 **Digital Zoom** is not available with input HDMI 3 or HDMI 4.

 **Digital Zoom** is a temporary setting and not retained after an input change or power cycle.

Overscan

Use this setting to compensate for noisy or badly defined image edges.

Crop removes unwanted artifacts from the edges of your image by cropping the edges.

Zoom increases the size of the image to force the edges off-screen

Geometry	
Aspect Ratio	Source
Digital Zoom	▶
Overscan	Off
Blanking	Off
Warping Mode	Crop
Keystone	Zoom
4 Corners	
Rotation	▶
Pincushion / Barrel	▶
Arc	▶
Custom Warp	▶

Notes

 **Overscan** is not available with input HDMI 3 or HDMI 4.

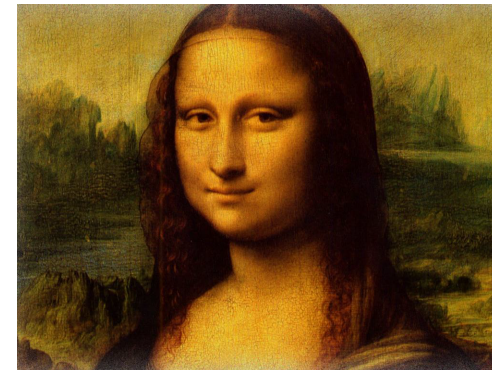
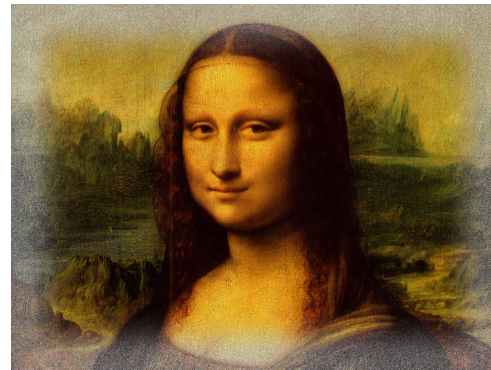

Blanking

Use this feature to:

- fit an odd-sized screen;
- cut off timecode dots in the top line of a picture;
- cut off subtitles, etc.

Select the edge you wish to blank and use the **LEFT** and **RIGHT** arrow buttons to determine the amount of correction.

Use the **Reset** command to restore blanked edges.

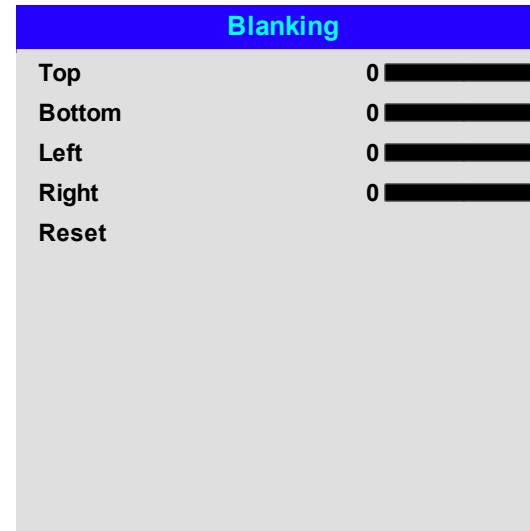

Notes

Keystone

Use this setting to compensate for any distortion caused by the projector being in a different horizontal or vertical plane to the screen.

After correcting for keystone, the aspect ratio of the projected image may be incorrect. This is dependent upon the throw ratio of the lens at its current zoom setting. Adjust the lens throw ratio to compensate for the aspect ratio that results from the zoom setting on the lens.

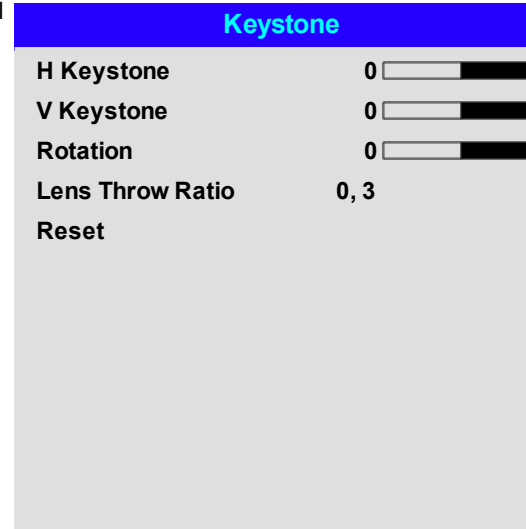

Keystone	
H Keystone	0
V Keystone	0
Rotation	0
Lens Throw Ratio	0, 3
Reset	

Notes



Max rotation in Keystone is reduced from normal rotation



Make sure that the lens type is set to the correct lens in the lens menu before adjusting the lens throw ratio

Keystone example

The projector is positioned at an angle

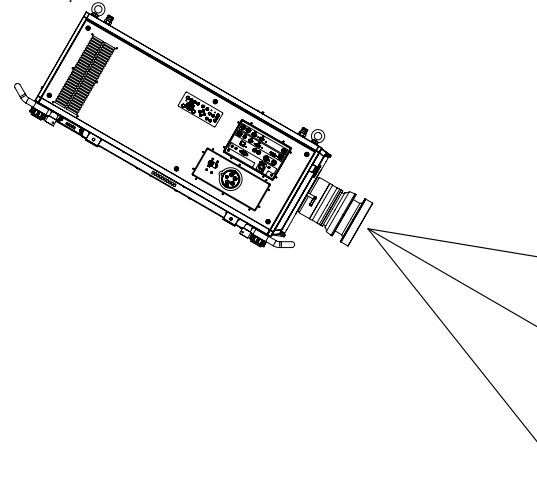

The resulting image is distorted



The image is corrected when Keystone is applied, but the aspect ratio is incorrect



The aspect ratio is corrected when the correct lens throw ratio is applied



Notes

Keystone settings

1. **Projector to the left** The projector is positioned to the left of the screen. To correct, apply a positive **Horizontal Keystone** value using the **RIGHT** arrow button.
2. **Projector to the right** The projector is positioned to the right of the screen. To correct, apply a negative **Horizontal Keystone** value using the **LEFT** arrow button.
3. **Projector high** The projector is positioned above the screen at a downward angle. To correct, apply a negative **Vertical Keystone** value using the **DOWN** arrow button.
4. **Projector low** The projector is positioned below the screen at an upward angle. To correct, apply a positive **Vertical Keystone** value using the **UP** arrow button.
5. **Projector straight** The projector is directly opposite the screen at a right angle both horizontally and vertically. No correction is needed.

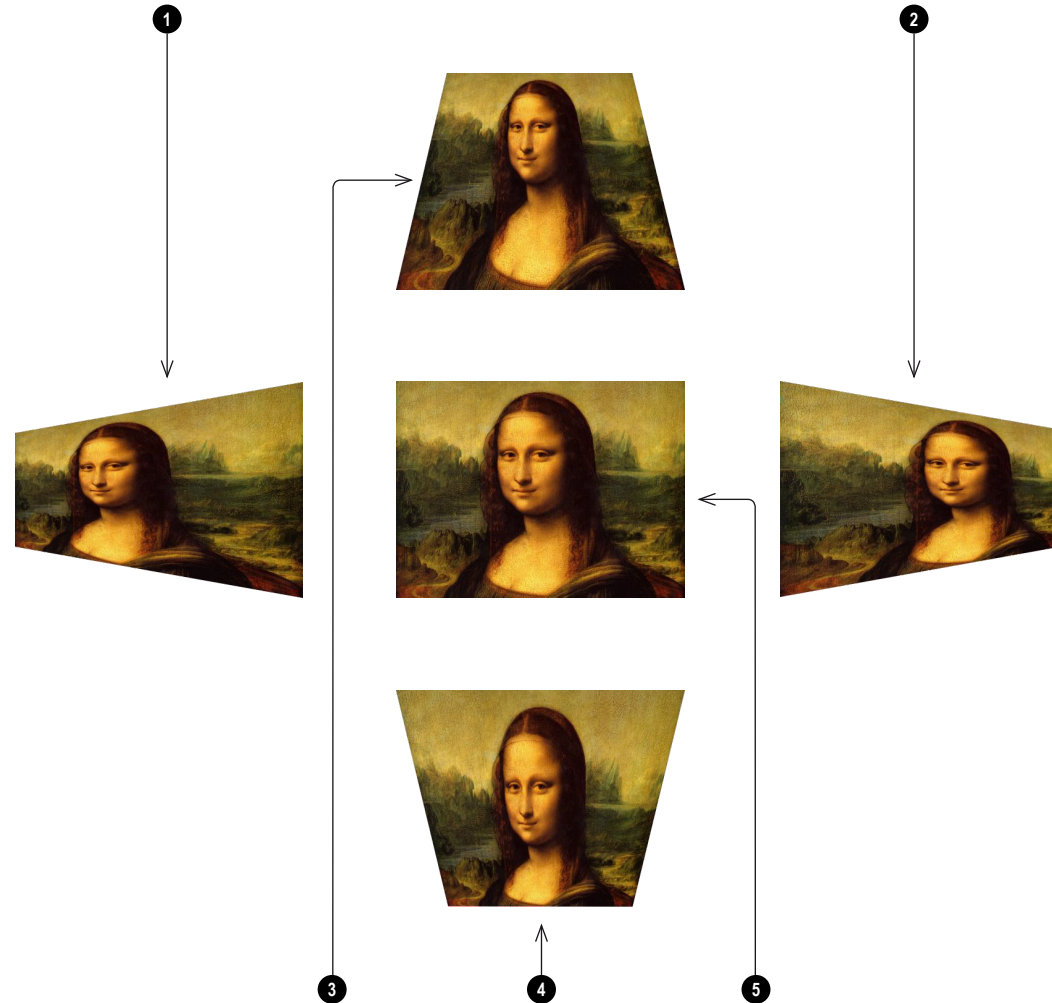

Horizontal and vertical keystone corrections

Notes

4 corners

For each corner, apply horizontal and / or vertical correction as necessary to restore the rectangular shape of the image.

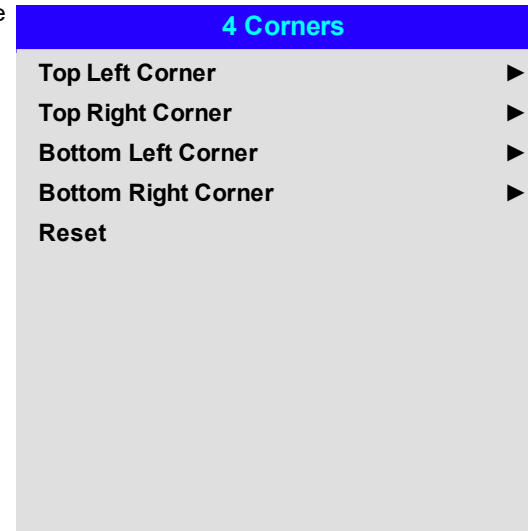

Notes

*Corner corrections provide a simple setup for awkward installations and irregular shaped screens that may distort the image. To apply a similar (but less flexible) correction, while preserving the original aspect ratio of the image, use the **Keystone** menu.*

Top right corner example

In this illustration, the top right corner requires both horizontal and vertical correction.

Top Right Corner Adjustment

Top Right Corner x ◀ 0 ▶

Top Right Corner y ▲ 0 ▼

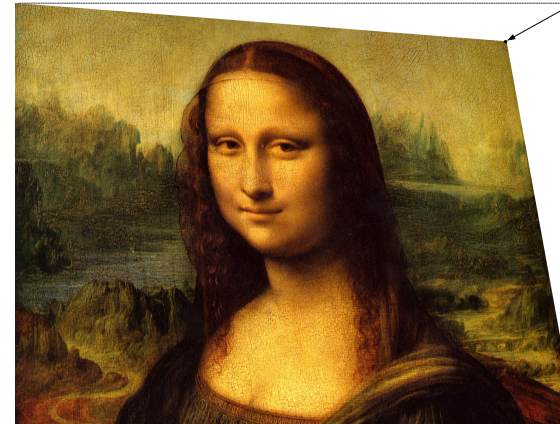

Notes

Rotation

Use this feature for example to correct a mounting error causing the image not to be level with the screen.

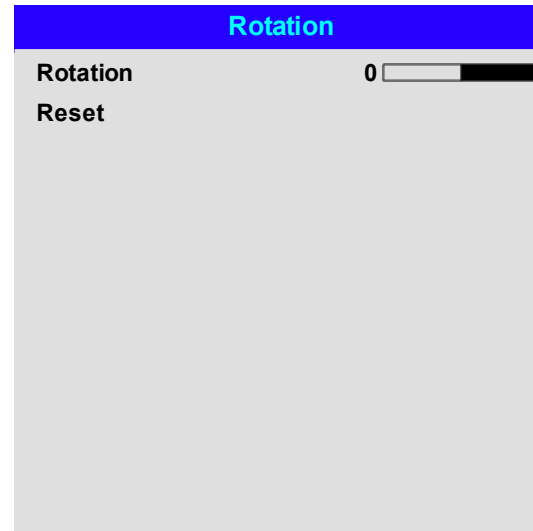

Notes

Rotation example

- 1. DMD™ area**
The DMD™ is not rotated. It still covers the area that would be occupied by the image without correction.
- 2. Rotated image**
The image is smaller than the surrounding DMD™ area. It is scaled in order to remain within the DMD™ area.
- 3. Angle of rotation**
Each step on the slider is 0.25° of rotation. In this example the angle is 5° , therefore Rotation value is 20.

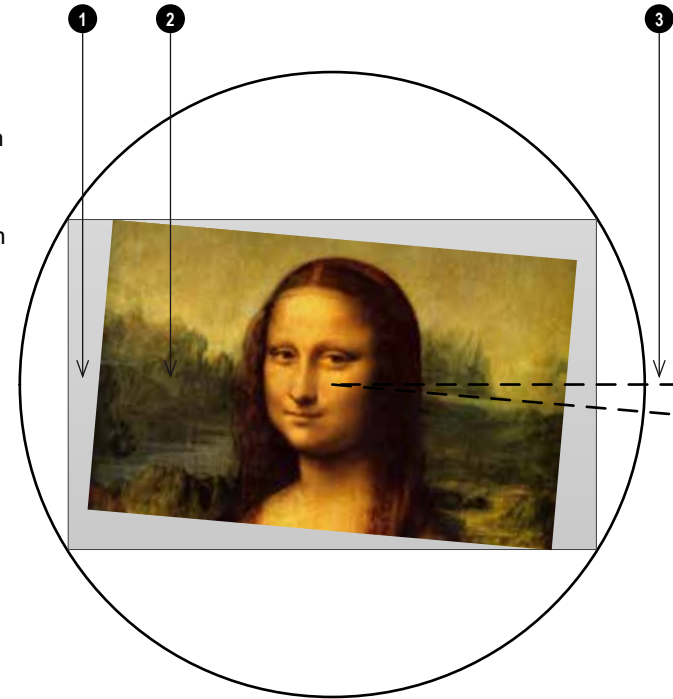
**Notes**

Pincushion / barrel

Pincushion or barrel distortions are the result of poor or incorrect tensioning of the screen or using a surface that is not flat.

Use the **Pincushion / Barrel** control to compensate electronically for such distortions.

You can also use this menu to make simple panoramic screen corrections without using external processors.

When also correcting for keystone, the aspect ratio of the projected image may be incorrect. This is dependent upon the throw ratio of the lens at its current zoom setting. Adjust the lens throw ratio to compensate for the aspect ratio that results from the zoom setting on the lens.

Pincushion / Barrel	
H Pin/Barrel	0 <input type="range"/>
V Pin/Barrel	0 <input type="range"/>
Keystone	<input type="range"/>
Lens Throw Ratio	, 3
Reset	

Notes

Make sure that the lens type is set to the correct lens in the lens menu before adjusting the lens throw ratio

Pincushion/ Barrel example

The illustration shows pincushion and barrel correction applied both horizontally and vertically, in equal measures.

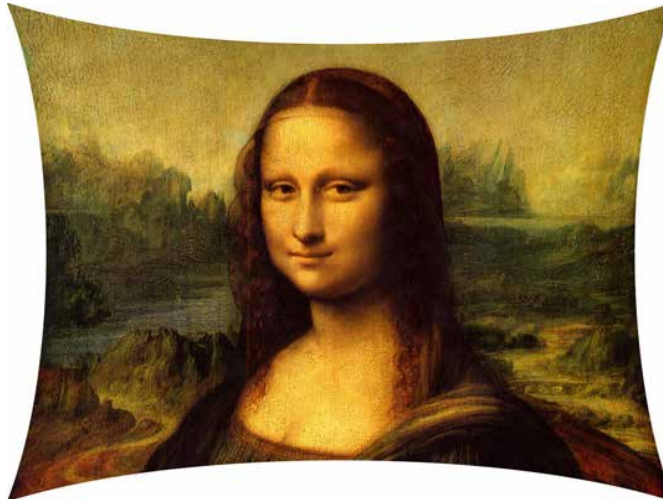

Pincushion



Barrel

Arc

This feature is similar to **Pincushion / Barrel** but allows you to apply curvature to each edge of the image independently so you can have any combination of corrections.

Arc	
Top	0 <input type="range"/>
Bottom	0 <input type="range"/>
Left	0 <input type="range"/>
Right	0 <input type="range"/>
Reset	



Notes

*Please note that a positive **Arc** value on any edge will reduce the image size as the projector needs to maintain the aspect ratio. A negative **Arc** value will not affect the overall image size.*

Custom warp

This feature permits selection of predefined User warp maps. Use the Projector Controller PC application to create the custom warp maps.

Custom warp maps provide non-linear curvature correction for curved or spherical screens and other irregular shaped surfaces such as building mapping.

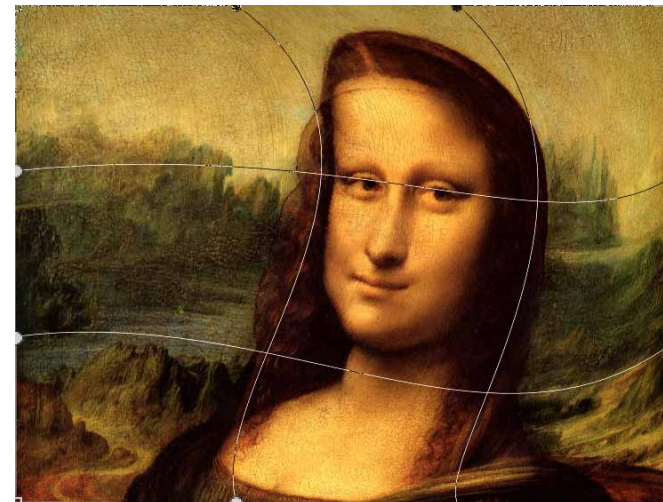
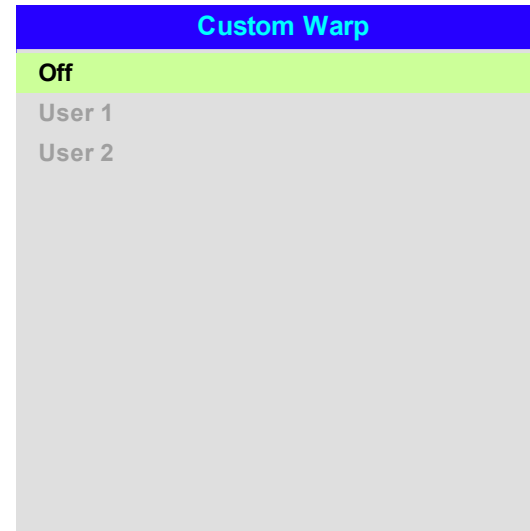

Notes

Edge blend menu

Use this menu to blend together images from an array of two or more projectors. The feature feathers the light output of the projector within the edges that overlap with other projectors in the array: as a result, the overlapping edges are evenly lit and easily blend in with the rest of the image.

- **Edge Blend**
Enable and disable **Edge Blend**
- **Align Pattern**
Add markers to the image showing the edges of the blend area and making the overlaps more visible to help adjust the physical position of the projectors in the array.
- **Blend Start**
Determine the start point of the blended regions. top, bottom, left right
- **Blend Width**
Determine the width of the blended regions.
- **Black Level Uplift**
Adjust black levels to compensate if the blended regions appear brighter than the rest of the image.
- **Reset**
Reset all **Edge Blend** settings to their factory default values.

Edge Blend	
Edge Blend	On
Align Pattern	Off
Blend Start	▶
Blend Width	▶
Black Level Uplift	▶
Reset	

Notes

 When **Edge Blend** is set to **Off**, all other edge blend settings are disabled.

 The picture in the blend region needs to be delivered to all overlapping projectors, which may require a special setup of the source.

Blend start

Use the blend start options to deactivate pixels at the edge of the image and set the start point for the blended region. Use the **LEFT** and **RIGHT** arrow buttons to set the start point of the blended regions:

1. Top
2. Bottom
3. Left
4. Right

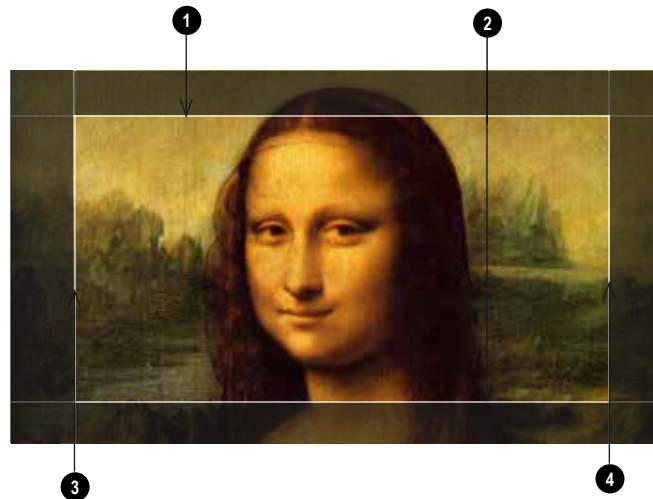
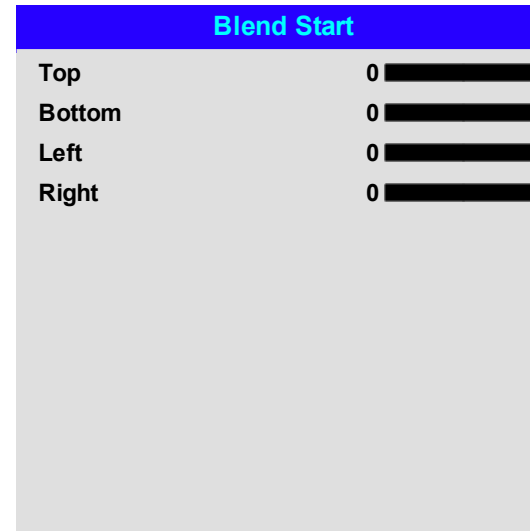

Notes

Blend width

Use the **LEFT** and **RIGHT** arrow buttons to set the width of the blended regions:

1. Top
2. Bottom
3. Left
4. Right

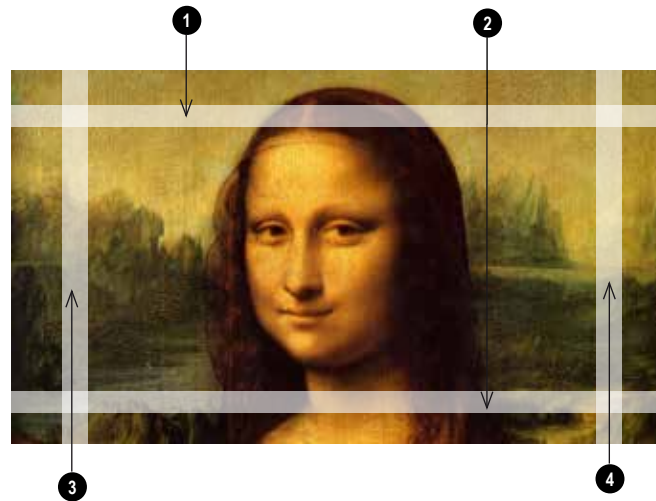

Notes

Black level uplift

Black in the blended regions appears less dark than in the rest of the image. To compensate for this, use this menu to raise the black levels of the rest of the image:

- Set **All** to the required amount of black level correction. This will apply equal correction to the black levels of all colors
- If necessary, use the individual color sliders (**Red**, **Green** and **Blue**) for fine adjustment.

You may experience artifacts at the edges where the blended region of one projector overlaps the *pond of mirrors* of its neighbor. In the example below, the blended image comes from *two projectors*, ① and ②. Both images have black level uplift applied; as a result, *artifacts* ③ and ④ have emerged at the edges where the black level uplift region of one projector overlaps the pond of mirrors of the other.

To remove the artifacts, you need to slightly reduce the size of the black level uplift region of each projector so it does not overlap the pond of mirrors of the other projector.

- Depending on your array, use **Top**, **Bottom**, **Left** and/or **Right** to reduce the black level uplift size. In the example below, use the **Right** slider of the **projector on the left** ① to remove the *artifact on the right* ④, and the **Left** slider of the **projector on the right** ② to remove the *artifact on the left* ③.

Black Level Uplift

Select Area	
Top	0 <input type="range"/>
Bottom	0 <input type="range"/>
Left	0 <input type="range"/>
Right	0 <input type="range"/>
Color Adjustment	
All	◀ ▶
Red	0 <input type="range"/>
Green	0 <input type="range"/>
Blue	0 <input type="range"/>

Notes

Enable **Align Pattern** from the **Edge Blend** menu to see the black level uplift area.

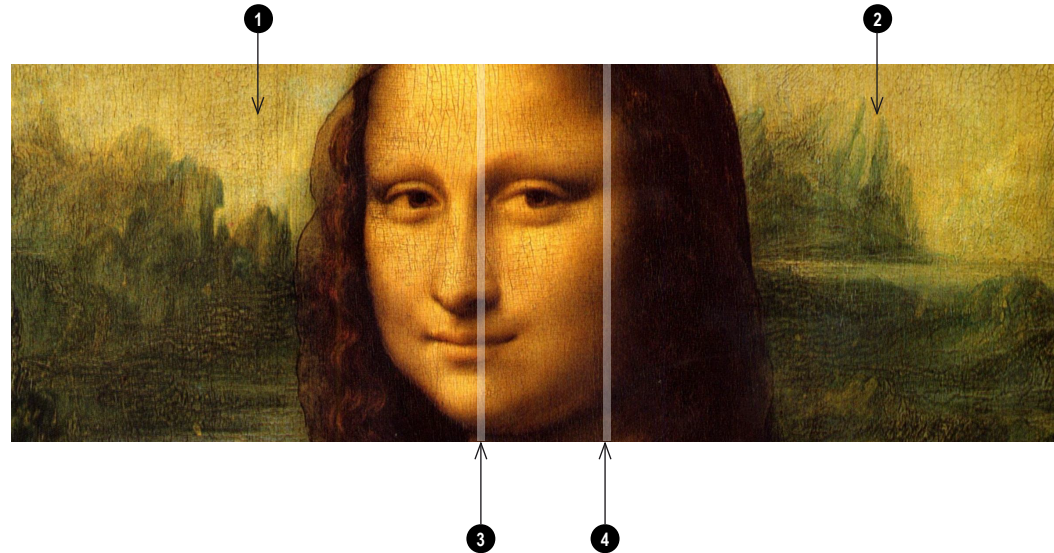

3D menu

Use this menu to enable, disable and set up 3D input, as follows:

- 3D Format
Off, Dual Pipe and Frame Sequential.
Frame Sequential is for sources where Left and Right eye images are delivered as alternate frames from a single input. **Dual Pipe** is for sources where Left and Right eye are delivered on separate inputs.
- Eye Swap
Normal and Reverse.
(set to **Reverse** if the left- and right-eye images are displayed in the wrong order)
- Dark Time
0.65 ms, 1.3 ms and 1.95 ms.
Set to reduce the effect of banding and image overlapping when viewed through 3D glasses.
- **Sync Offset.**
Use the **LEFT** and **RIGHT** arrow buttons to compensate for image overlapping (ghosting) when viewed through 3D glasses.
- Sync Reference
External and Internal.
Select the source of the 3D sync. Internal is referenced to the incoming video. External is for Frame Sequential 3D sources and is supplied by the graphics card or player.

3D	
3D Format	Auto
Eye Swap	Normal
Dark Time	1.95 ms
Sync Offset	100 <input type="range"/>
Sync Reference	Internal

Notes

 3D video is only possible on the HDMI 3 and HDMI 4 inputs.

 If **3D Format** is set to **Off**, all other 3D settings will be unavailable.

 See 3D connections on page 38 for more information about supported 3D formats.

The following settings are not available when 3D is on:

Image > Brightness, Contrast, Saturation, Hue, Sharpness, Noise Reduction, Freeze,

 **Resync.**

Color > Color Space.

Geometry > Aspect Ratio, Digital Zoom, Overscan.

Setup > Screen Setting, Auto Source, Trigger-1, Trigger-2.

PIP > all settings.

 Also: See 3D types on the facing page and See Some 3D settings explained on page 80

 See 3D formats on page 124 for 3D resolutions and frame rates.

3D types

To display a 3D image if is first necessary to select the 3D format. This can either be Frame Sequential or Dual Pipe. These formats are described below:

- **Dual Pipe (LEFT and RIGHT)** The left and right eye images are delivered on two separate HDMI links, which the projector will interleave for 3D display.
- **Frame Sequential** For sequential 3D, an external sync is required to identify left and right frames. If no sync is available from the sequential source, the projector will generate an output sync, but it may then be necessary to manually set the Eye Swap each time the player is started.

Dark Time and **Sync Offset** need to be set only once, to optimize the image for the glasses in use.

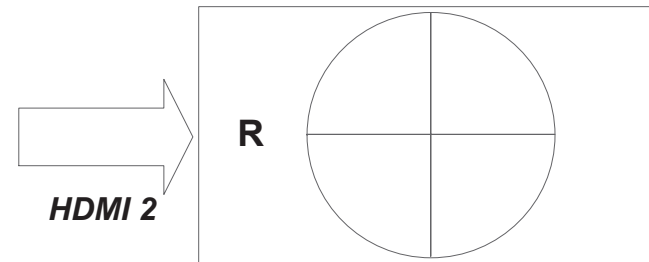
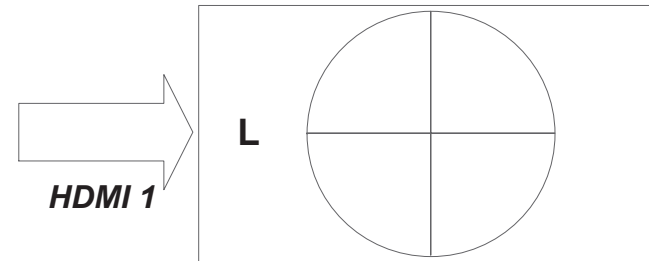

Dual Pipe

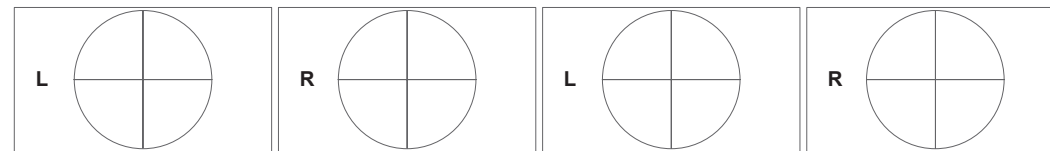

Sequential

Notes

Some 3D settings explained

Dark time

Banding can be caused if the image is displayed before each eye of the 3D switching glasses or ZScreen is not fully open. **Dark Time** allows you to minimize this effect.

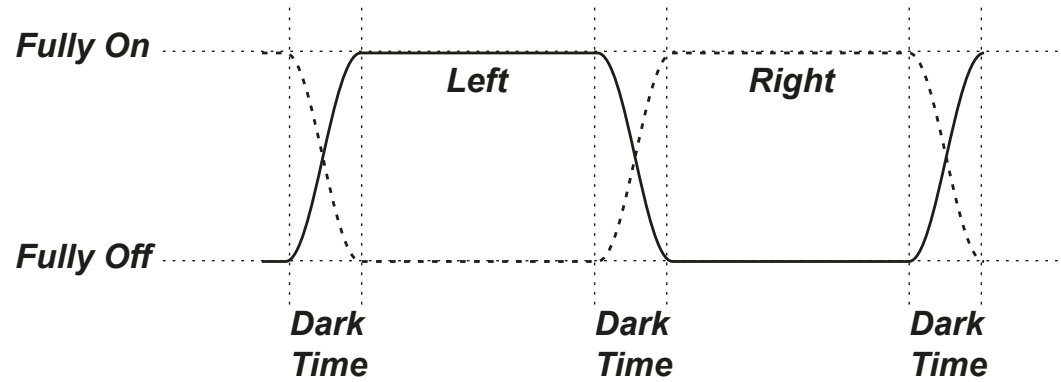

Eye swap

The outgoing 3D frames are in pairs - the dominant frame being presented first. You can determine which frame should be the dominant one.

By convention the default setting is **Left**.

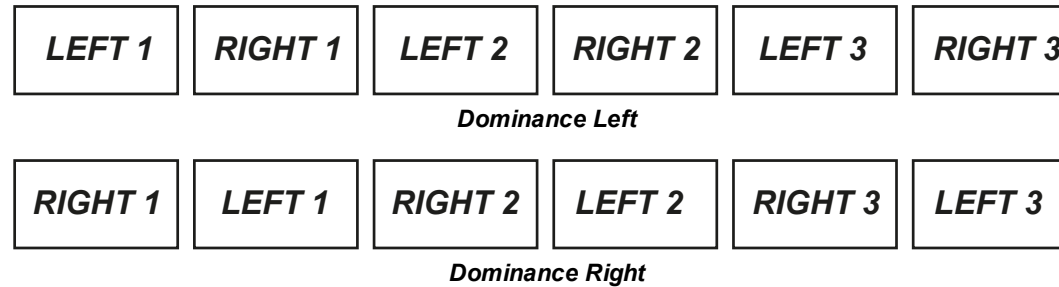

Notes

In order to achieve maximum light output and a smooth grayscale, whilst eliminating ghosting, the following procedure is recommended:

- 1.** Set **Dark Time** to a value appropriate to the glasses or ZScreen, say 1.3 ms or 1.95 ms.
- 2.** Adjust **Sync Offset** time to eliminate ghosting and achieve a smooth grayscale.
- 3.** Repeat steps 1 and 2 until the best result is obtained.



Sync offset

The sync signal from the 3D server will be in phase with the frames generated by its graphics card. However, to compensate for switching delays in the glasses or ZScreen, **Sync Offset** is used to adjust the sync output signal sent to the ZScreen or 3D glasses to minimise overlapping (ghosting in the image when viewed through the 3D glasses).

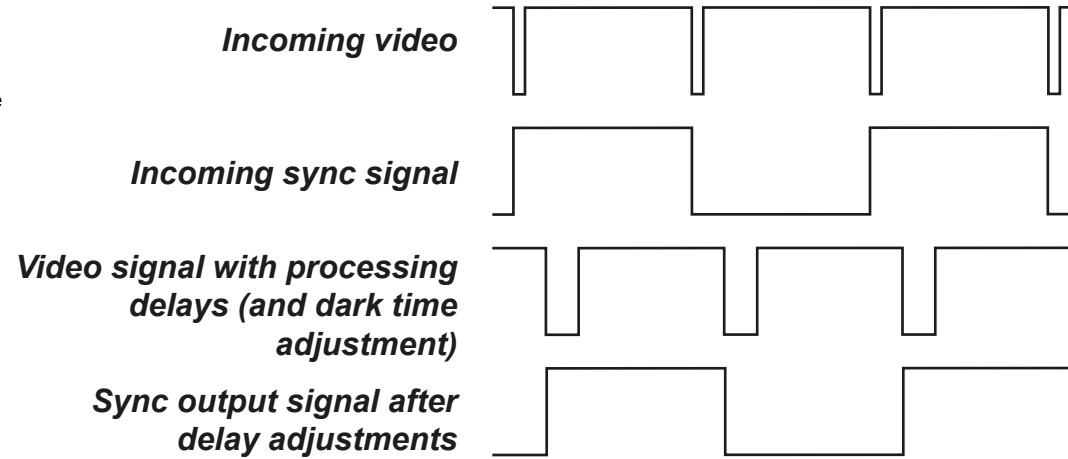
**Notes**

Laser menu

- **Power Mode**

- **Eco** will automatically set the laser power to 80%.
- **Normal** will set the power to 100%.
- Set to **Custom** if you wish to adjust the power manually.

- **Power Level**

This setting is only available if **Power Mode** is set to **Custom**.

Choose a value between 30 and 100, ranging from 30% to 100% laser power.

- **Constant Brightness**

Once a **Custom Power Mode** has been set, then Constant Brightness can be turned **ON**.

This setting will maintain the brightness until the maximum laser power has been reached. The lower the power level the longer it will be maintained.

- **MUBC (Multi Unit Brightness Correction)**.

MUBC is available when multiple projectors are synchronised.

Over time, the output power of the lasers in the projector will diminish. The output power of the lasers in different projectors may diminish at different rates. When multiple units are synchronised, this can lead to different units operating at different laser power levels, causing the projected images to display at differing brightnesses.

MUBC groups multiple projectors together to make sure that the lasers in each projector always operate at the same power level. The power level will automatically adjust to match the lowest power level in the group.

1. **MUBC Mode**

Choose master or slave. The master projector is the first projector in a group. There is only one master projector in a group. Up to 8 projectors are slaved to the master projector

2. **MUBC Group**

Choose the group the projector belongs to

3. **MUBC Refresh Interval**

Sets the time between laser power level updates

- **MUBC Status**

Open the MUBC Connection Status menu to view the connection information for the projector

Laser	
Power Mode	Normal
Power Level	----
Constant Brightness	Off
MUBC Mode	Off
MUBC Group	----
MUBC Refresh Interval	---- (Min)
MUBC Connection Status	▶

Notes





The projector must be connected via LAN to the same network group as other projectors to allow MUBC

Setup menu

- **Orientation**
Choose from **Front Tabletop**, **Front Ceiling**, **Rear Tabletop**, **Rear Ceiling** and **Auto-front**.
- **High Altitude**
Choose from **On**, **Auto** and **Quiet**.
- **Standby Mode**
Choose from **SuperECO**, **ECO** and **Normal**.
SuperECO uses minimal power and disables power ON via LAN.
ECO uses a low power setting but enables power ON via Ethernet port only.
Normal enables power ON via both HDBase-T/LAN and Ethernet ports.
- **Screen Setting**
Choose from **16:10**, **16:9** and **4:3**.
- **ColorMax Setting**
Set up user-defined color gamut values.
- **Power On/Off Management**
Access the submenu to set up automatic projector power on and power off.
- **Clock Adjust**
Access the submenu to set current date and local time.
- **Startup Logo**
Choose from **Off**, **Original** and **User**.
Select original to display the Digital Projection Ltd. logo on startup. Select User to display a custom logo. Use the custom logo upload tool to set the custom logo for the User option.
- **Blank Screen**
Choose from **Logo**, **Black**, **Blue** and **White**.
- **Auto Source**
If this setting is **On**, the projector will automatically search for an active input source.
- **PIC Mute Setting**
Access sub menu to set up the picture mute control.

Setup	
Orientation	Auto-front
High Altitude	Auto
Standby Mode	Normal
Screen Setting	16:10
ColorMax Setting	▶
Power on/off Management	▶
Clock Adjust	▶
Startup Logo	Original
Blank Screen	Logo
Auto Source	Off
PIC Mute Setting	▶
▼	

Notes

-  **Auto-front** automatically detects the projector's position and sets Table or Ceiling orientation accordingly.
-  **Screen Setting** and **Auto Source** are not available with input HDMI 3 or HDMI 4
-  **Custom Logo**. Please request the Custom Logo Upload Tool from your local Digital Projection Service provider to upload a custom logo.

Highlight the **DOWN** arrow at the bottom of the page and press **ENTER/OK** to navigate to the second Setup menu page.

- **Trigger1 and Trigger 2**

Choose from **Screen, 5:4, 4:3, 16:10, 16:9, 1.88, 2.35, TheaterScope, Source, Unscaled** or **RS232** to determine what will cause each trigger output to activate.

- **Infrared Remote**

Set to **Off** if you wish to disable the remote control.

- **IR Code**

The projector and the remote control need a matching IR code: a two-digit number between **00** and **99**. The default IR code is **00**. This is also a master code, which, if assigned to a remote, will work regardless of the value assigned to the projector.

- **To assign an IR code for the projector:** Select IR code. Use the UP and DOWN arrow buttons to change the values.
- **To assign an IR code for the remote,** press and hold the **ADDR** button on the remote until the On indicator starts flashing. Release the **ADDR** button and while the indicator is still flashing, enter a two digit address using the numeric input buttons. The indicator will flash three times quickly to confirm the change.

- **IR Code Reset**

Use this command to unassign an IR code from the projector. This will revert the **IR Code** value to 00.

To unassign an IR code from the remote control, press and hold **ALT** and **ADDR** simultaneously until the On indicator flashes to confirm the change.

- **OSD Settings**

Access this submenu to adjust the appearance and position of the on-screen display.

- **Memory**

Access this submenu to save up to four presets containing custom combinations of image settings, or to recall a saved preset.

- **Instant Startup**

When **ON** only the Laser will be turned off when the Power off command is given. A subsequent Power On will turn on the laser giving an apparent very fast power on.

- **Standby Period**

Used with Instant Startup. If Instant Startup in **ON** and the projector is powered down then the projector will go to Standby after the selected "Standby Period" 30 minutes, 60 minutes, 90 minutes.

- **EDID Mode**

Access this submenu to set the frame rate and display resolution for each input type.

Setup	
	▲
Trigger-1	Off
Trigger-2	Off
Infrared Remote	On
IR Code	0
IR Code Reset	
OSD Settings	▶
Memory	▶
Instant Startup	Off
Standby Period	30 Min.
EDID Mode	▶
	▼

Notes

 **Trigger-1 and Trigger-2** are not available with input HDMI 3 or HDMI 4. If you turn the remote control off, you can only turn it back on again from the control panel or via the **Projector Controller** application.

 The **Projector Controller** software is available for download from the Digital Projection website, free of charge.

 A wired remote control will also be disabled if **Infrared Remote** is set to **Off**.

Highlight the **UP** arrow at the top of the page and press **ENTER/OK** to go back to the first **Setup** menu page. Highlight the **DOWN** arrow at the bottom of the page and press **ENTER/OK** to navigate to the third Setup menu page.

- **Hotkey Setting**

Access this submenu to set the option for each hotkey.

- **Keypad Button Backlight**

Choose from **On** or **Off**. Select On to switch the keypad backlight on. This will light the keypad controls on the projector.

- **Smear Reduction**

Choose from **Off**, **6ms**, **7ms**, **8ms**, **9ms**, and **10ms**. When projecting footage with a high frame rate, fast moving images may appear as a smear across the display. Select a smear reduction value to reduce this effect.

- **Output Frame Rate**

Choose from **Auto**, **48Hz**, **50Hz** and **60Hz**. Select Auto to use the same frame rate as the input signal. When switching between inputs on auto output frame rate, the projector measures the input frame rate before setting the output frame rate. When you know that all input frame rates are the same value, you can set an output frame rate to reduce the time it takes to switch between inputs.

Highlight the **UP** arrow at the top of the page and press **ENTER/OK** to go back to the second **Setup** menu page.

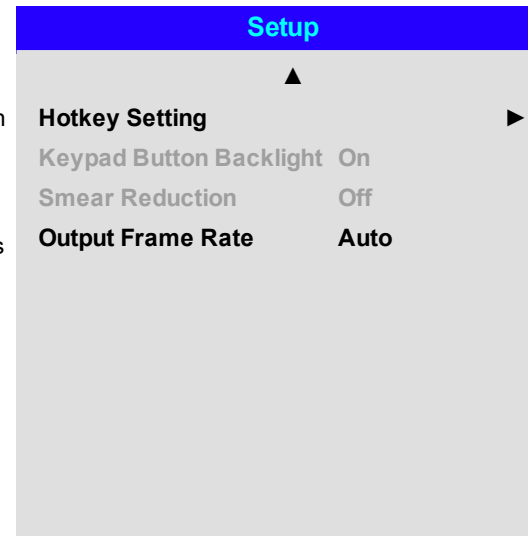

Notes

 **Smear reduction** is not available for 3D input types

 **Smear reduction** reduces the brightness of the displayed image

ColorMax

ColorMax permits seven point color matching of red, green, blue, yellow, cyan, magenta and white.

You can enter your own gamut values here, or edit values you have imported using the **Projector Controller** software.

Defining your own colorspace with individual x and y coordinates for each color enables you to match not only the whites but each individual color as well.

Highlight the submenu you wish to open and press **ENTER/OK** to confirm your choice.



 **The Projector Controller** software is available for download from the Digital Projection website, free of charge.

 This tool is best used in conjunction with a specialized light meter (a photo spectrometer) to measure color parameters within a particular installation. However, the preloaded generic factory default data set is designed to give more than satisfactory results.

Measured data/ target data

1. Use the **UP** and **DOWN** arrow buttons to highlight a color, then use the **LEFT** and **RIGHT** arrow buttons to navigate to the x or y coordinate.
2. Use the **UP** and **DOWN** arrow buttons to increase and decrease the value, respectively.
3. Exit edit mode:
 - press **ENTER/OK**, if you want to save the edited values.
 - press **EXIT**, if you do not wish to save the edited values
4. If necessary, highlight another color and repeat the procedure.

Measured Data	
Red	x: 0.658 y: 0.339
Green	x: 0.315 y: 0.662
Blue	x: 0.146 y: 0.043
White	x: 0.276 y: 0.283
Reset	

Target Data - User1	
Red	x: 0.640 y: 0.390
Green	x: 0.300 y: 0.600
Blue	x: 0.150 y: 0.060
Yellow	x: 0.419 y: 0.505
Cyan	x: 0.225 y: 0.329
Magenta	x: 0.321 y: 0.154
White	x: 0.285 y: 0.302

Notes

Power on / off

- **Auto Power Off**

Set this to **On** if you want the projector to go into STANDBY mode when no input source is detected for 20 minutes.

- **Auto Power On**

Set this to **On** if you want the projector to start up immediately when the mains is connected. Set this to **Off** if you want the projector to go into STANDBY mode when the mains is connected. In this case, the projector will not start up until the **POWER** button is pressed on the control panel or the **ON** button is pressed on the remote control.

- **Scheduled on/off**

Access this submenu to create a weekly schedule for automatic on and off times:

1. Set a schedule:

- Use the **UP** and **DOWN** arrow buttons to highlight a row, then press **ENTER/OK** to enable edit mode.
- Within a row, navigate with the **LEFT** and **RIGHT** arrow buttons. Set values with the **UP** and **DOWN** arrow buttons.
- To exit edit mode, press **ENTER/OK**. Alternatively, press **EXIT** if you don't want the changes to take effect. Move to another row using the **UP** and **DOWN** arrow buttons.

2. To enable the schedule, set Schedule to **On**.

Power on/off Management

Auto Power Off	Off
Auto Power On	Off
Scheduled on-off	▶

Scheduled on-off

	Schedule							Off	Time
	S	M	T	W	T	F	S		
On	<input checked="" type="checkbox"/>	<input type="checkbox"/>	<input type="checkbox"/>	<input type="checkbox"/>	<input type="checkbox"/>	<input type="checkbox"/>	<input type="checkbox"/>	12:34	
Off	<input checked="" type="checkbox"/>	<input type="checkbox"/>	<input type="checkbox"/>	<input type="checkbox"/>	<input type="checkbox"/>	<input type="checkbox"/>	<input type="checkbox"/>	12:34	
On	<input checked="" type="checkbox"/>	<input type="checkbox"/>	<input type="checkbox"/>	<input type="checkbox"/>	<input type="checkbox"/>	<input type="checkbox"/>	<input type="checkbox"/>	12:34	
Off	<input checked="" type="checkbox"/>	<input type="checkbox"/>	<input type="checkbox"/>	<input type="checkbox"/>	<input type="checkbox"/>	<input type="checkbox"/>	<input type="checkbox"/>	12:34	

Notes

Clock adjust

Use this menu to set date (in **dd:MM:yyyy** format), time (in **HH:mm** format) and time zone.

The date and time set here will affect any schedule created within the **Power On/Off** menu.

Clock Adjust	
Date (dd:MM:yyyy)	30:11:2017
Time (HH:mm)	16:00
Time Zone	UTC 00

PIC mute setting

PIC mute allows the projected image to be hidden without turning the projector off.

- PIC Mute**
 Choose from **Laser** and **DMD Blanking**. Select PIC Mute to turn the laser off when the PIC Mute activated. Select DMD Blanking to project a black image when PIC Mute is activated.
- Fade In Timer**
 Fade out timer is available when PIC Mute is set to Laser. Choose from **Off, 1s, 2s, 3s, 4s, and 5s**. Select Off to start projecting the image as soon as PIC Mute is deactivated. Select a time to fade the image in when PIC Mute is deactivated.
- Fade Out Timer**
 Fade in timer is available when PIC Mute is set to Laser. Choose from **Off, 1s, 2s, 3s, 4s, and 5s**. Select Off to stop projecting the image as soon as PIC Mute is activated. Select a time to fade the image out when PIC Mute is activated.

PIC Mute Setting	
PIC Mute	Laser
Fade In Timer	Off
Fade Out Timer	Off

Notes

OSD settings

- **Language** sets the OSD language.
- **Menu Position** determines where the OSD should appear on the screen when activated.
- **Menu Transparency** sets OSD transparency between 0% (no transparency), 25%, 50% and 75%.
- **Time Out** determines how long the OSD should remain on screen if no buttons are pressed. Choose Always On to disable this feature.
- **Message Box** determines whether projector status messages should appear on the screen.
- **Menu Rotation** Choose from **Off**, **Clockwise** and **Anticlockwise**. Select a rotation option to rotate the OSD menu when the projector is displaying in portrait.

OSD Settings	
Language	English
Menu Position	Center
Menu Transparency	0
Time Out	30 Seconds
Message Box	On
Menu Rotation	Off

Memory

The current image settings can be saved as a preset, which you can recall later. The default settings can be recalled at any time as well.

Up to four custom presets can be stored for each input.

To recall a saved preset:

- Select **Recall Memory** and press **ENTER/OK**, then select a preset from **Preset A** to **Preset D**. Select **Default** to load factory default values.

To save a preset:

- Select **Save Settings** and press **ENTER/OK**, then choose from **Preset A**, **Preset B**, **Preset C** and **Preset D**.

Memory	
Recall Memory	Default
Save Settings	Preset A

Notes

 Presets from one input cannot be applied to another input.

 Presets for inputs HDMI 3 and 4 do not contain all the settings normally stored for other inputs.

 See memory scheme and memory items on page 130 for information about the parameters that can be saved in a memory preset.

EDID Mode

Each signal input type is available in the menu. Select the appropriate frame rate and display resolution for each input.

EDID Mode	
HDMI 1	4K/60 HDR
HDMI 2	4K/60 HDR
HDMI 3	1920x1200xp60
HDMI 4	1920x1200xp60
DisplayPort	4K/60
HDBaseT	4K/60

Hotkey setting

- **Hotkey1Function**

Choose from **Information, Test Pattern, Lens Memory Load, Ambient Brightness Correction, FREEZE** and **PIP SWAP**. Select the function that you want to assign to hotkey1. This function will be activated when you press hotkey 1 on the control panel.

- **Hotkey2Function**

Choose from **Information, Test Pattern, Lens Memory Load, Ambient Brightness Correction, FREEZE** and **PIP SWAP**. Select the function that you want to assign to hotkey2. This function will be activated when you press hotkey 2 on the control panel.

- **Hotkey3Function**

Choose from **Information, Test Pattern, Lens Memory Load, Ambient Brightness Correction, FREEZE** and **PIP SWAP**. Select the function that you want to assign to hotkey3. This function will be activated when you press hotkey 3 on the control panel.

Hotkey Setting	
Hotkey1Function	Information
Hotkey2Function	Test Pattern
Hotkey3Function	Lens Memory Load

Notes



HOTKEY 3 is used when a lens adapter is installed. Whilst in standby mode, press and hold HOTKEY 3 for five seconds to run center lens before installing the lens.

Network menu

- **Network Setup**
Access this submenu to edit the network settings for the projector
- **Art-Net Setup**
Access this submenu to edit the Art-Net network settings for the projector
- **Art-Net Channel Setting**
Access this submenu to set the functions for each Art-Net channel
- **Art-Net Channel Status**
Access this submenu to view the status of each Art-Net channel
- **AMX** Switch on or off

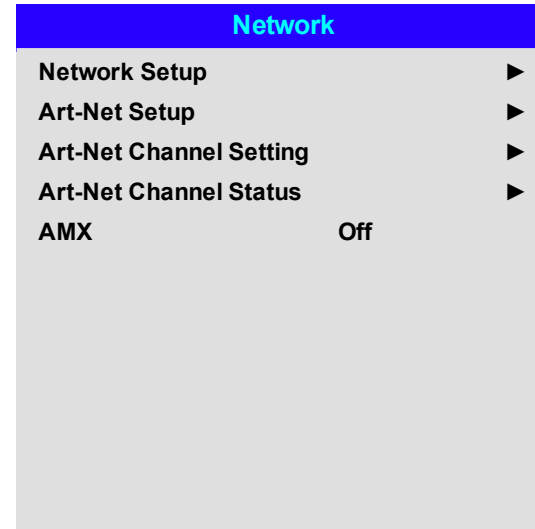

Notes

Network setup

- **DHCP, IP, Subnet Mask, Gateway, DNS**
Set **DHCP** to **On** if the IP address is to be assigned by a DHCP server, or **Off** if it is to be set here.
If **DHCP** is **On**, it will not be possible to edit **IP Address, Subnet Mask, Gateway** or **DNS**.
If **DHCP** is set to **Off**, edit **IP Address, Subnet Mask, Gateway** and **DNS** as required.
- **Apply**
Select to apply any changes to the network setup
- **MAC**
This field is read-only.

Network Setup	
DHCP	Off
IP	192 . 168 . 000 . 10
Subnet Mask	255 . 255 . 255 . 000
Gateway	000 . 000 . 000 . 000
DNS	000 . 000 . 000 . 000
Apply	
MAC	00: 18: 28: 2d: f2: 06

Art-net setup

- **Art-Net Active**
Set to **On** to activate art-net DMX electronic light system control via the art-net port.
Set the **Net, Sub Net, Universe** and **Start Address** for the network.
- **Apply**
Select to apply any changes to the art-net setup

Art-Net Setup	
Art-Net Active	Off
Net	-----
Sub Net	-----
Universe	-----
Start Address	-----
Apply	

Notes

Art-net channel setting

- **Chanel 1-5**

Choose from **None**, **Power**, **PIC Mute**, **Power Level**, **Input** and **Channel Control**. Select the projector functions that are associated with each art-net channel.

Art-Net Channel Setting	
Channel 1	Power
Channel 2	PIC Mute
Channel 3	Power Level
Channel 4	Input
Channel 5	Channel Control

Notes

PIP menu

- **PIP** Turn PIP on and off.
- **Source** Select an input source for the PIP image. Any combinations are possible between main and PIP input source, as long as one of the inputs is either **DisplayPort** or **3G-SDI**.
- **Position** Set the location of the PIP image on the screen. Choose from **Top-Left**, **Top-Right**, **Bottom-Left**, **Bottom-Right** and **PBP**.

PIP	
PIP	Off
Source	HDMI1
Position	Top-Left

Notes

 **PIP** functionality is not available with inputs HDMI 3 and HDMI 4

Information menu

This menu gives information about software and hardware configuration, input source and laser operating times. It also allows you to restore the factory default settings.

Information	
Model Name	Titan Laser 33000 4K-UHD
Serial Number	X000XXXXX0000
Software Version 1	MD03-SE10-FE09
Software Version 2	STEP_D08-24-17-3120
Software Version 3	2.0.16.0-P503
Active / PIP Source	HDMI 1
Signal Format	▶
Laser Hours	2
System Status	▶
Thermal Status	▶
Factory Reset	

Signal format

Signal Format	
Active Source	HDMI 1
Timing	3580x2160@59.9Hz
Scanning Frequency	H: 134.8 KHz V:59.9 Hz
Pixel Clock	593.80 MHz
Color Format	YCbCr 4:2:0 8 bit
HDR Format	No Data
PIP Source	NA
Timing	No Source
Scanning Frequency	H: NA V: NA
Pixel Clock	NA
Color Format	NA

Notes

 **PIP Source** items are not available with input HDMI 3 or HDMI 4.

System status

System Status	
Atmospheric Pressure	98988 Pa (116m)
AC Voltage	180V - 264V
Altitude Mode	Auto
Laser Power	100%
License Key	License Pass, Timeout, Not Expired
Constant Brightness	Off

Notes

Thermal status

Thermal Status	
Inlet/DMD Temp.	22 / 30 (C)
LD 1-5 Temp.	20/18/19/20/19 (C)
LD 6-10 Temp.	24/23/22/22/20 (C)
Fan 1-4 Speed	1406/1402/1396/1410
Fan 5-8 Speed	1493/1503/1493/1503
Fan 9-12 Speed	1498/1496/3010/NA
Fan 13-16 Speed	1691/3517/5886/2808
Fan 17-20 Speed	2804/4453/4453/4463
Fan 20-24 Speed	4519/1406/1406/1400
Fan 24-28 Speed	1396/1408/1408/1402
Fan 29 Speed	1396
Water Pump Speed	3412/3388/3412

Factory reset

To restore the factory default settings:

1. Navigate to **Factory Reset** and press **ENTER/OK**.
2. When prompted, press **ENTER/OK** to confirm your choice, or press **EXIT** to cancel.

Information	
Model Name	Titan Laser 33000 4K-UHD
Serial Number	X000XXXXX0000
Software Version 1	MD03-SE10-FE09
Factory Reset	
Warning	
All user settings will be lost	
Press OK to confirm Press Exit to cancel	
Thermal Status	▶
Factory Reset	OK

Notes

 Factory reset does not reset the Network settings, or High Altitude mode

Served web pages

The served web pages allow you to control the projector remotely via LAN.

The default IP address is **192.168.0.100**.

Notes

The screenshot displays the Digital Projection web interface. At the top is the logo with a rainbow underline. On the left is a navigation menu with buttons for: Projector Status, Projector Control, Crestron RoomView, Network Setup, Alert Mail Setup, Date/Time Setup, Error Log, and DP OSD Function. Below the menu are three buttons: PicMute, OSD, and Freeze. The main content area is divided into two sections: 'Projector Information' and 'LAN Information'. The 'Projector Information' section contains a table with the following data:

Model	Titan Laser 33000 4K-UHD	
Serial Number	d	
Software Version 1	ME20a-VE20-2.0.5-20181107	
Software Version 2	LE08-29-20-NA	
Software Version 3	2.0.32.2-CT03-125	
Power Status	Power On	
Input	HDMI 1	
Laser Status	Power : On	Runtime : 25 H
Projection Mode	Auto Front	
High Altitude	Auto	
Inlet Temperature	24	°C
DMD Temperature	34	°C
LD Temperature	33.9 / 32.6 / 32.6 / 32.6 / 31.3 °C	
LD Temperature 2	36.6 / 36.6 / 36.6 / 36.6 / 35.2 °C	
Diagnostic Status	No Error	

The 'LAN Information' section contains a single entry:

MAC address	00:18:32:AB:CD:EF
-------------	-------------------

DIGITAL PROJECTION

Projector Status

Projector Control

Crestron RoomView

Network Setup

Alert Mail Setup

Date/Time Setup

Error Log

DP OSD Function

Hot Key
PicMute OSD
Freeze

State Control

Power
On Off

Input Selection
HDMI 1 HDMI 2 HDMI 3 HDMI 4
DisplayPort HDBaseT 3G-SDI

Lens Control

Zoom In Focus In Shift
Zoom OUT Focus OUT

Notes

Notes

The screenshot shows the Digital Projection OSD interface. At the top, there are navigation links for 'Tools', 'Info', and 'Contact IT Help'. The main header features the 'DIGITAL PROJECTION' logo. Below the logo is a 'Power' button. The central area is titled 'Source List' and contains a scrollable menu with options: DisplayPort, **HDMI 1** (highlighted), HDMI 2, HDBaseT, and 3G-SDI. To the right of the source list is a control panel with buttons for 'Menu', 'Auto', 'Enter', 'Blank', 'Source', and 'Exit'. At the bottom of the OSD, there are buttons for 'Freeze', 'Contrast', 'Brightness', and 'Sharpness'. The footer includes the 'CRESTRON connected' logo and 'Expansion Options'.

The screenshot shows the Digital Projection OSD interface for network configuration. The 'DIGITAL PROJECTION' logo is at the top. On the left, a sidebar lists menu items: Projector Status, Projector Control, Crestron RoomView, **Network Setup** (selected), Alert Mail Setup, Date/Time Setup, Error Log, and DP OSD Function. Below the sidebar are 'Hot Key' settings for PicMute, OSD, and Freeze. The main content area is titled 'NetWork' and contains the following settings:

- DHCP:** On Off
- IP Address:** 192 . 168 . 0 . 100
- Subnet Mask:** 255 . 255 . 255 . 0
- Gateway:** 192 . 168 . 0 . 254
- DNS Server:** 192 . 168 . 0 . 1
- AMX:** Off ON

A 'Save Settings' button is located below the DNS Server field. A **CAUTION:** message states: 'Incorrect settings may cause the projector to lose network connectivity. Please close webpage and reload when you settings.'

DIGITAL PROJECTION

- Projector Status
- Projector Control
- Crestron RoomView
- Network Setup
- Alert Mail Setup
- Date/Time Setup
- Error Log
- DP OSD Function

Hot Key
PicMute OSD
Freeze

Server Setup

SMTP Server: Port: 25
User Name:
Password:

Mail

E-mail Alert: Enable Disable
From:
To:
CC:
Projector Name: d
Location:

Test

Periodic Report

days Sun Mon Tue Wed Thu Fri Sat

Times

<input type="checkbox"/> 00:00	<input type="checkbox"/> 01:00	<input checked="" type="checkbox"/> 02:00	<input type="checkbox"/> 03:00
<input type="checkbox"/> 04:00	<input checked="" type="checkbox"/> 05:00	<input checked="" type="checkbox"/> 06:00	<input type="checkbox"/> 07:00
<input type="checkbox"/> 08:00	<input type="checkbox"/> 09:00	<input type="checkbox"/> 10:00	<input type="checkbox"/> 11:00
<input type="checkbox"/> 12:00	<input type="checkbox"/> 13:00	<input type="checkbox"/> 14:00	<input type="checkbox"/> 15:00
<input type="checkbox"/> 16:00	<input type="checkbox"/> 17:00	<input checked="" type="checkbox"/> 18:00	<input type="checkbox"/> 19:00
<input type="checkbox"/> 20:00	<input checked="" type="checkbox"/> 21:00	<input checked="" type="checkbox"/> 22:00	<input type="checkbox"/> 23:00

Notes

Notes

No	Code	PwrOn	L1(Hr/Pwr)	T(Ti/Tc)	Desc
1	3501	182	50/30	25/29	ErrLaserBankSensor1Fail
2	0821	176	48/0	25/32	ErrPw2SpinUp
3	1171	164	44/30	25/34	ErrRightCoverOpen
4	1141	144	24/100	24/24	ErrLensSwitchOpen
5	3501	116	18/30	26/28	ErrLaserBankSensor1Fail
6	3501	31	5/30	25/26	ErrLaserBankSensor1Fail

Page 1 Page 2 Page 3

- Projector Status
- Projector Control
- Creston RoomView
- Network Setup
- Alert Mail Setup
- Date/Time Setup
- Error Log
- DP OSD Function
 - Hot Key
 - PicMute
 - OSD
 - Freeze

Input

- Input: HDMI1

Test Pattern

Exit Test Pattern

Lens

- Lens Lock: off on
- Lens Type: 1.4-1.9:1
- Center Lens: Do
- Lens Memory: Memory 1
- Buttons: Save, Load, Clear

Image

- DynamicBlack: off on
- Light Off Timer: Disable
- Smooth Picture: Auto
- Gamma: 2.2
- HDR Mode: HDR Auto
- Brightness: 101
- Contrast: 100
- Staturation: 100
- Hue: 100
- Sharpness: 0
- Noise Reduction: off
- Freeze
- Resync
- Ambient Brightness Correction: Off

color

- ColorSpace: Auto
- ColorMode: ColorMax
- ColorMax: Peak
- Manual Color Matching
 - Red**
 - Hue: 250
 - Saturation: 250
 - Gain: 250
 - Green**
 - Hue: 250
 - Saturation: 250
 - Gain: 250
 - Blue**
 - Hue: 250
 - Saturation: 250
 - Gain: 250
 - Yellow**
 - Hue: 250
 - Saturation: 250
 - Gain: 250
 - Magenta**
 - Hue: 250
 - Saturation: 250
 - Gain: 250
 - Cyan**
 - Hue: 250
 - Saturation: 250
 - Gain: 250
 - White Balance**
 - Red: 250
 - Green: 250
 - Blue: 250
- Manual Color Matching Reset
- Color Temperature: 6500K
 - Gains and Lifts
 - Red Lift: 100
 - Green Lift: 100
 - Blue Lift: 100
 - Red Gain: 100
 - Green Gain: 100
 - Blue Gain: 100
- Gains and Lifts Reset

Page 1 Page 2 Page 3

Notes

Projector Status
 Projector Control
 Crestron RoomView
 Network Setup
 Alert Mail Setup
 Date/Time Setup
 Error Log
 DP OSD Function
 Hot Key PicMute OSD Freeze

Page 1 Page 2 Page 3

geometry

- Aspect Ratio Source
- Digital Zoom Digital Zoom + 0%
- Digital Pan Digital Pan + 0
- Digital Scan Digital Scan + 0
- Digital Zoom Reset
- OverScan Off
- Blanking Top Bottom Left Right
- Blanking Reset
- Keystone H Keystone V Keystone Rotation Lens Throw Ratio
- Keystone Reset
- 4 Corners Top Left Corner X Top Left Corner Y Top Right Corner X Top Right Corner Y Bottom Left Corner X Bottom Left Corner Y Bottom Right Corner X Bottom Right Corner Y
- 4 Corners Reset
- Rotation Rotation Reset
- Pincushion/Barrel H Pin/Barrel V Pin/Barrel Keystone H Keystone V Keystone Rotation Lens Throw Ratio
- Pincushion/Barrel Reset

Arc Top Bottom Left Right

Arc Reset

Custom Warp Off

edgeblend

- Edge Blend off on
- Align Pattern off on
- Blend Width Top Bottom Left Right
- Black Level Uplift Select Area Top Bottom Left Right
- Color Adjustment All Red Green Blue
- Edgeblend Reset

3d

- 3D Format Off
- Eye Swap Normal Reverse
- Dark Time 1.95ms
- 3D Sync Offset Reference External Internal

laser

- Power Mode Custom
- Power Level + 30
- Constant Brightness Off
- MUBC Mode Off
 - MUBC Group 0 1 2
 - MUBC Refresh Interval
 - MUBC Connection Status 0

Notes

DIGITAL PROJECTION

Page 1 Page 2 Page 3

Projector Status

Projector Control

Crestron RoomView

Network Setup

Alert Mail Setup

Date/Time Setup

Error Log

DP OSD Function

Hot Key
PicMute OSD
Freeze

setup

- Orientation Auto-front
- High Altitude Auto
- Standby Mode Normal
- Screen Setting 16:10
- ColorMax

Measured Data

Red	X:0.666	Y:0.327
Green	X:0.328	Y:0.641
Blue	X:0.140	Y:0.025
White	X:0.269	Y:0.294

Measured Data Save Measured Data Reset

Target Data - User 1

Red	X:0.640	Y:0.330
Green	X:0.300	Y:0.600
Blue	X:0.150	Y:0.060
Yellow	X:0.419	Y:0.505
Cyan	X:0.225	Y:0.329
Magenta	X:0.321	Y:0.154
White	X:0.285	Y:0.302

Target Data - User 1 Save Target Data - User 1 Reset

Target Data - User 2

Red	X:0.640	Y:0.330
Green	X:0.300	Y:0.600
Blue	X:0.150	Y:0.060
Yellow	X:0.419	Y:0.505
Cyan	X:0.225	Y:0.329
Magenta	X:0.321	Y:0.154
White	X:0.285	Y:0.302

Target Data - User 2 Save Target Data - User 2 Reset

- Power On/Off
 - Auto Power Off off on
 - Auto Power On off on
 - Scheduled on/off off on

	Sun	Mon	Tue	Wed	Thu	Fri	Sat	Time(HH:MM)
On	<input checked="" type="checkbox"/>	<input type="checkbox"/>	<input type="checkbox"/>	<input type="checkbox"/>	<input type="checkbox"/>	<input type="checkbox"/>	<input type="checkbox"/>	00:00
Off	<input type="checkbox"/>	<input type="checkbox"/>	<input type="checkbox"/>	<input type="checkbox"/>	<input type="checkbox"/>	<input type="checkbox"/>	<input type="checkbox"/>	00:00
On	<input type="checkbox"/>	<input type="checkbox"/>	<input type="checkbox"/>	<input type="checkbox"/>	<input type="checkbox"/>	<input type="checkbox"/>	<input type="checkbox"/>	00:00
Off	<input type="checkbox"/>	<input type="checkbox"/>	<input type="checkbox"/>	<input type="checkbox"/>	<input type="checkbox"/>	<input type="checkbox"/>	<input type="checkbox"/>	00:00

- Startup Logo Off Original User
- Blank Screen Logo
- Auto Source off on
- Shutter Setting
 - PIC MUTE DMD Blanking Laser
 - Fade In Timer 1s
 - Fade Out Timer 5s
- Trigger-1 Off
- Trigger-2 Off
- Infrared Remote off on
- IR Code 0 Sent IR Code IR Code Reset
- OSD Setting
 - Language English
 - Menu Position Center
 - Menu Transparency 0
 - Time Out Always On
 - Message Box off on
 - Menu Rotation Off
- Memory
 - Recall Memory Default
 - Save Settings Preset A
- Instant Startup off on
- Standby Period 30 Min.
- EDID Mode
 - HDMI1 4K/60 HDR
 - HDMI2 4K/60 HDR
 - HDMI3 1920x1200@60
 - HDMI4 1920x1200@60
 - DisplayPort 4K/60
 - HDBaseT 4K/30
- Hotkey Setting
 - Hotkey1 Function Information
 - Hotkey2 Function Test Pattern
 - Hotkey3 Function Lens Memory Load
- Keypad Button Backlight off on
- Smear Reduction Off
- Output Frame Rate 60Hz

Notes

Notes

pip

- PIP off on
- Source HDMI2
- Position Top-Left

information

- Model Name Titan Laser 33000 4K-UHD
- Serial Number d
- Software Version 1 ME20a-VE20-2.0.5-20181107
- Software Version 2 LE08-29-20-NA
- Software Version 3 2.0.32.2-CT03-125
- Active/PIP Source HDMI1/NA
- Signal Format
 - Active Source HDMI1
 - Timing 1920x1080@59.9 Hz
 - Scanning Frequency h: 67.4 kHz v: 59.9 Hz
 - Pixel Clock 148.40 MHz
 - Color Format YCbCr 4:4:4 8 bit
 - HDR Format No Data
- PIP Source NA
- Timing No Source
- Scanning Frequency h: NA v: NA
- Pixel Clock NA
- Color Format NA NA
- Laser Hours 25
- System Status
 - Atmospheric Pressure 101114 Pa(17 m)
 - AC Voltage 180V-264V
 - Altitude Mode Auto
 - Laser Power 30
 - License Key License Pass, Timeout Not Expired
 - Constant Brightness OFF
- Thermal Status
 - Inlet /DMD Temp. 24 /33
 - LD 1-5 Temp. 33.9 / 32.6 / 32.6 / 31.3 / 31.3
 - LD 6-10 Temp. 36.6 / 36.6 / 36.6 / 35.2 / 33.9
 - Fan 1-4 Speed 1006/967/1038/1002
 - Fan 5-8 Speed 999/978/1002/1001
 - Fan 9-12 Speed 1000/1024/3024/NA
 - Fan 13-16 Speed 1715/3001/5028/2824
 - Fan 17-20 Speed 2796/4499/4509/4504
 - Fan 21-24 Speed 4504/1005/1059/994
 - Fan 25-28 Speed 973/992/987/1396
 - Fan 29 Speed 1398
 - Water Pump Speed 3412/3418/3382
- Factory Reset

DIGITAL **PROJECTION**

A Delta Associate Company

***Titan Laser* WUXGA**

High Brightness Digital Video Projector

REFERENCE GUIDE



Choosing a lens

A number of lenses are available. Which lens you choose depends on the screen size, image aspect ratio, throw distance and light output.

The following table shows all available lenses in order of their throw ratios:

Lens	Focus Range	Lens Shift	Lens Extension	Part No
0.67 : 1 Super Wide fixed	1.1 m - 10 m	V: 0.1 (U) 0.1 (D) frame H: 0.04 (L) 0.04 (R) frame	141mm	105-607
1.12 : 1 Wide Fixed	3 m - 15 m	V: 0.567 (U) 0.45 (D) frame H: 0.188 (L) 0.188 (R) frame	205mm	105-608
1.16-1.49:1 Super Wide Zoom	3 m - 15 m	V: 0.4 (U) 0.4 (D) frame H: 0.188 (L) 0.188 (R) frame	162.5mm	109-236
1.39 - 1.87:1 Wide Zoom	4 m - 24 m	V: 0.567 (U) 0.45 (D) frame H: 0.188 (L) 0.188 (R) frame	130.5mm	105-610
1.87 - 2.56:1 Standard Zoom	4 m - 24 m	V: 0.567 (U) 0.45 (D) frame H: 0.188 (L) 0.188 (R) frame	95.3 mm	105-611
2.56 - 4.16:1 Semi Long Zoom	9.1 m - 45 m	V: 0.567 (U) 0.45 (D) frame H: 0.188 (L) 0.188 (R) frame	88.7mm	105-612
4.16 - 6.96:1 Long Zoom1	12 m - 80 m	V: 0.567 (U) 0.45 (D) frame H: 0.188 (L) 0.188 (R) frame	55mm	105-613
6.92 - 10.36:1 Long Zoom2	12 m - 80 m	Vt: 0.567 (U) 0.45 (D) frame H: 0.188 (L) 0.188 (R) frame	105mm	109-235

To choose a lens, calculate the **throw ratio** required. Allow a tolerance of +/- 3% in the throw ratio calculation.

Notes



See *Fitting a lens hood* on page 27 for more information about using the right lens and hood

Basic calculation

Identify the required lens by calculating the **throw ratio**.

A **throw ratio** is the ratio of the throw distance **2** to the screen width **1**:

$$\text{ThrowRatio} = \text{ThrowDistance} / \text{ScreenWidth}$$

1. Use the formula above to obtain the required throw ratio.
2. Allow a tolerance of +/- 3% in the throw ratio calculation and match the throw ratio with a lens from the table below:

Throw ratios	Focus Range
0.67 : 1 Super Wide fixed	1.1m - 10m
1.12 : 1 Wide Fixed	3m - 15m
1.16-1.49:1 Super Wide Zoom	3m - 15m
1.39 - 1.87:1 Wide Zoom	4m - 24m
1.87 - 2.56:1 Standard Zoom	4m - 24m
2.56 - 4.16:1 Semi Long Zoom	9.1m - 45m
4.16 - 6.96:1 Long Zoom1	12m - 80m
6.92 - 10.36:1 Long Zoom2	12m - 80m

3. Ensure the required throw distance is within the range covered by the lens.

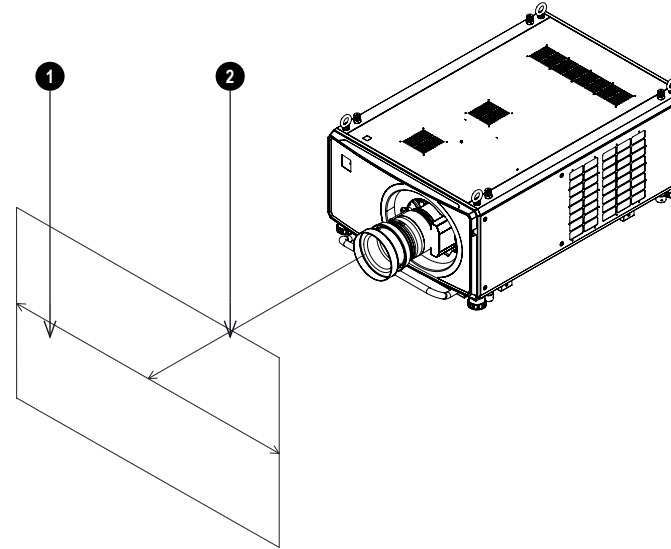

Notes

The basic calculation on this page does not take into consideration DMD™ and image size, which could affect the throw ratio. See Full lens calculation on page 111 for a more complex and realistic calculation.

When calculating the throw ratio, be sure to use identical measurement units for both the throw distance and the screen width.

See Choosing a lens on the previous page for information about individual lens part numbers

See Fitting a lens hood on page 27 for more information about using the right lens and hood

Basic calculation example

1. Calculate the throw ratio using the formula.
Your screen is **4.5m** wide and you wish to place the projector approximately **11m** from the screen. The throw ratio will then be
 $11 \div 4.5 = \mathbf{2.44}$
2. Match the result with the lens table.
The lens matching a throw ratio of 2.44 is the **1.87 - 2.56:1 Standard Zoom lens**.
3. **Check whether the lens covers the required throw distance.**
The focus range quoted for the 1.87 - 2.56:1 Standard Zoom lens is **4 - 24m**. The required distance of 11m is within the range.

INFORMATION YOU NEED FOR THIS CALCULATION

The throw ratio formula:

$$\mathbf{ThrowRatio = ThrowDistance / ScreenWidth}$$

Allow a tolerance of +/- 3% in the throw ratio calculation.

The lens table:

Throw ratios	Focus Range
0.67 : 1 Super Wide fixed	1.1m - 10m
1.12 : 1 Wide Fixed	3m - 15m
1.16-1.49:1 Super Wide Zoom	3m - 15m
1.39 - 1.87:1 Wide Zoom	4m - 24m
1.87 - 2.56:1 Standard Zoom	4m - 24m
2.56 - 4.16:1 Semi Long Zoom	9.1m - 45m
4.16 - 6.96:1 Long Zoom1	12m - 80m
6.92 - 10.36:1 Long Zoom2	12m - 80m

Notes

 The basic calculation on this page does not take into consideration DMD™ and image size, which could affect the throw ratio. See Full lens calculation on the facing page for a more complex and realistic calculation.

 See Choosing a lens on page 108 for information about individual lens part numbers.

Full lens calculation

Introducing TRC

The choice of lens will affect the image size and will address discrepancies between the DMD™ resolution and the source.

When an image fills the height of the DMD™ but not the width, it uses less than 100% of the DMD™ surface. A lens chosen using the basic formula may produce an image that is considerably smaller than the actual screen.

To compensate for loss of screen space in such situations, you need to increase the throw ratio using a **Throw Ratio Correction (TRC)**.

Example

Fig. 1 illustrates a 4:3 image within a 16:9 display

When a 16:9 projector is used for a 4:3 image, the image does not fill the width of the DMD™, creating a **pillarboxing** effect - blank spaces to the left and right.

Fig. 2 shows the same image projected on a 4:3 screen using a standard lens (chosen with the basic calculation).

The DMD™ accurately fills the width of the screen; however, the pillarboxing is now part of the projected image and is transferred to the screen.

The DMD™ does not fill the height of the screen, which has caused **letterboxing** - further blank spaces at the top and bottom of the screen.

The image is now surrounded by blank space, which can be removed if the throw ratio is increased.

Fig. 3 shows the image projected on the same screen with a lens chosen using TRC. The increased throw ratio has allowed the 4:3 image to fill the 4:3 screen seamlessly



Fig 1

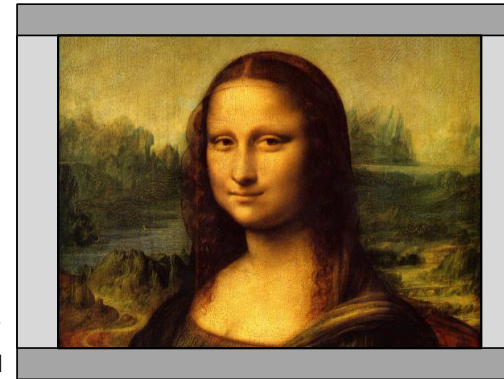

Fig 2



Fig 3

Notes



TRC can only be applied if greater than 1. If TRC is 1 or less, disregard it and calculate the throw ratio using the basic formula.

Calculating TRC

To calculate TRC, use the following formula:

$$TRC = 1.6(DMD^{\text{TM}} \text{ AspectRatio}) / \text{Source AspectRatio}.$$

TRC table

Alternatively, you can save time by referencing the following table, which shows the TRC value for some popular image formats:

2.35:1 (Scope)	1920 x 817 pixels	TRC < 1, not used
1.85:1 (Flat)	1920 x 1037 pixels	TRC < 1, not used
1.78:1 (16:9)	1920 x 1080 pixels	TRC < 1, not used
1.6:1 (16:10)	1920 x 1200 pixels	TRC < 1, not used (native aspect ratio)
1.33:1 (4:3)	1596 x 1200 pixels	TRC = 1.2
1.25:1 (5:4)	1500 x 1200 pixels	TRC = 1.28

Calculating the throw ratio with TRC

- For TRC > 1, amend the basic throw ratio formula as follows:

$$\text{ThrowRatio} = \text{ThrowDistance} / \text{ScreenWidth} * TRC$$

Allow a tolerance of +/- 3% in the throw ratio calculation.

- Once a throw ratio is established, identify the matching lens from the table:

Throw ratios	Focus Range
0.67 : 1 Super Wide fixed	1.1m - 10m
1.12 : 1 Wide Fixed	3m - 15m
1.16-1.49:1 Super Wide Zoom	3m - 15m
1.39 - 1.87:1 Wide Zoom	4m - 24m
1.87 - 2.56:1 Standard Zoom	4m - 24m
2.56 - 4.16:1 Semi Long Zoom	9.1m - 45m
4.16 - 6.96:1 Long Zoom1	12m - 80m
6.92 - 10.36:1 Long Zoom2	12m - 80m

- Ensure the required throw distance is within the range of the matching lens.

Notes

 TRC can only be applied if greater than 1. If TRC is 1 or less, disregard it and calculate the throw ratio using the basic formula.

 TRC can only be applied if greater than 1. If TRC is 1 or less, disregard it and calculate the throw ratio using the basic formula

 See Fitting a lens hood on page 27 for more information about using the right lens and hood

Full lens calculation example

Your screen is **4.5m** wide; you wish to place the projector approximately **11m** from the screen. The source is **4:3**.

1. Calculate TRC as follows:
TRC = 1.6 / 1.33 = 1.2.
2. Calculate the throw ratio:
Throw ratio = 11 / 4.5 x 1.2 = **2.04**
3. Allow a tolerance of +/- 3% in the throw ratio calculation and find a match in the lens table.
The table shows that the matching lens is **the 1.87 - 2.56:1 Standard Zoom lens**.
4. Check whether the lens covers the required throw distance.
The focus range quoted for the 1.87 - 2.56:1 Standard Zoom lens is **4m - 24m**. The required distance of 11 m is within the range.

INFORMATION YOU NEED FOR THESE CALCULATIONS

The TRC formula

TRC = DMD™ AspectRatio/SourceAspectRatio

The TRC table (to use instead of the formula)

2.35:1 (Scope) TRC < 1, not used
1.85:1 (Flat) TRC < 1, not used
1.78:1 (16:9) TRC < 1, not used
1.6:1 (16:10) TRC < 1, not used (native aspect ratio)
1.33:1 (4:3) TRC = 1.2
1.25:1 (5:4) TRC = 1.28

The throw ratio formula

ThrowRatio = ThrowDistance/ScreenWidth * TRC

Allow a tolerance of +/- 3% in the throw ratio calculation.

The lens table:

Throw ratios	Focus Range
0.67 : 1 Super Wide fixed	1.1m - 10m
1.12 : 1 Wide Fixed	3m - 15m
1.16-1.49:1 Super Wide Zoom	3m - 15m
1.39 - 1.87:1 Wide Zoom	4m - 24m
1.87 - 2.56:1 Standard Zoom	4m - 24m
2.56 - 4.16:1 Semi Long Zoom	9.1m - 45m
4.16 - 6.96:1 Long Zoom1	12m - 80m
6.92 - 10.36:1 Long Zoom2	12m - 80m

Notes

Screen requirements

Fitting the image to the display

If the source image supplied to the projector is smaller than the WUXGA resolution, the image will not fill the display. The following examples show how a number of common formats may be displayed, depending on your DMD™ resolution.

WUXGA images displayed full width

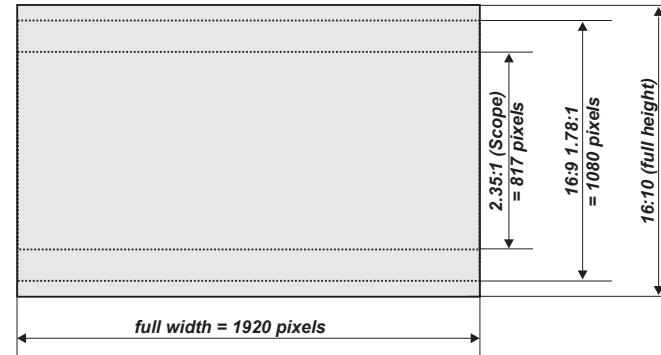

WUXGA images displayed with a height of 1200 pixels

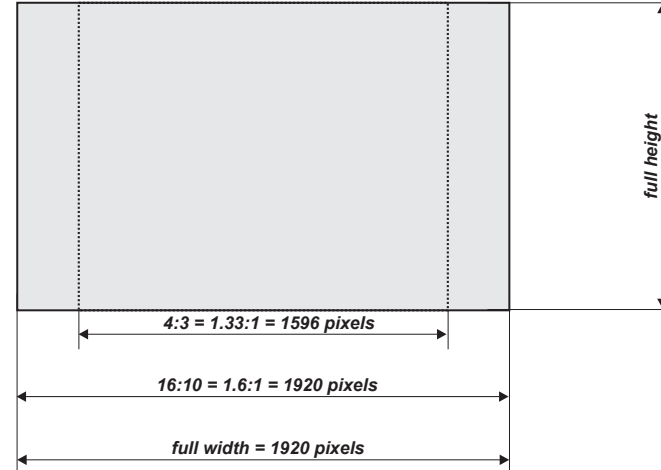

Notes

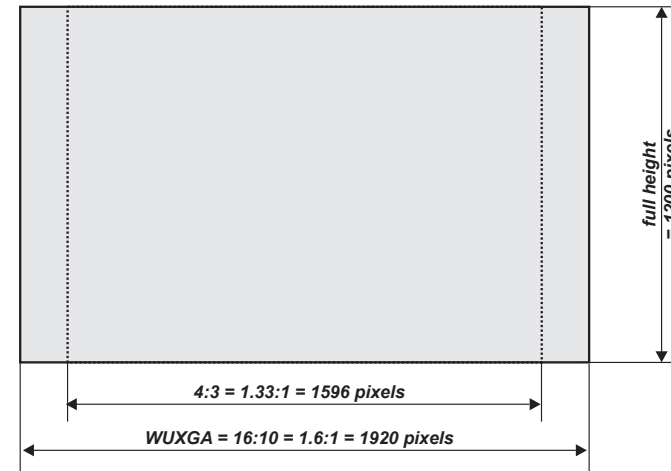
WUXGA images displayed full height**Diagonal screen sizes**

Screen sizes are sometimes specified by their diagonal size (D). When dealing with large screens and projection distances at different aspect ratios, it is more convenient to measure screen width (W) and height (H).

The example calculations below show how to convert diagonal sizes into width and height, at various aspect ratios.

2.35:1 (Scope)

$$W = D \times 0.92 \quad H = D \times 0.39$$

1.85:1

$$W = D \times 0.88 \quad H = D \times 0.47$$

16:9 = 1.78:1

$$W = D \times 0.87 \quad H = D \times 0.49$$

16:10 = 1.6:1 (native aspect ratio for WUXGA projectors)

$$W = D \times 0.85 \quad H = D \times 0.53$$

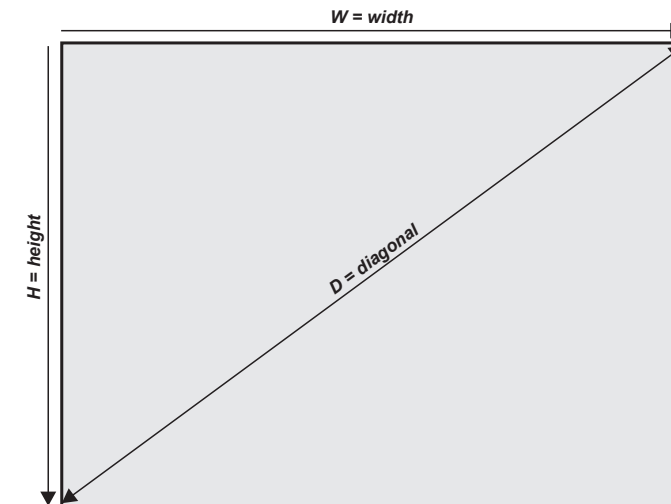
**Notes**

Positioning the image

The normal position for the projector is at the centre of the screen. However, you can set the projector above or below the centre, or to one side, and adjust the image using the **Lens shift** feature (known as **rising and falling front**) to maintain a geometrically correct image.

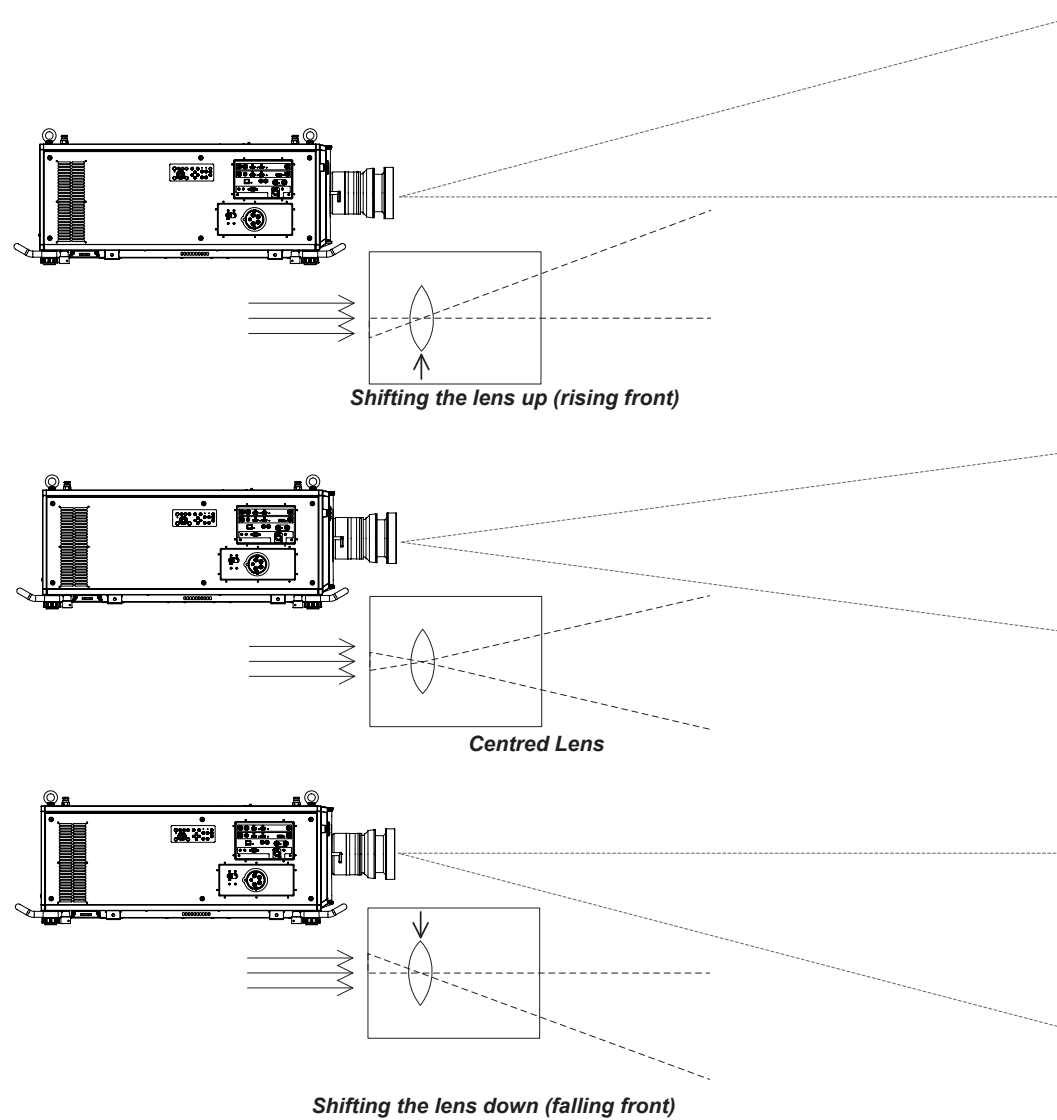

Notes

 See *Lens control* on page 50 for more information on shifting the lens.

 Whenever possible, position the projector so that the lens is centered for the highest quality image

Any single adjustment outside the ranges specified on the following page may result in an unacceptable level of distortion, particularly at the corners of the image, due to the image passing through the periphery of the lens optics.

If the lens is to be shifted in two directions combined, the maximum range without distortion will be somewhat less, as can be seen in the illustrations.

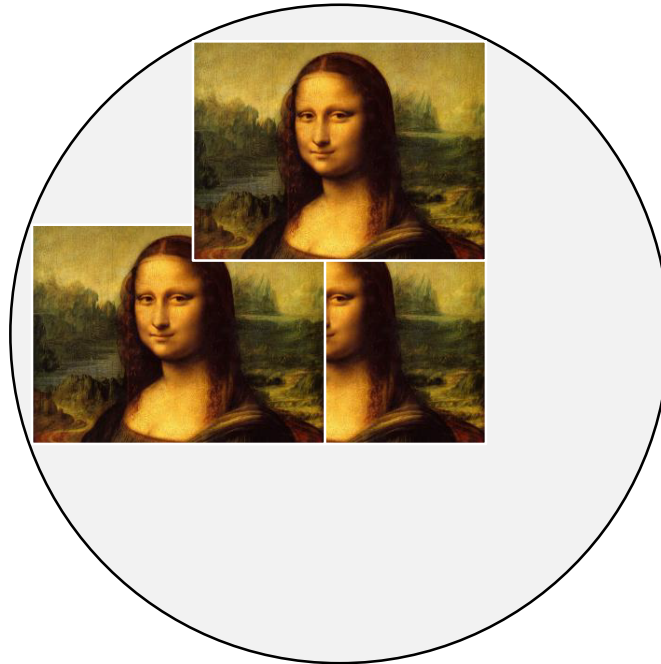

Full horizontal or vertical shift

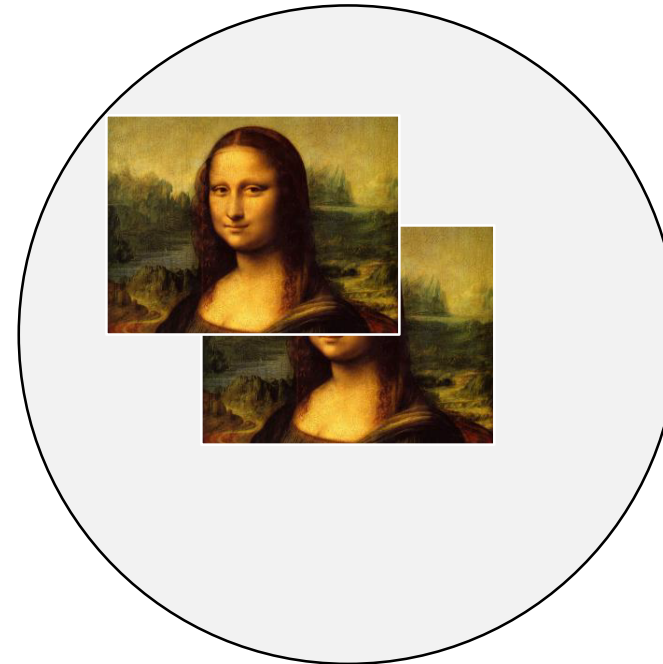

Combined shift is reduced

Notes

See *Lens control* on page 50 for more information on shifting the lens.

Aspect ratios explained

The appearance of a projected image on the screen depends on a combination of the following:

- The display resolution is **WUXGA** with a 1920 x 1200 resolution, corresponding to an aspect ratio of 16:10
- The aspect ratio of the input signal: usually **4:3**, **16:9** or **16:10**
- The value of the **Aspect Ratio** setting of the projector:
 - **16:9**, **4:3**, **16:10** and **5:4** stretch the image to the selected aspect ratio. **16:9** leaves black bars at the top and bottom of the screen (letterboxing effect); **4:3** and **5:4** leave black bars at the sides of the screen (pillarboxing).
 - **TheaterScope** is a special setting used in combination with an anamorphic lens, an optional accessory. It removes letterboxing from a 2.35:1 source packed into a 16:9 frame.
 - **Source** shows the image with its original aspect ratio, if this does not match the native aspect ratio of the DMD™, then the image will be scaled to either fit the full width or height of the display.

Aspect ratios examples

1. Unused screen areas

Source: 4:3

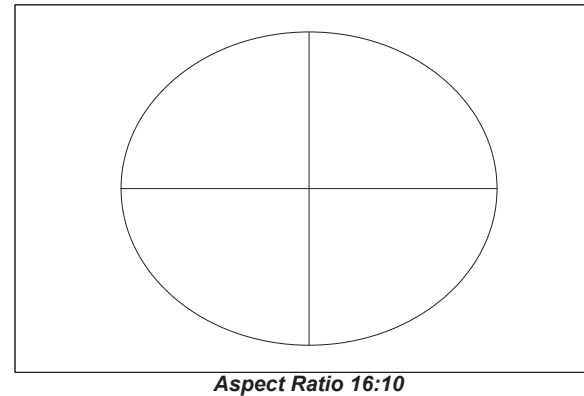
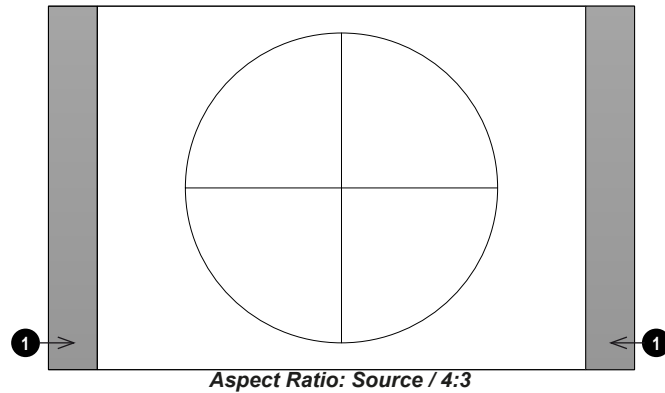

Notes

Source: 16:9

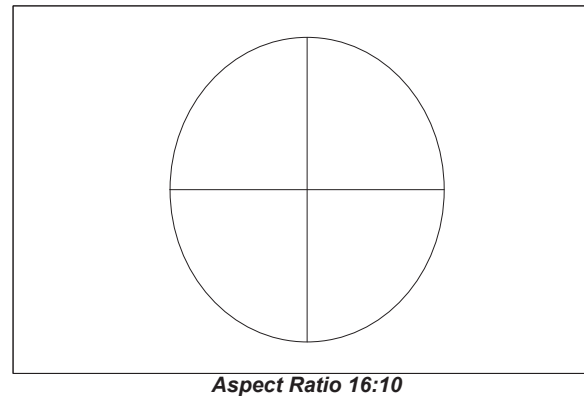
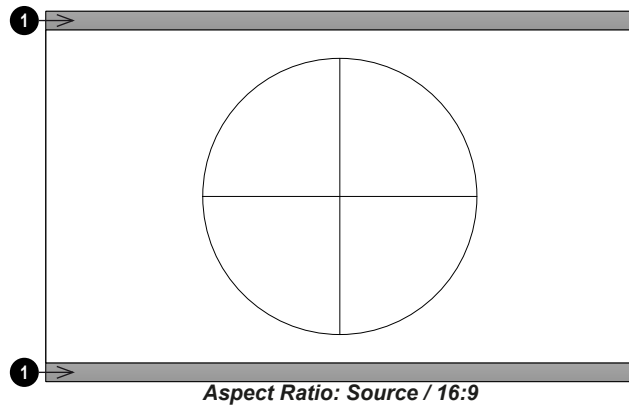

Source: 16:10 (native)

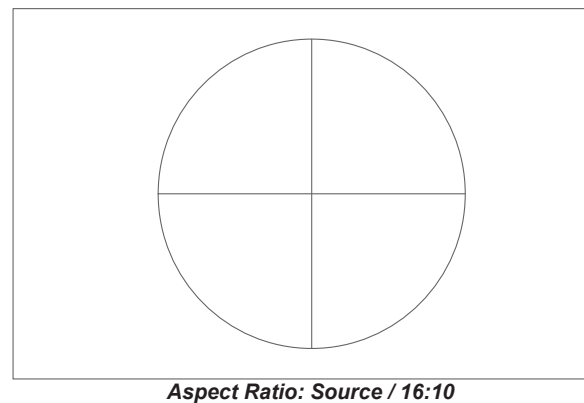

Notes

Aspect ratio example: TheatreScope

The TheaterScope setting is used in combination with an anamorphic lens to restore 2.35:1 images packed into a 16:9 frame. Such images are projected with black lines at the top and bottom of the 16:9 screen to make up for the difference in aspect ratios.

Without an anamorphic lens and without the TheaterScope setting applied, a 16:9 source containing a 2.35:1 image looks like this:

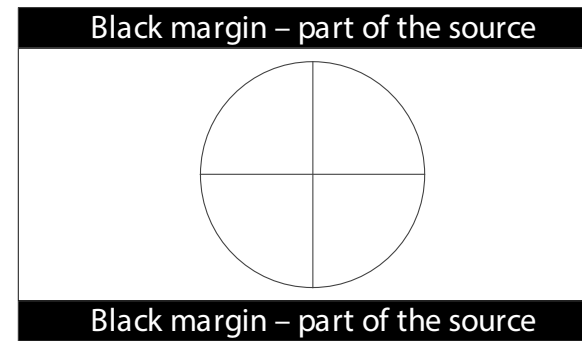

If we change the setting to TheaterScope, the black lines will disappear but the image will stretch vertically to reach the top and bottom of the DMD™:

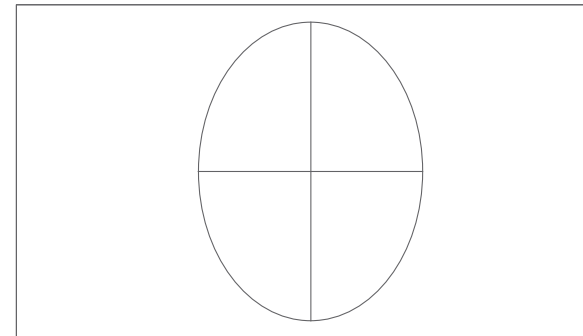

An anamorphic lens will stretch the image horizontally, restoring the original 2.35 ratio:

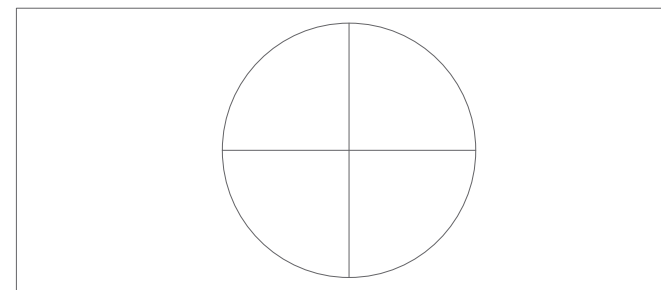

Notes

Appendix A: supported signal input modes

2D formats

Signal Format	Resolution	Frame Rate (Hz)	Display Port	HDMI 1/2 & HDBaseT			HDMI3/4		Output Frame Rate (Hz)	Remarks
				RGB	YUV 8-bit	YUV 10-bit	YUV 12-bit	RGB		
PC	640 x 480	60	✓	✓					60	
	640 x 480	75	✓	✓					60	
	640 x 480	85	✓	✓					60	
	800 x 600	60	✓	✓					60	
	800 x 600	75	✓	✓					60	
	800 x 600	85	✓	✓					60	
	848 x 480	48	✓	✓					48	
	848 x 480	60	✓	✓					60	
	1024 x 768	60	✓	✓					60	
	1024 x 768	75	✓	✓					60	
	1024 x 768	85	✓	✓					60	
	1280 x 720	48	✓	✓					48	
	1280 x 768	60	✓	✓					60	
	1280 x 800	60	✓	✓					60	
	1280 x 960	60	✓	✓					60	
	1280 x 1024	60	✓	✓					60	
	1280 x 1024	75	✓	✓					60	
	1280 x 1024	85	✓	✓					60	
	1366 x 768	60	✓	✓					60	
	1440 x 900	60	✓	✓					60	
	1400 x 1050	60	✓	✓					60	
	1600 x 1200	60	✓	✓					60	
	1680 x 1050	60	✓	✓					60	
	1920 x 1080	48	✓	✓					48	
	1920 x 1200 RB	50	✓	✓				✓	50	
	1920 x 1200 RB	60	✓	✓				✓	60	

Notes

Signal Format	Resolution	Frame Rate (Hz)	Display Port	HDMI 1/2 & HDBaseT			HDMI3/4		Output Frame Rate (Hz)	Remarks	Notes
				RGB	YUV 8-bit	YUV 10-bit	YUV 12-bit	RGB			
	1920 x 1080	100	✓	X *4					50 at 4K display 100 at WUXGA display	*4 HDMI 1,2 support but HDBaseT does not support	
	1920 x 1080	120	✓	X *4					60 at 4K display 120 at WUXGA display		
	1920 x 1200	100	✓	X *4					50 at 4K display 100 at WUXGA display		
	1920 x 1200 RB	120	✓	X *4					60 at 4K display 120 at WUXGA display		
Apple Mac	640 x 480	67	✓	✓					60		
	832 x 624	75	✓	✓					60		
SDTV	480i	59.94							60		
	1440x480i	60.00		✓	✓	✓	✓		60		
	1440x576i	50.00		✓	✓	✓	✓		50		
	576i	50.00							50		
EDTV	480p	59.94	✓	✓	✓	✓	✓	✓	✓	60	
	576p	50.00	✓	✓	✓	✓	✓	✓	✓	50	
HDTV	1035i	60.00	✓	✓	✓	✓	✓			60	
	1080i	50.00	✓	✓	✓	✓	✓			50	
	1080i	59.94	✓	✓	✓	✓	✓			60	
	1080i	60.00	✓	✓	✓	✓	✓			60	
	720p	50.00	✓	✓	✓	✓	✓	✓	✓	60	
	720p	59.94	✓	✓	✓	✓	✓	✓	✓	60	
	720p	60.00	✓	✓	✓	✓	✓	✓	✓	60	
	1080p	23.98	✓	✓	✓	✓	✓			48	
	1080p	24.00	✓	✓	✓	✓	✓			48	
	1080p	25.00	✓	✓	✓	✓	✓			60	
	1080p	29.97	✓	✓	✓	✓	✓			60	
	1080p	30.00	✓	✓	✓	✓	✓			60	
	1080p	50.00	✓	✓	✓	✓	✓	✓	✓	50	
	1080p	59.94	✓	✓	✓	✓	✓	✓	✓	60	
1080p	60.00	✓	✓	✓	✓	✓	✓	✓	60		
	2K (2048x1080)	24	✓	✓	✓	✓	✓			48	
	2K (2048x1080)	25	✓	✓	✓	✓	✓			50	

Signal Format	Resolution	Frame Rate (Hz)	Display Port	HDMI 1/2 & HDBaseT			HDMI3/4		Output Frame Rate (Hz)	Remarks	Notes
				RGB	YUV 8-bit	YUV 10-bit	YUV 12-bit	RGB			
	2K (2048x1080)	30	✓	✓	✓	✓	✓		60		
	2K (2048x1080)	50	✓	✓	✓	✓	✓		50		
	2K (2048x1080)	60	✓	✓	✓	✓	✓		60		
	4K-UHD (3840x2160)	24	✓	✓	✓	*1	*1		48	*1 HDBaseT supports 4K 24/25/30Hz 4:2:2 only	
	4K-UHD (3840x2160)	25	✓	✓	✓	*1	*1		50		
	4K-UHD (3840x2160)	30	✓	✓	✓	*1	*1		60		
	4K-UHD (3840x2160)	50	✓	✓ (8 bits)	*2	*3	*3		50	*2 HDBaseT supports 4K 50/60Hz 4:2:0 only	
	4K-UHD (3840x2160)	60	✓	✓ (8 bits)	*2	*3	*3		60	*3 HDMI 1,2 support up to 4:2:2, HDBaseT does not support	

3D formats

Standard		Resolution	V-Freq (Hz)	V-Total	H Freq. (kHz)	Output Frame Rate (Hz)	Input Source		Remarks
							HDMI3/4	Dual-pipe HDMI 3 / 4	
1080p100	Frame Sequential	1920x1080	100.00	1125.00	112.50	100.00	✓		Maintained aspect ratio in 16:9
1080p120	Frame Sequential	1920x1080	120.00	1125.00	135.00	120.00	✓		Maintained aspect ratio in 16:9
WUXGA_100_RB	Frame Sequential	1920x1200	100.00	1258.00	125.72	100.00	✓		Maintained aspect ratio in 16:10
1080p50	Dual Pipe	1920x1080	50.00	1125.00	56.25	100.00		✓	Maintained aspect ratio in 16:9
1080p60	Dual Pipe	1920x1080	60.00	1125.00	67.50	120.00		✓	Maintained aspect ratio in 16:9
WUXGA_50_RB	Dual Pipe	1920x1200	50.00	1258	62.86	100.00		✓	Maintained aspect ratio in 16:10
WUXGA_60_RB	Dual Pipe	1920x1200	60.00	1125.00	74.04	120.00		✓	Maintained aspect ratio in 16:10

Notes

SDI formats

Timing	SDI Link Mode	Signal Standards	Color Encode	Sampling Structure	Bit Depth
NTSC	SD	SMPTE 259M-C 270Mbps SD	YCbCr	4:2:2	10
PAL	SD	SMPTE 259M-C 270Mbps SD	YCbCr	4:2:2	10
1035i60	HD	SMPTE 292M 1.5Gbps HD	YCbCr	4:2:2	10
1080i59	HD	SMPTE 292M 1.5Gbps HD	YCbCr	4:2:2	10
1080i60	HD	SMPTE 292M 1.5Gbps HD	YCbCr	4:2:2	10
1080P30	HD	SMPTE 292M 1.5Gbps HD	YCbCr	4:2:2	10
1080P25	HD	SMPTE 292M 1.5Gbps HD	YCbCr	4:2:2	10
1080i50	HD	SMPTE 292M 1.5Gbps HD	YCbCr	4:2:2	10
1080P24	HD	SMPTE 292M 1.5Gbps HD	YCbCr	4:2:2	10
720P60	HD	SMPTE 292M 1.5Gbps HD	YCbCr	4:2:2	10
720P50	HD	SMPTE 292M 1.5Gbps HD	YCbCr	4:2:2	10
1080Sf25	HD	SMPTE 292M 1.5Gbps HD	YCbCr	4:2:2	10
1080Sf30	HD	SMPTE 292M 1.5Gbps HD	YCbCr	4:2:2	10
1080P50	3G Level A	SMPTE 424M 3Gbps	YCbCr	4:2:2	10
1080P59	3G Level A	SMPTE 424M 3Gbps	YCbCr	4:2:2	10
1080P60	3G Level A	SMPTE 424M 3Gbps	YCbCr	4:2:2	10
1080P50	3G Level B	SMPTE 424M 3Gbps	YCbCr	4:2:2	10
1080P59	3G Level B	SMPTE 424M 3Gbps	YCbCr	4:2:2	10
1080P60	3G Level B	SMPTE 424M 3Gbps	YCbCr	4:2:2	10

Notes

Appendix B: wiring details

Signal inputs and outputs

HDMI 1 and 2

19 way type A connector

1. TMDS Data 2+
2. TMDS Data 2 Shield
3. TMDS Data 2-
4. TMDS Data 1+
5. TMDS Data 1 Shield
6. TMDS Data 1-
7. TMDS Data 0+
8. TMDS Data 0 Shield
9. TMDS Data 0-
10. TMDS Clock+
11. TMDS Clock Shield
12. TMDS Clock-
13. CEC
14. not connected
15. SCL (DDC Clock)
16. SCA (DDC Data)
17. DDC/CEC Ground
18. +5 V Power
19. Hot Plug Detect



HDMI: pin view of panel connector

Notes

DisplayPort

DisplayPort 1.2

Pin 1	ML_Lane 0 (p)	Lane 0 (positive)
Pin 2	GND	Ground
Pin 3	ML_Lane 0 (n)	Lane 0 (negative)
Pin 4	ML_Lane 1 (p)	Lane 1 (positive)
Pin 5	GND	Ground
Pin 6	ML_Lane 1 (n)	Lane 1 (negative)
Pin 7	ML_Lane 2 (p)	Lane 2 (positive)
Pin 8	GND	Ground
Pin 9	ML_Lane 2 (n)	Lane 2 (negative)
Pin 10	ML_Lane 3 (p)	Lane 3 (positive)
Pin 11	GND	Ground
Pin 12	ML_Lane 3 (n)	Lane 3 (negative)
Pin 13	CONFIG1	Connected to Ground1
Pin 14	CONFIG2	Connected to Ground1
Pin 15	AUX CH (p)	Auxiliary Channel (positive)
Pin 16	GND	Ground
Pin 17	AUX CH (n)	Auxiliary Channel (negative)
Pin 18	Hot Plug	Hot Plug Detect
Pin 19	Return	Return for Power
Pin 20	DP_PWR	Power for connector (3.3 V 500 mA)

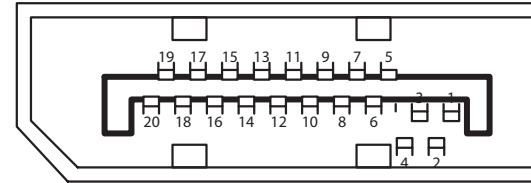
*DisplayPort: pin view of panel connector***Notes**

3G-SDI in, 3G-SDI out

75 ohm BNC



3G-SDI connector

HDBaseT input

RJ45 socket.

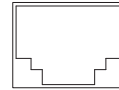

HDBaseT / LAN

Notes

Control connections

LAN

RJ45 socket (Shared with HDBaseT)

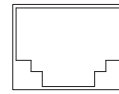

HDBaseT / LAN

RS232

9 way D-type connector

1. unused
2. Transmitted Data (TX)
3. Received Data (RX)
4. unused
5. Signal Ground
6. unused
7. unused
8. unused
9. unused

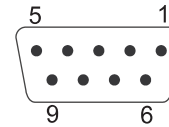

RS232
pin view of female connector

IR input

3.5 mm mini jack

Tip Signal

Ring Not connected

Sleeve Ground

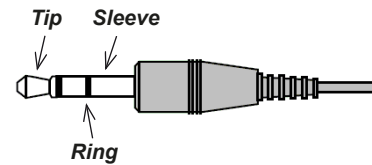

Notes

 Only one remote connection (RS232 or LAN) should be used at any one time.

Appendix C: memory scheme and memory items

Below is a summary of the OSD parameters that can be saved in the memory presets.

Item	Global Memory	Per Input Memory (Preset A/B/C/D)	3D input	Remark
Input Select	☉			
Test Pattern				Not Memorized
Lens Lock / Lens Memory	☉			
DB		☉		
Light Off Timer		☉		Available when DB is set at ON
Brightness		☉	N/A	
Contrast		☉	N/A	
Gamma		☉		Will apply the general gamma when HDR is not activated.
HDR Mode		☉		Will apply the gamma for HDR when auto detected the HDR signal or manual select the PQ-400/PQ-500/PQ-1000/HLG option.
Saturation		☉	N/A	
Hue		☉	N/A	
Sharpness		☉	N/A	
Noise Reduction		☉	N/A	
Freeze			N/A	Not Memorized
Ambient Brightness Correction	☉		N/A	
Color Space		☉	N/A	
Color Mode		☉		
ColorMax		☉		When Color Mode is selected at ColorMax option.
Manual Color Matching		☉		When non-HDR and the Color Mode is selected at Manual Color Matching option.
		☉		When HDR and the Color Mode is selected at Manual Color Matching option.
Color Temperature		☉		When Color Mode is selected at Color Temperature option.
Red Lift		☉		
Green Lift		☉		
Blue Lift		☉		
Red Gain		☉		
Green Gain		☉		
Blue Gain		☉		
Aspect ratio		☉	N/A	
Digi Zoom			N/A	
Digi Pan			N/A	Not Memorized and reset to 0 after power cycle
Digi Scan			N/A	

Notes

Item	Global Memory	Per Input Memory (Preset A/B/C/D)	3D input	Remark
OverScan		⊙	N/A	
Warping Mode	⊙			All Geometry/Edge-Blending settings are global
H Keystone	⊙			
V Keystone	⊙			
Rotation	⊙			
Lens Throw Ratio	⊙			
H PinBarrel	⊙			
V PinBarrel	⊙			
4Corner	⊙			
Blanking	⊙			
Arc	⊙			
Customer Warp	⊙			
Edge Blending	⊙			
Black Level	⊙			
3D Format		⊙		
3D Sync		⊙		
3D DarkTime		⊙		
3D SyncOffset		⊙		
3D SyncReference		⊙		
Laser Mode	⊙			
Laser Power	⊙			
Fan Altitude	⊙			
Contrast Brightness	⊙			
MUBC	⊙			
Orientation	⊙			
High Altitude	⊙			
Screen Setting	⊙		N/A	
Auto Power off	⊙			
Auto Power on	⊙			
Schedule Setting	⊙			
Startup Logo	⊙			
Blank Screen	⊙			
Trig 1	⊙		N/A	
Trig 2	⊙		N/A	
Auto Source	⊙		N/A	
Pic. Mute Setting	⊙			
Ir Enable	⊙			

Notes

Item	Global Memory	Per Input Memory (Preset A/B/C/D)	3D input	Remark	Notes
Ir Code	Ⓞ				
OSD Language	Ⓞ				
OSD Menupos	Ⓞ				
OSD Trans	Ⓞ				
OSD Timer	Ⓞ				
Standby Power	Ⓞ				
Instant Startup	Ⓞ				
Standby Period	Ⓞ				
EDID Mode	Ⓞ				
Hotkey Setting	Ⓞ				
Keypad Backlight	Ⓞ				
Smear Reduction	Ⓞ				
Output Frame Rate	Ⓞ		N/A		
Lan DHCP	Ⓞ				
Lan IP	Ⓞ				
Lan Subnet	Ⓞ				
Lan Gateway	Ⓞ				
Lan DNS	Ⓞ				
Lan MAC	Ⓞ				
Lan AMX	Ⓞ				
Artnet Setting	Ⓞ				
PIP Mode	Ⓞ		N/A		
PIP Input	Ⓞ		N/A		
PIP Position	Ⓞ		N/A		

Appendix D: glossary of terms**Notes****1**

1080p

An HDTV resolution which corresponds to 1920 x 1080 pixels (a widescreen aspect ratio of 16:9).

3

3D active glasses

Wireless battery-powered glasses with LCD shutters. Synchronization information is communicated to the glasses by means of an infrared (IR) or radio frequency (RF) emitter which is connected to the Sync Out terminal on the projector. IR or RF pulses are transmitted by the emitter to signal when the left eye and right eye images are being displayed. The glasses incorporate a sensor which detects the emitter's signal and synchronises the left and right eye shutters with the projected image.

3D passive glasses

Passive glasses do not require a power source to work. Light with left-hand polarisation can pass through the left lens and light with right hand polarisation can pass through the right-hand lens. These glasses are used in conjunction with another device which polarizes the image, such as a ZScreen.

A

Adjust lines

A pattern applied to the image where its edge is to be blended with another image. Adjust lines are used to position the projectors in the array during the edge blend process.

Anamorphic lens

A special lens which, when used with the TheaterScope aspect ratio, allows watching 2.35:1 content packed in a 16:9 source.

Aperture

The opening of the lens that determines the angle through which light travels to come into focus.

Aspect ratio

The proportional relationship between the width and the height of the projected image. It is represented by two numbers separated by a colon, indicating the ratio of image width and height respectively: for example, 16:9 or 2.35:1. Not to be confused with resolution.

B

Blanking (projection)

The ability to intentionally turn off, that is, set to black, areas around the edges of the projected image. It is sometimes referred to as “curtains” since it can be used to blank an area of image that literally falls on the curtains at the side of the screen in a movie theater. Usually no image resizing or geometric correction takes place and the “blanked” part of the image is lost. Not to be confused with horizontal and vertical blanking (video signal).

Blanking (video signal)

The section of the video signal where there is no active video data. Not to be confused with blanking (projection).

Blend region

The area of the image that is to overlap with another image in an edge blend setup. Sometimes called overlapping region.

Brightness (electronic control)

A control which adds a fixed intensity value to every pixel in the display, moving the entire range of displayed intensities up or down, and is used to set the black point in the image (see Contrast). In Component Video signals, brightness is the same as luminance.

Brightness (optical)

Describes how ‘bright’ an image that is projected onto a screen appears to an observer.

C

C

Also known as ‘C’, this is the component, or pair of components, of a Component Video signal which describes color difference information.

Chrominance

Also known as ‘C’, this is the component, or pair of components, of a Component Video signal which describes color difference information.

Color difference

In Component Video signals, the difference between specified colors and the luminance component. Color difference is zero for monochrome images.

Color gamut

The spectrum of color available to be displayed.

Color temperature

The position along the black body curve on the chromaticity diagram, normally quoted in Kelvin. It takes into account the preset values for color balance in the service set-up to take up the variations in the prism. The projector allows you to adjust this temperature (i.e. adjust the picture color temperature).

Component video

A three-wire or four-wire video interface that carries the signal split into its basic RGB components or luminance (brightness) and two-color difference signals (YUV) and synchronization signals.

Notes

Contrast (electronic control)

The adjustment of the white point of the image without affecting the black point. This increases the intensity range of the displayed image.

Contrast (optical)

The intensity difference between the darkest and lightest areas of the screen.

Cr, Cb

Color difference signals used with 'Y' for digital Component Video inputs. They provide information about the signal color. Not to be confused with Pr, Pb.

Crop

Remove part of the projected image. Alternatively, fit an image into a frame with a different aspect ratio by removing part of the image. The image is resized so that either its length or its width equals the length or width of the frame, while the other dimension has moved outside the frame; the excess area is then cut out.

D

Dark time

The time inserted between frames when using 3D active glasses, to avoid ghosting caused by switching time between left and right eye.

DDC (Display Data Channel)

A communications link between the source and projector. DDC is used on the HDMI, DVI and VGA inputs. The link is used by the source to read the EDID stored in the projector.

Deinterlacing

The process of converting interlaced video signals into progressive ones.

DHCP (Dynamic Host Configuration Protocol)

A network protocol that is used to configure network devices so that they can communicate on an IP network, for example by allocating an IP address.

DMD™ (Digital Micromirror Device™)

The optical tool that transforms the electronic signal from the input source into an optical image projected on the screen. The DMD™ of a projector has a fixed resolution, which affects the aspect ratio of the projected image. A Digital Micromirror Device™ (DMD™) consists of moving microscopic mirrors. Each mirror, which acts as a pixel, is suspended between two posts by a thin torsion hinge. It can be tilted to produce either a bright or dark pixel.

E

Edge blend

A method of creating a combined image by blending the adjoining edges of two or more individual images.

Notes

Edge tear

An artifact observed in interlaced video where the screen appears to be split horizontally. Edge tears appear when the video feed is out of sync with the refresh rate of the display device.

EDID (Extended Display Identification Data)

Information stored in the projector that can be read by the source. EDID is used on the HDMI, DVI and VGA inputs, allowing the source to automatically configure to the optimum display settings.

EDTV (Enhanced Definition Television)

A progressive digital television system with a lower resolution than HDTV.

F**Field**

In interlaced video, a part of the image frame that is scanned separately. A field is a collection of either all the odd lines or all the even lines within the frame.

Frame

One of the many still images displayed in a sequence to create a moving picture. A frame is made of horizontal lines of pixels. For example, a 1920x1080 frame consists of 1080 lines, each containing 1920 pixels. In analog video frames are scanned one at a time (progressive scanning) or split into fields for each field to be scanned separately (interlaced video).

Frame rate

The number of frames shown per second (fps). In TV and video, a frame rate is the rate at which the display device scans the screen to “draw” the frame.

Frame rate multiplication

To stop low frame rate 3D images from flickering, frame rate multiplication can be used, which increases the displayed frame rate by two or three times

G**Gamma**

A nonlinear operation used to code and decode luminance. It originates from the Cathode Ray Tube technology used in legacy television sets.

Ghosting

An artifact in 3D image viewing. Ghosting occurs when an image intended for one eye is partially seen by the other eye. Ghosting can be removed by optimizing the dark time and sync delay.

H

HDCP (High-bandwidth Digital Content Protection)

An encryption scheme used to protect video content.

HDTV (High Definition Television)

A television system with a higher resolution than SDTV and EDTV. It can be transmitted in various formats, notably 1080p and 720p.

Hertz (Hz)

Cycles per second.

Horizontal Scan Rate

The rate at which the lines of the incoming signal are refreshed. The rate is set by the horizontal synchronization from the source and measured in Hertz.

Hs + Vs

Horizontal and vertical synchronization.

Hue

The graduation (red/green balance) of color (applicable to NTSC).

I

Interlacing

A method of updating the image. The screen is divided in two fields, one containing every odd horizontal line, the other one containing the even lines. The fields are then alternately updated. In analog TV interlacing was commonly used as a way of doubling the refresh rate without consuming extra bandwidth.

Interleaving

The alternation between left and right eye images when displaying 3D.

L

LED (Light Emitting Diode)

An electronic component that emits light.

Letterboxing

Black margins at the top and bottom of the image. Letterboxing appears when a wider image is packed into a narrower frame without changing the original aspect ratio.

Lumen

A photometric unit of radiant power. For projectors, it is normally used to specify the total amount of emitted visible light.

Notes

Luminance

Also known as 'Y', this is the part of a Component Video signal which affects the brightness, i.e. the black and white part.

N

Noise

Electrical interference displayed on the screen.

NTSC (National Television Standards Committee)

The United States standard for television - 525 lines transmitted at 60 interlaced fields per second

O

OSD (on-screen display)

The projector menus allowing you to adjust various settings.

Overlapping region

The area of the image that is to overlap with another image in an edge blend setup. Sometimes called overlapping region.

P

PAL (Phase Alternate Line)

The television system used in the UK, Australia and other countries - 625 lines transmitted at 50 interlaced fields per second.

Pillarboxing

Black margins at the left and right of the image. Pillarboxing appears when a narrower image is packed into a wider frame without changing the aspect ratio.

Pixel

Short for Picture Element. The most basic unit of an image. Pixels are arranged in lines and columns. Each pixel corresponds to a micromirror within the DMD™; resolutions reflect the number of pixels per line by the number of lines. For example, a 1080p projector contains 1080 lines, each consisting of 1920 pixels.

Pond of mirrors

Area around the periphery of the DMD™ containing inactive mirrors. The pond of mirrors may cause artifacts, for example during the edge blending process.

Pr, Pb

Color difference signals used with 'Y' for analog Component Video inputs. They provide information about the signal color. Not to be confused with Cr, Cb.

Notes

Primary colors

Three colors any two of which cannot be mixed to produce the third. In additive color television systems the primary colors are red, green and blue.

Progressive scanning

A method of updating the image in which the lines of each frame are drawn in a sequence, without interlacing.

Pulldown

The process of converting a 24 fps film footage to a video frame rate (25 fps for PAL/SECAM, 30 fps for NTSC) by adding extra frames. DP projectors automatically carry out reverse pulldown whenever possible.

R**Resolution**

The number of pixels in an image, usually represented by the number of pixels per line and the number of lines (for example, 1920 x 1200).

RGB (Red, Green and Blue)

An uncompressed Component Video standard.

S**Saturation**

The amount of color in an image.

Scope

An aspect ratio of 2.35:1.

SDTV (Standard Definition Television)

An interlaced television system with a lower resolution than HDTV. For PAL and SECAM signals, the resolution is 576i; for NTSC it is 480i.

SECAM (Sequential Color with Memory)

The television system used in France, Russia and some other countries - 625 lines transmitted at 50 interlaced fields per second.

Smooth picture

A feature that can display a higher resolution source than the native resolution of the projector without losing any pixel data.

SX+

A display resolution of 1400 x 1050 pixels with a 4:3 screen aspect ratio. (Shortened from SXGA+, stands for Super Extended Graphics Array Plus.)

Synchronization

A timing signal used to coordinate an action.

Notes

T

Test pattern

A still image specially prepared for testing a projection system. It may contain various combinations of colors, lines and geometric shapes.

TheaterScope

An aspect ratio used in conjunction with a special anamorphic lens to display 2.35:1 images packed into a 16:9 frame.

Throw distance

The distance between the screen and the projector.

Throw ratio

The ratio of the throw distance to the screen width.

TRC (Throw ratio correction)

A special number used in calculating throw distances and throw ratios when the image does not fill the width of the DMD™. TRC is the ratio of the DMD™ aspect ratio to the image source aspect ratio: $TRC = \text{DMD}^{\text{TM}} \text{ aspect ratio} / \text{Source aspect ratio}$ TRC is only used in calculations if it is greater than 1.

U

UXGA

A display resolution of 1600 x 1200 pixels with a 4:3 screen aspect ratio. (Stands for Ultra Extended Graphics Array.)

V

Vertical Scan Rate

The rate at which the frames of the incoming signal are refreshed. The rate is set by the vertical synchronization from the source and measured in Hertz.

Vignetting

Optical cropping of the image caused by the components in the projection lens. This can happen if too much offset is applied when positioning the image using the lens mount.

Vista

An aspect ratio of 1.66:1.

W

WUXGA

A display resolution of 1920 x 1200 pixels with a 16:10 screen aspect ratio. (Stands for Widescreen Ultra Extended Graphics Array.)

Y

Y

This is the luminance input (brightness) from a Component Video signal.

YUV

Color difference signals used with 'Y' for analog Component Video inputs. They provide information about the signal color. Not to be confused with Cr, Cb.

Z

ZScreen

A special kind of light modulator which polarizes the projected image for 3D viewing. It normally requires that images are projected onto a silver screen. The ZScreen is placed between the projector lens and screen. It changes the polarization of the projected light and switches between left- and right-handed circularly polarized light at the field rate.

Notes

DIGITAL PROJECTION

A Delta Associate Company

Contact Information:

Digital Projection Limited

Greenside Way, Middleton,
Manchester, M24 1XX, UK

*Registered in England No.
2207264*

Registered Office: As Above

Tel: (+44) 161 947 3300
Fax: (+44) 161 684 7674

enquiries@digitalprojection.co.uk
service@digitalprojection.co.uk

www.digitalprojection.co.uk

Digital Projection Inc.

55 Chastain Road, Suite 115,
Kennesaw, GA 30144, USA

Tel: (+1) 770 420 1350
Fax: (+1) 770 420 1360

powerinfo@digitalprojection.com

www.digitalprojection.com

Digital Projection China

中国 北京市朝阳区 芍药居北
里 101号 世奥国际中心 A座 2301
室 (100029)

Rm A2301, ShaoYaoJu 101 North
Lane, Shi Ao International Center,
Chaoyang District, Beijing 100029,
PR CHINA

Tel: (+86) 10 84888566
Fax: (+86) 10 84888566-805

techsupport@dp-china.com.cn

www.dp-china.com.cn

Digital Projection Asia

16 New Industrial Road, #02-10
Hudson Technocentre, Singapore
536204

Tel: (+65) 6284-1138
Fax: (+65) 6284-1238

www.digitalprojectionasia.com

Digital Projection Japan

〒105-0012 東京都港区芝大門
2-1-14

2-1-14 Shibadaimon, Minato-ku,
Tokyo, Japan 105-0012

japan@digitalprojection.co.uk

www.digitalprojection.com/jp

Digital Projection Taiwan

186 Ruey Kuang Rd, Neihsu
District, Taipei, 114 Taiwan

Tel: +886-8797-2088 x8854

Taiwan@digitalprojection.co.uk

Digital Projection Korea

1511, Byucksan Digital Valley 6-
cha, Gasan-dong, Geumcheon-
gu, Seoul, Korea

Tel: (+82) 2 515 5303 #1417

Korea@digitalprojection.co.uk

Digital Projection FZE

Unit B4, Light Industrial Units 4,
Silicon Oasis, Dubai, UAE

Tel: +971 43300800

enquiries@digitalprojection.co.uk

www.digitalprojection.com

Digital Projection India

india@digitalprojection.co.uk